

# LED Strip

## 2026 Catalogue



BEYOND LIGHT..  
TO THE LAST DETAILS!



**BEYOND LIGHT..  
TO THE LAST DETAILS!**

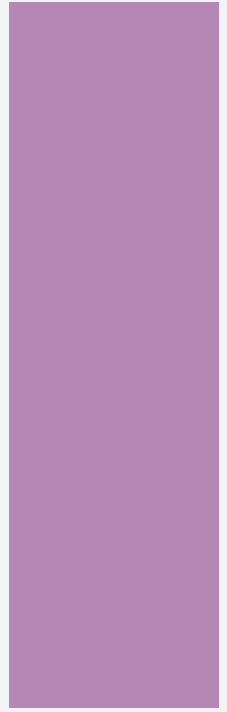

We strive to be  
the leader in the industry  
and the world's most  
respected lighting solution  
provider.

## ILLUS Lighting

ILLUS dedicates itself to provide human oriented architectural lighting solution and products for indoor and outdoor applications. A truly innovative company, ILLUS has always been at the forefront of professional office lighting since inception. Since then ILLUS continues developing innovative, custom lighting solutions that meet extremely exacting requirements in terms of ergonomics, economic efficiency and environmental compatibility and also deliver aesthetic added value to our customers. Our customers will always find that our solutions reflect the requirements satisfying a broad range of customer needs for every lighting application ILLUS is a brand that helps revealing the beauty around you where it constitutes of products and solutions designed with care and attention to detail giving professional quality products.

Our goal has always been to offer our customers a first-class product backed by unparalleled service, focused on solving our client's illumination challenges.

## Our Vision

In ILLUS every detail created with enthusiasm constantly evolving technology to simplify the life of people. We consistently innovate and devote to decrease power consumption to ease the burden of earth. Light is essential for people's life quality and well-being, we care for every situation people need artificial light whenever light serves. ILLUS lighting is beyond light, to the last details.

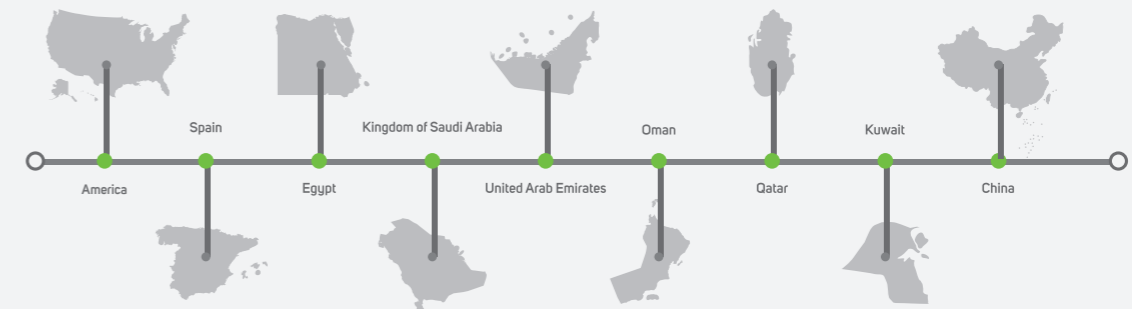

## Where to find us

### Kingdom of Saudi Arabia-Head Office

3533 Al Kharj Rd, Al Aziziyah, Riyadh 14511  
<https://maps.app.goo.gl/TRgDmL4efaDRzWWL8>

### China – illus

Star Alliance, No.68 Zhongxing Avenue, Guzhen, Zhongshan,Guangdong, China  
<https://maps.app.goo.gl/cJJefWvYRyfzAQjq8>

### Spain – illus

46970 Alaquàs, Valencia, Spain  
<https://goo.gl/maps/C5DejH52sP17L2Nv9>

### UAE – Build Station

75 6th St - Al Quoz - Dubai - United Arab Emirates  
<https://goo.gl/maps/LCTSSYSqEB2mcAbA8>

### Kingdom of Bahrain

7J3Q+R36, Arad, Bahrain  
<https://maps.app.goo.gl/e2wceYwDusnepts7>

### Qatar – Build Station

Zone 43, Street 340, Salwa Rd, Doha, Qatar  
<https://maps.app.goo.gl/hQY8PbFDPbXKYiqJ6>

### Oman – Build Station

18 November Street 411 Muscat, Al Aziba, 130, Oman  
<https://goo.gl/maps/6tJLBVdhiVPvUE1w7>

### Kuwait –Lighting Stores

No 4, Opposite the city center entrance, 142 8 St, Shuwaikh Industrial, Kuwait  
Lighting Stores - Google Maps

### Egypt -illus

13 El Obour Bldgs. Salah Salem – Masr El-Gedida - Cairo  
30° 04'40.0"N 31° 18'36.7"E - Google Maps



## R&D and Manufacturing

### Manufacturing

ILLUS has two directly-operated production bases in Yangzhou covering an area of 25,000 square meters and 300 staffs. The production bases contain over 30 hi-speed automatic encapsulation lines, 15 automatic SMD and applied welding lines, 5 automatic extrusion lines and 6 automatic luminaire production lines, characterizing a complete production process for LED strip inclusive of LED encapsulation, hi-speed SMT, automatic welding and full series of water resistance with average monthly production capacity of LED strips reaching up to 1.5 million meters. Besides, ILLUS modernized manufacturing factory to achieve a complete production process for linear luminaire inclusive of precision machining, automatic assembly, color spraying and free customization with average monthly production capacity reaching up to 120,000 strips in order to assure customers of high-quality, super cost-effective products and rapid delivery.



### R&D

ILLUS has established a R&D expert team composed of over 50 core technicians, a majority of which graduated from top-rated universities and are proficient in such fields as optics, technique, material science, electrics, thermal physics, intelligent control and industrial design with more than 10years R&D experience and technical know-how in linear lighting.



#### Laboratory & Inspection

Laboratory of ILLUS, covering an area of 460 square meters, was outfitted with 48 sets of equipment which was distributed as per safety zone, EMC zone, photoelectric zone, IP water resistance zone, aging zone and product reliability zone. Inspection covers products inclusive of LED strip, neon strip, linear luminaire, power supply and related accessories, with inspection standard ranging from safety, EMC, performance to product reliability. Testing reports can be tracked all the way from product design evaluation period to type approval period to guarantee quality of products.



#### Patent

ILLUS strives to R&D in product and technology. So far, it has gained 3 invention patents and nearly 100 utility model patents and appearance patents.

# Contents

## LED Strip

- LED Flexible Linear Light (LV)
- LED Flexible Linear Light (HV)
- Silicon Profile
- Aluminum Bar
- Stainless Steel Fixing Channel
- Aluminum Profile

BEYOND LIGHT..  
TO THE LAST DETAILS!

## LED Strip

- LED Flexible Linear Light (LV)
- LED Flexible Linear Light (HV)
- Silicon Profile
- Aluminum Bar
- Stainless Steel Fixing Channel
- Aluminum Profile



## LED Flexible Linear Light (LV)

### Colourist

#### Technical Operating & Electrical Data

IP Rating	IP65, PVC anti-UV
Power	7W/M
LED Quantity	60pcs/meter
Input	DC192V
Maximum Length	50M/Reel (Max connection L=50M)
Cutting Unit	1 meter
Size	15x8mm
Beam Angle	120°

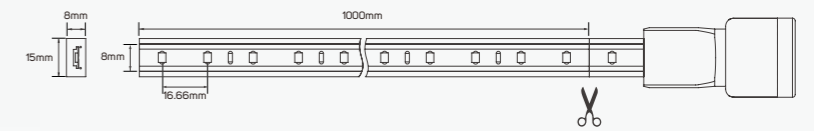

#### Accessories Specifications

##### Dimmer

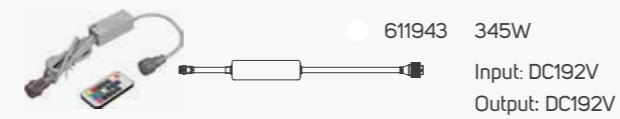

##### Flicker Free Driver

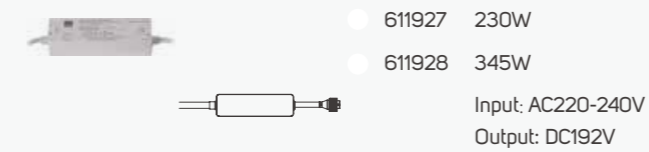

##### Middle Connector

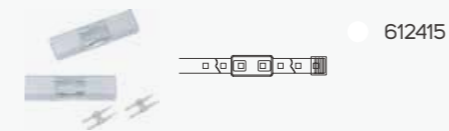

##### Middle Connector

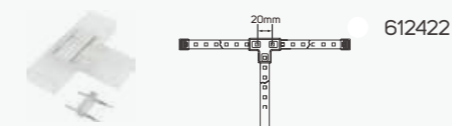

##### Jumper

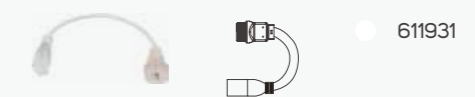

##### Jumper

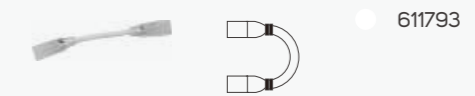

##### Middle Connector



##### PVC Profile

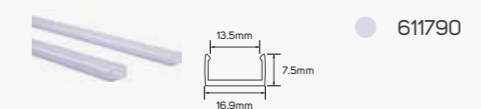

#### Family Product List ■ Aluminum

Code No.	Power	CCT	Lumen	Code No.	Power	CCT	Lumen
611819	7W	1800K	400lm	611823	7W	3500K	630lm
611820	7W	2200K	500lm	611824	7W	4000K	640lm
611821	7W	2700K	600lm	611825	7W	5000K	660lm
611822	7W	3000K	620lm				

■ PVC anti-UV

IP 65 CRI 92

DC192V ⌚ 30,000h

## LED Flexible Linear Light (HV)

### PRODUCT INFORMATION

- Excellently waterproof and anti-dust LED strips with professional design to guarantee lighting performance.
- It not only ensure high quality of lighting color consistency but also protect products outdoor against from harsh environments outdoors.
- ILLUS LED FLEXIBLE LINEAR Light gives the customer the flexibility to choose between 7 CCT based on their specific need with lumen package from 400 lm to 660 lm.

### BENEFITS

- Water proof and vivid light color.
- Less maintenance cost and less concerns on water invasion.

### FEATURES

- High CRI>92.
- Operating voltage DC192V.

# Colourist

## Technical Operating & Electrical Data

IP Rating	IP65, PVC anti-UV
Power	10W/M
CRI	92
LED Quantity	60pcs/meter
Input	DC226V
Maximum Length	40M / Reel
Cutting Unit	1 meter
Beam Angle	120°
Dimming	Dimmable

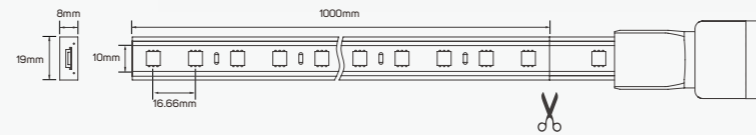

## Accessories Specifications

### RGBW Controller

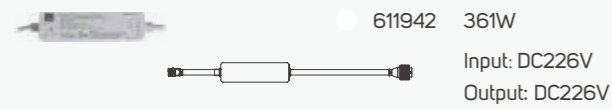

### Jumper



### PVC Profile

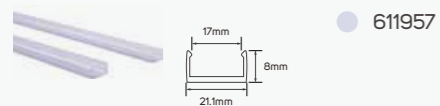

### Jumper



## Family Product List

■ Aluminum

Code No.	Power	CCT	Lumen	
611851	10W	RGB/3000K	150lm	■ PVC anti-UV IP 65 CRI 92 DC226V ⏱ 30,000h

# Colourist

## Technical Operating & Electrical Data

IP Rating	IP65, PVC anti-UV
Power	7W/M
LED Quantity	60pcs/meter
Input	DC226V
Maximum Length	40M / Reel
Cutting Unit	1 meter
Beam Angle	120°
Size	18x8mm
Dimming	Dimmable

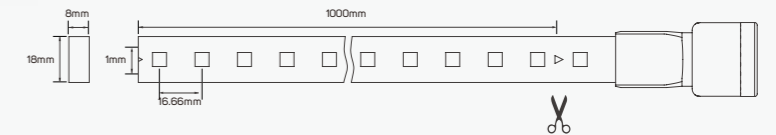

## Accessories Specifications

### RGB Controller

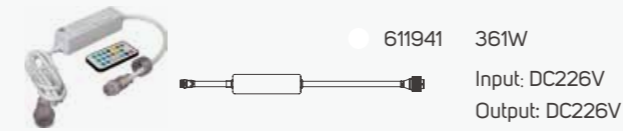

### Jumper

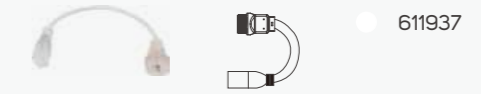

### Middle Connector



### Jumper

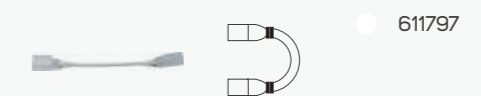

### PVC Profile

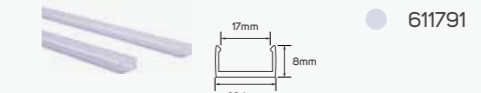

## Family Product List

■ Aluminum

Code No.	Power	CCT	
611850	7W	RGB	■ PVC anti-UV IP 65 DC226V ⏱ 30,000h

# Colourist

## Technical Operating & Electrical Data

IP Rating	IP65, PVC anti-UV
Power	11W/M
LED Quantity	120pcs/meter
Input	DC192V
Maximum Length	40M/Reel (Max connection L=30M)
Cutting Unit	1 meter
Size	18x8mm
Beam Angle	120°

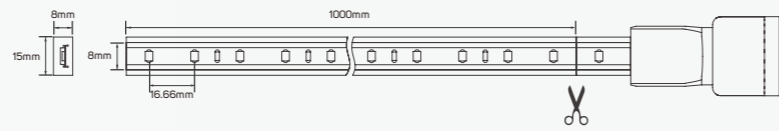

## Accessories Specifications

### Dimmer



● 611943 345W  
Input: DC192V  
Output: DC192V

### Jumper



● 611932

### Flicker Free Driver

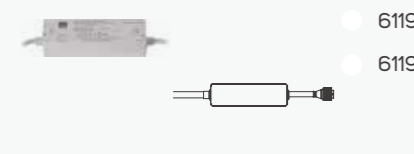

● 611927 230W  
● 611928 345W  
Input: AC220-240V  
Output: DC192V

### Jumper



● 611794

### Middle Connector



● 612416

### Middle Connector



● 612421

### Middle Connector



● 612423

### PVC Profile

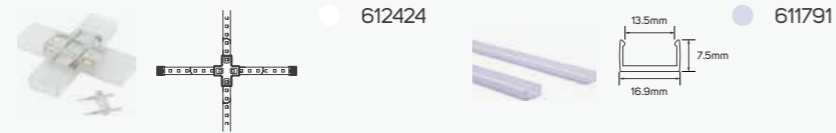

● 612424 ● 611791

## Family Product List

■ Aluminum

Code No.	Power	CCT	Lumen	Code No.	Power	CCT	Lumen
● 611826	11W	1800K	730lm	● 611830	11W	3500K	1080lm
● 611827	11W	2200K	900lm	● 611831	11W	4000K	1100lm
● 611828	11W	2700K	1020lm	● 611832	11W	5000K	1140lm
● 611829	11W	3000K	1060lm				

■ PVC anti-UV

IP 65 CRI 92

□ DC192V ⌚ 30,000h



# Colourist

## Technical Operating & Electrical Data

IP Rating	IP65
Power	6W/12W
Input	DC195
CRI	90
Maximum Length	40M/Reel (6W) & 50M/Reel (12W)
Cutting Unit	1 Meter
Beam Angle	110°

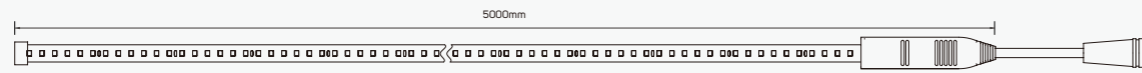

## Accessories Specifications

### Driver

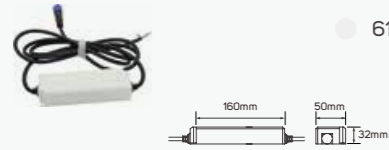

● 613551 250W  
400W  
Input: AC220-240V  
Output: DC195V

### Channel

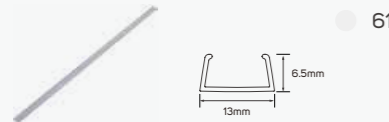

● 613554

### Clip

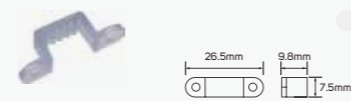

● 613555

### Connector

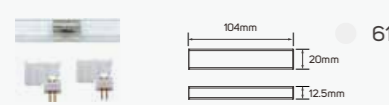

● 613556

### L Connector

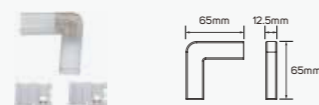

● 613557

### T Connector

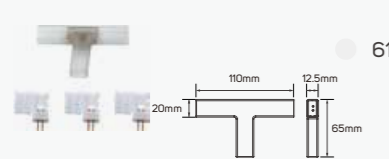

● 613558

### + Connector

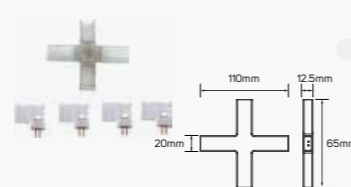

● 613559

## Family Product List

■ Aluminum

Code No.	Power	CCT	Lumen	Code No.	Power	CCT	Lumen
----------	-------	-----	-------	----------	-------	-----	-------

- |          |    |       |       |          |     |       |        |
|----------|----|-------|-------|----------|-----|-------|--------|
| ● 613543 | 6W | 2700K | 580lm | ● 613547 | 12W | 2700K | 1050lm |
| ● 613544 | 6W | 3000K | 590lm | ● 613548 | 12W | 3000K | 1070lm |
| ● 613545 | 6W | 4000K | 620lm | ● 613549 | 12W | 4000K | 1150lm |
| ● 613546 | 6W | 5000K | 640lm | ● 613550 | 12W | 5000K | 1200lm |

■ PVC

IP 65 CRI 90 110°  
DC195V 15,000h





## LED Flexible Neon Flex Linear Light

### PRODUCT INFORMATION

- Excellent LED strips with professional design to guarantee lighting performance.
- It not only ensures high quality of lighting color consistency but also protects products against from harsh environment.
- ILLUS LED FLEXIBLE NEON FLEX LINEAR Light gives the customer the flexibility to choose based on their specific need.

### BENEFITS

- Vivid light color.
- Less maintenance cost and less concerns.

### FEATURES

- Input voltage DC5V.
- Dimmable.
- RGBW.

## LED Flexible Neon Flex Linear Light-RGB Chasing



### Technical Operating & Electrical Data

Current	78mA
Rated Power	8W/M
Power Factor	0.46
Beam Angle	120°
Dimming	Dimmable
IP Rating	IP20
Ambient Temperature	-20°C-45°C
Input Voltage	DC5V
Lifespan	30000H
Switching Cycle	50000x on/off
Warranty Period	24 Months

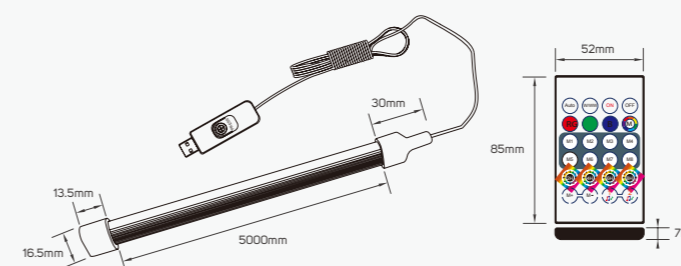

### Family Product List

Code No.	Model No.	Body Color	Body Material	CCT
LI615578	ILS2.5LVNFRGB01	White	PVC	RGBW

PVC  
 IP 20  120°  
 DC5V  30,000h

## Colourist

### Technical Operating & Electrical Data

IP Rating	IP65
Power	9W/12W
CRI	95
Input	DC225V
Cutting Unit	500mm
Beam Angle	120°

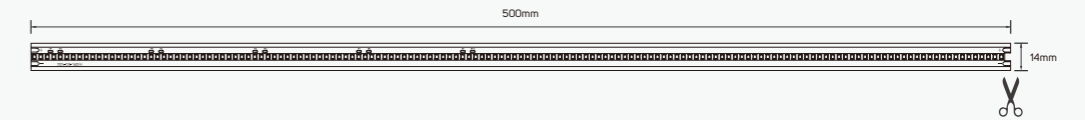

### Accessories Specifications

#### Driver

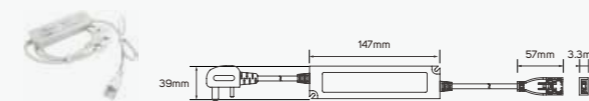

- 614045 250W
  - 614046 400W
- Input: AC230V

#### Connector

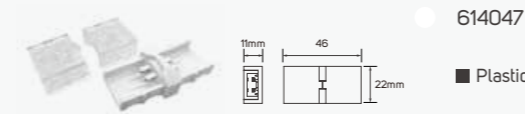

● 614047

■ Plastic

#### Connector



● 614048

■ Plastic

### Family Product List

■ Aluminum

Code No.	Power	CCT	Lumen	Code No.	Power	CCT	Lumen
● 614037	9W	2700K	1250lm	● 614041	12W	2700K	1600lm
● 614038	9W	3000K	1270lm	● 614042	12W	3000K	1620lm
● 614039	9W	4000K	1300lm	● 614043	12W	4000K	1650lm
● 614040	9W	5000K	1350lm	● 614044	12W	5000K	1700lm

■ PVC

IP 65 CRI 95 120°

DC225V 30,000h

# Colourist

## Technical Operating & Electrical Data

IP Rating	IP65, PVC
Power	8W/M
LED Quantity	120pcs/meter
Input	DC192V
Maximum Length	40 meters
Cutting Unit	1 meter cuttable
Size	18.5x10.5mm
Beam Angle	120°

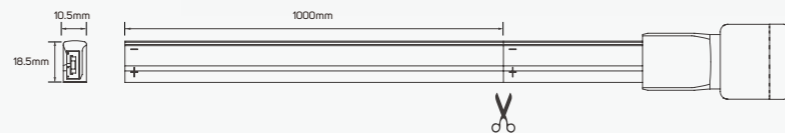

## Accessories Specifications

### Dimmer

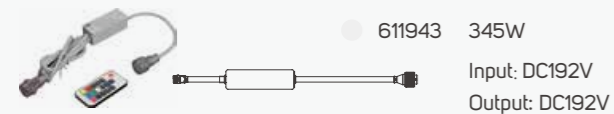

### Flicker Free Driver

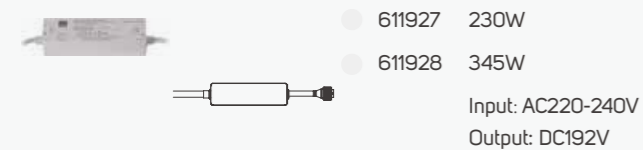

### Middle Connector

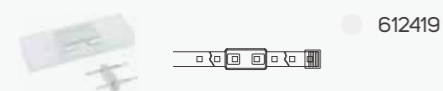

### Aluminum Clip

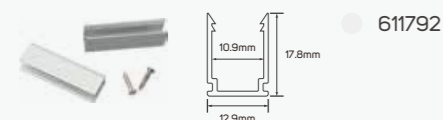

### Jumper



### Jumper



### Aluminum Profile

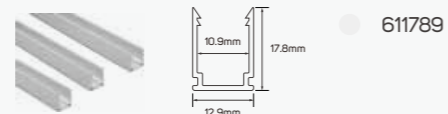

## Family Product List

Code No.	Power	CCT	Lumen	Code No.	Power	CCT	Lumen
611842	8W	1800K	180lm	611847	8W	4000K	300lm
611844	8W	2700K	270lm	611848	8W	5000K	310lm
611846	8W	3500K	290lm				

Aluminum  
 PVC  
 IP 65 CRI 92  
 DC192V ⏱ 30,000h

# Colourist

## Technical Operating & Electrical Data

IP Rating	IP65, PVC
Power	10W/M
LED Quantity	120pcs/meter
Input	DC192V
Maximum Length	40 meters
Cutting Unit	1 meter cuttable
Size	26x15mm
Beam Angle	120°



## Accessories Specifications

### Dimmer

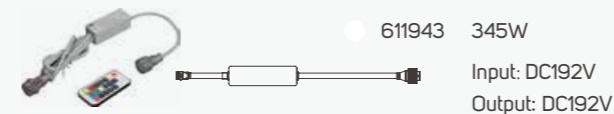

### Flicker Free Driver

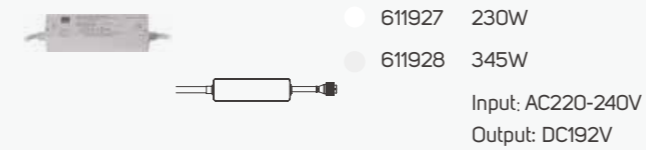

### Middle Connector

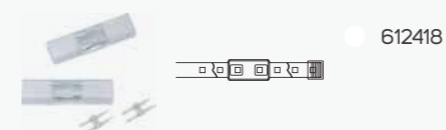

### Aluminum Clip

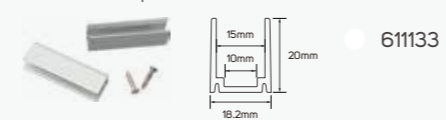

### Jumper



### Jumper



### Aluminum Profile

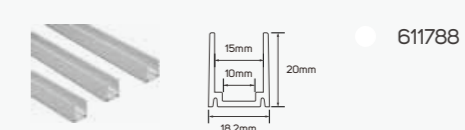

## Family Product List

Code No.	Power	CCT	Lumen	Code No.	Power	CCT	Lumen
611833	10W	1800K	330lm	611838	10W	4000K	480lm
611835	10W	2700K	450lm	611839	10W	5000K	490lm
611837	10W	3500K	470lm				

Aluminum  
 PVC  
 IP 65 CRI 92  
 DC192V ⏱ 30,000h

# Colourist

## Technical Operating & Electrical Data

IP Rating	IP65, PVC
Power	8W/M
LED Quantity	72pcs/meter
Input	DC226V
Maximum Length	40 meters
Cutting Unit	1 meter cuttable
Size	26mmx16mm
Beam Angle	120°

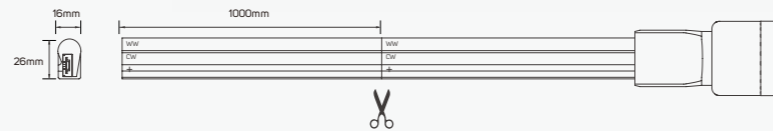

## Accessories Specifications

CCT Controller

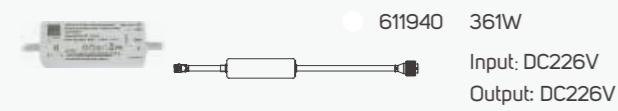

● 611940 361W  
Input: DC226V  
Output: DC226V

Jumper



● 611936

Jumper



● 611977

Aluminum Profile

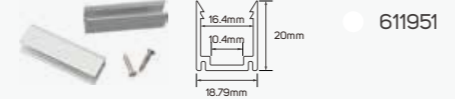

● 611951

## Family Product List

■ Aluminum

Code No.	Power	CCT	Lumen
----------	-------	-----	-------

● 611840 8W 1800K/4500K 210lm@2700K

■ PVC

IP 65 CRI 92

DC226V

30,000h

# Colourist

## Technical Operating & Electrical Data

IP Rating	65, PVC
Power	8W/M
LED Quantity	72pcs/meter
Input	DC226V
Maximum Length	40 meters
Cutting Unit	1 meter cuttable
Size	26x15mm
Beam Angle	120°

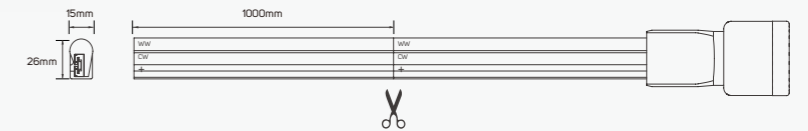

## Accessories Specifications

RGB Controller

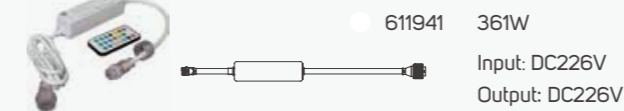

● 611941 361W  
Input: DC226V  
Output: DC226V

Jumper

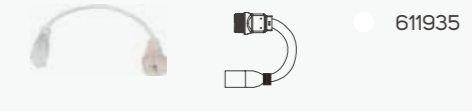

● 611935

Jumper



● 611971

Aluminum Profile

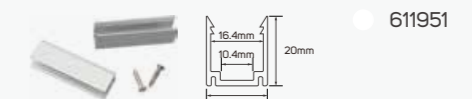

● 611951

## Family Product List

■ Aluminum

Code No.	Power	CCT
----------	-------	-----

● 611841 8W RGB

■ PVC

IP 65

DC226V

30,000h

## Colourist

### Technical Operating & Electrical Data

IP Rating	IP65
Power	10W/M
CRI	95
Input	AC220-240V
Cutting Unit	500mm
Beam Angle	110°
Dimming	Dimmable

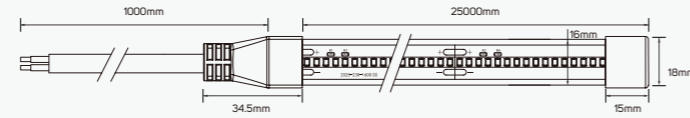

### Accessories Specifications

#### Connector

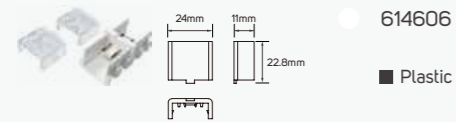

#### Fixing Channel

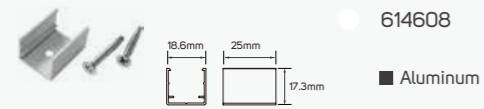

### Family Product List

■ Aluminum

Code No.	Power	CCT	Lumen
614602	10W	2700K	750lm
614603	10W	3000K	760lm
614604	10W	4000K	780lm
614605	10W	5000K	810lm

■ Silicon

IP 65 CRI 95 110°  
AC220-240V 30,000h

## Colourist

### Technical Operating & Electrical Data

IP Rating	IP65, PVC anti-UV
Power	8W/M
LED Quantity	450lm/M+/-10%
Input	DC226V
Maximum Length	40M / Reel
Cutting Unit	1 meter
Size	18x8mm
Beam Angle	120°

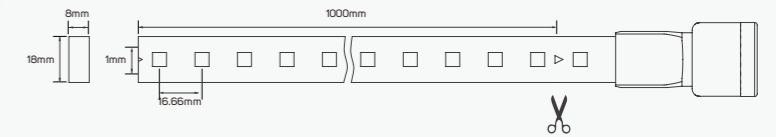

### Accessories Specifications

#### CCT Controller

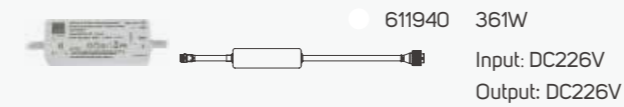

#### Jumper

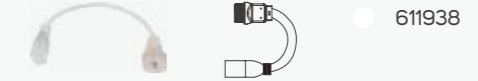

#### Jumper

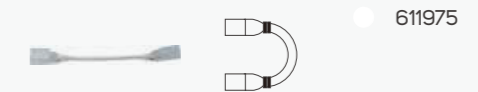

### Family Product List

■ Aluminum

Code No.	Power	CCT	Lumen
611849	8W	2200K/5000K	450lm

■ PVC anti-UV

IP 65 CRI 92  
DC226V 30,000h



LED Flexible Linear Light- Neon Flex (LV)

# NeonGlow

## Technical Operating & Electrical Data

IP Rating	IP67 for strip, Silicon material
Power	9W/M
Lumen	from 320-420lm/M+/-10%
LED Quantity	126pcs/meter
Input	DC24V
Maximum Length	5M/Reel
Cutting Unit	50mm
Size	6x10mm
Packing	Male & female DC connector, 5m/reel into a anti-static bag, 20 bags into a master carton



## Accessories Specifications

### Connector

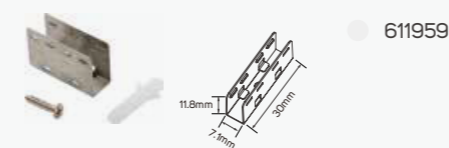

### Connector

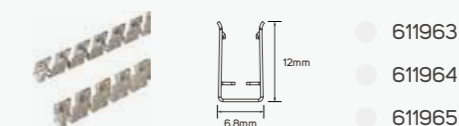

### Connector

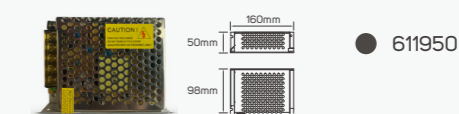
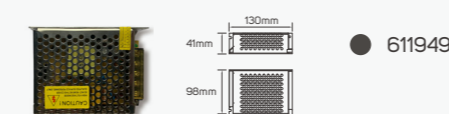
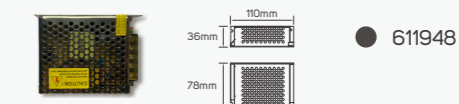
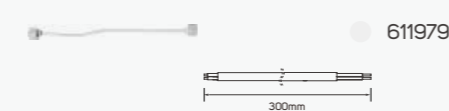

# LED Flexible Linear Light (LV)

## PRODUCT INFORMATION

- Excellently anti-dust LED strips with professional design to guarantee lighting performance.
- It not only ensure high quality of lighting color consistency but also protect products against from harsh environments.
- ILLUS LED FLEXIBLE LINEAR Light gives the customer the flexibility to choose between 6 CCT based on their specific need with lumen package from 320 lm to 420 lm.

## BENEFITS

- Vivid light color.
- Less maintenance cost and less concerns.

## FEATURES

- High CRI>92.
- Operating voltage DC24V.

## Family Product List ■ Aluminum

Code No.	Power	CCT	Lumen	Code No.	Power	CCT	Lumen
611896	9W	2200K	320lm	611899	9W	3500K	400lm
611897	9W	2700K	370lm	611900	9W	4000K	410lm
611898	9W	3000K	390lm	611901	9W	5000K	420lm

IP 67 CRI 92 120°  
DC24V 30,000h

# NeonGlow

## Technical Operating & Electrical Data

IP Rating	IP67
Power	9W/M
LED Quantity	126pcs/meter
Input	DC24V
Maximum Length	5M/Reel
Cutting Unit	50mm
Size	8x12mm
Packing	Male & female DC connector, 5m/reel into a anti-static bag, 20 bags into a master carton

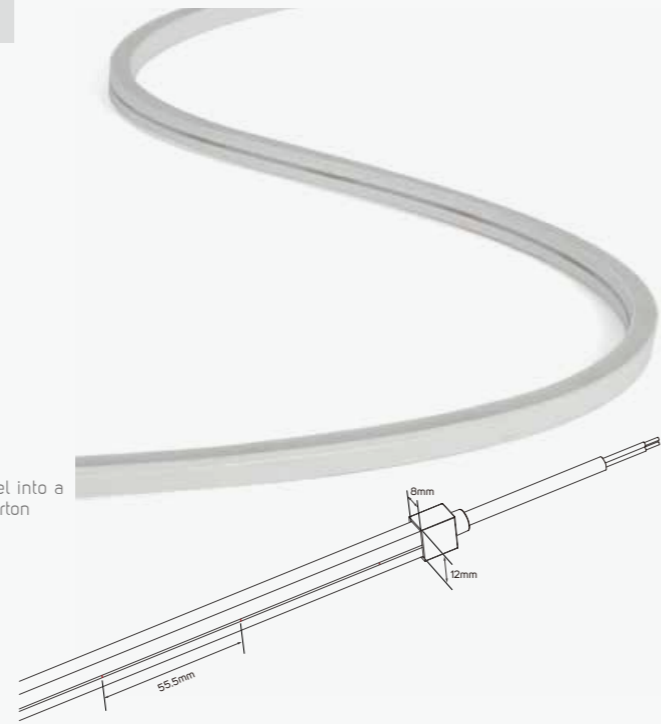

## Accessories Specifications

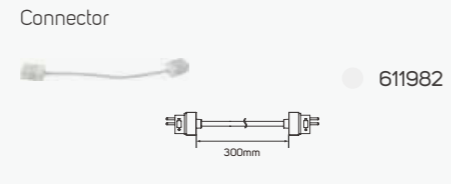
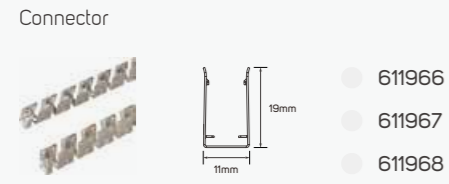
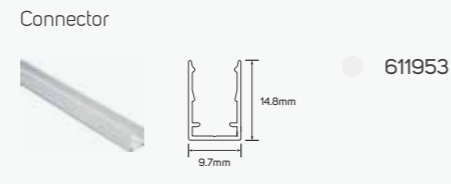
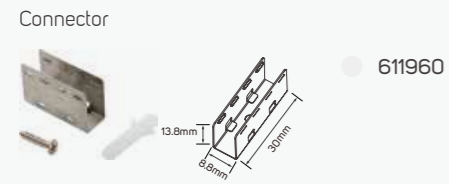

## Family Product List

■ Aluminum

Code No.	Power	CCT	Lumen	Code No.	Power	CCT	Lumen
611903	9W	2200K	320lm	611906	9W	3500K	400lm
611904	9W	2700K	370lm	611907	9W	4000K	410lm
611905	9W	3000K	390lm	611908	9W	5000K	420lm

IP 67 CRI 92 120°  
DC24V 30,000h

# NeonGlow

## Technical Operating & Electrical Data

IP Rating	IP67
Power	9W/M
CRI	92
LED Quantity	126pcs/meter
Input	DC24V
Maximum Length	5M/Reel
Cutting Unit	50mm
Size	10x18mm
Packing	Male & female DC connector, 5m/reel into a anti-static bag, 20 bags into a master carton

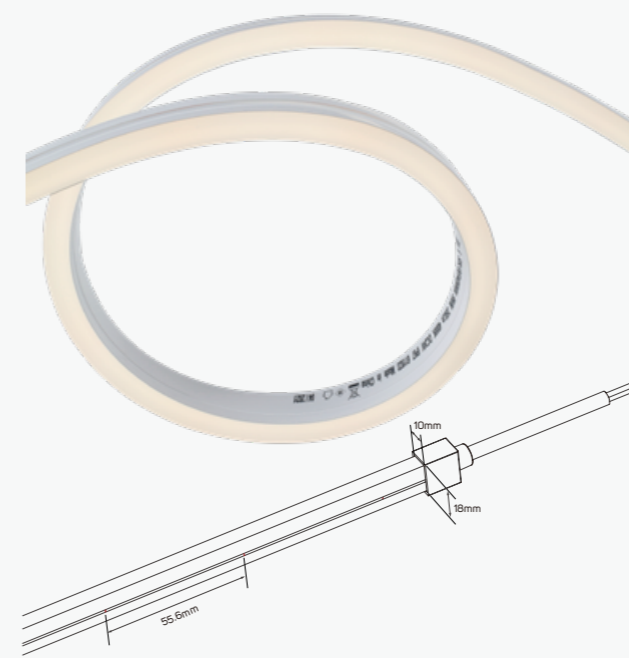

## Accessories Specifications

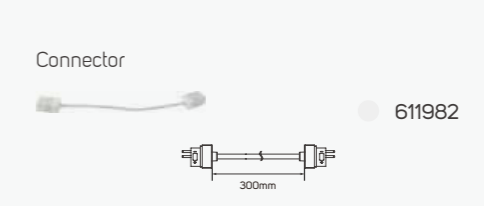
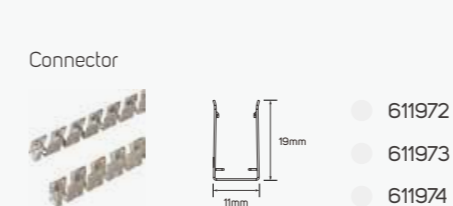
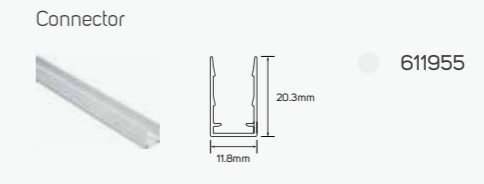
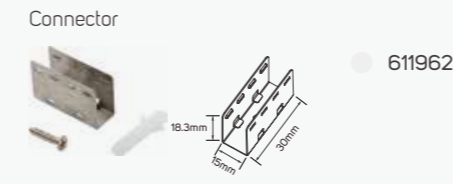

## Family Product List

■ Aluminum

Code No.	Power	CCT	Lumen	Code No.	Power	CCT	Lumen
611919	9W	2200K	270lm	611922	9W	3500K	340lm
611920	9W	2700K	310lm	611923	9W	4000K	350lm
611921	9W	3000K	330lm	611924	9W	5000K	360lm

IP 67 CRI 92 120°  
DC24V 30,000h

# Glow Line

## Technical Operating & Electrical Data

IP Rating	IP20
CRI	95
Beam Angle	140°
Input	DC24V
Size/Reel	5000mm/Reel
Cutting Unit	Free Cutting Size
Lifespan	50000H



## Accessories Specifications

### Connector

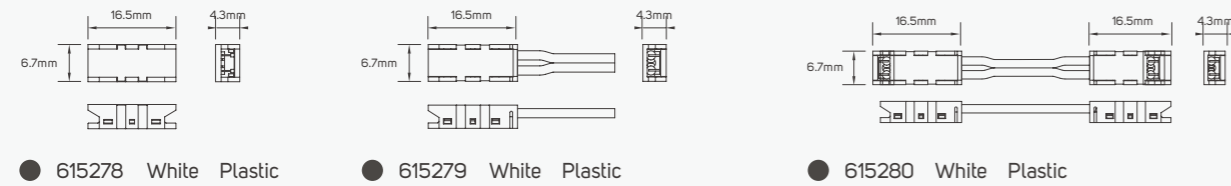

## Family Product List

■ Silicon

Code No.	Power	Max.Power/Reel	Lumen	Efficacy	CCT	
● 615270	5W/M	25W	500lm/M	100lm/W	2700K	<b>IP 20 CRI 95</b> <b>140°</b> DC24V 50,000h
● 615271	5W/M	25W	520lm/M	104lm/W	3000K	
● 615272	5W/M	25W	550lm/M	110lm/W	4000K	
● 615273	5W/M	25W	580lm/M	116lm/W	5000K	
● 615274	7.5W/M	37.5W	800lm/M	106.67lm/W	2700K	
● 615275	7.5W/M	37.5W	830lm/M	110.67lm/W	3000K	
● 615276	7.5W/M	37.5W	870lm/M	116lm/W	4000K	
● 615277	7.5W/M	37.5W	920lm/M	122.67lm/W	5000K	

# Pure Line

## Technical Operating & Electrical Data

IP Rating	IP65
CRI	95
Beam Angle	140°
Input	DC24V
Size/Reel	5000mm/Reel
Cutting Unit	Free Cutting Size
Lifespan	50000H

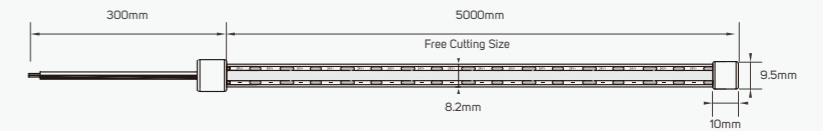

## Accessories Specifications

### Connector

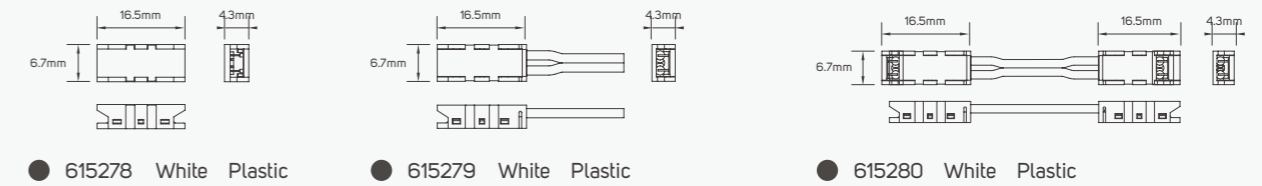

## Family Product List

■ Silicon

Code No.	Power	Max.Power/Reel	Lumen	Efficacy	CCT	
● 615281	5W/M	25W	480lm/M	96lm/W	2700K	<b>IP 65 CRI 95</b> <b>140°</b> DC24V 50,000h
● 615282	5W/M	25W	500lm/M	100lm/W	3000K	
● 615283	5W/M	25W	530lm/M	106lm/W	4000K	
● 615284	5W/M	25W	560lm/M	112lm/W	5000K	
● 615285	7.5W/M	37.5W	780lm/M	104lm/W	2700K	
● 615286	7.5W/M	37.5W	810lm/M	108lm/W	3000K	
● 615287	7.5W/M	37.5W	850lm/M	113.33lm/W	4000K	
● 615288	7.5W/M	37.5W	900lm/M	120lm/W	5000K	



LED Flexible Linear Light (LV)

# Freedom

## Technical Operating & Electrical Data

IP Rating	IP20
Power	16W
LED Quantity	168pcs/meter
Input	DC24V
Maximum Length	5M/Reel
Cutting Unit	Each 7 led per cut (cutting space 4.1 cm)
Size	10x1.2mm (30Z)
Packing	Male & female DC connector, 5m/reel into a anti-static bag, 20 bags into a master carton

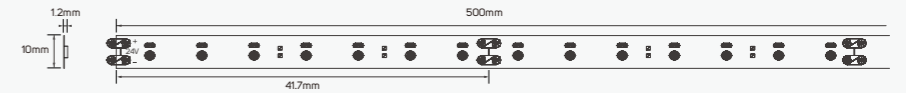

## Accessories Specifications

### Dimmer

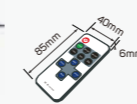

● 611944 144W  
Input: DC24V  
Output: DC24V

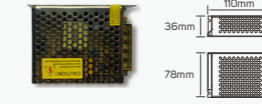

● 611948 75W  
Input: AC220-240V  
Output: DC24V

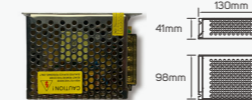

● 611949 100W  
Input: AC220-240V  
Output: DC24V



● 611950 150W  
Input: AC220-240V  
Output: DC24V

## Family Product List ■ Aluminum

Code No.	Power	CCT	Lumen	Code No.	Power	CCT	Lumen	
● 611873	16W	1800K	1050lm	● 611877	16W	3500K	1620lm	IP 20 CRI 95 DC24V
● 611874	16W	2200K	1350lm	● 611878	16W	4000K	1640lm	
● 611875	16W	2700K	1500lm	● 611879	16W	5000K	1680lm	
● 611876	16W	3000K	1600lm					



## LED Flexible Linear Light (LV)

# Freedom

### Technical Operating & Electrical Data

LED Quantity	60pcs/meter
PCB	Double PCB whole thickness 0.25mm, white color, 10mm, copper thickness 25um x 3pcs (30Z)
Chip Size	5.0x5.0x1.2mm
Color Temp	RGB
Input	DC24V
Maximum Length	5M/Reel
Cutting Unit	Each 6 led is cuttable (cutting space 10cm)
Packing	Male & female DC connector, 5m/reel into a anti-static bag, 20 bags into a master carton

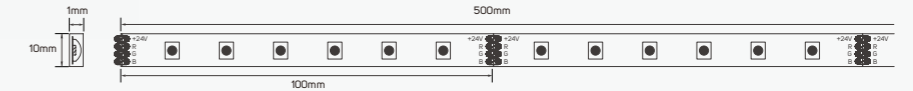

### Accessories Specifications

#### RGB Remote Controller

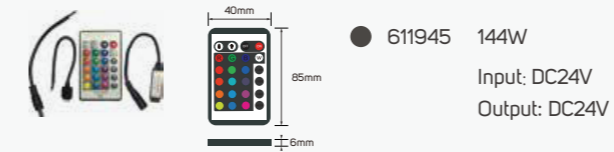

#### Front Connector

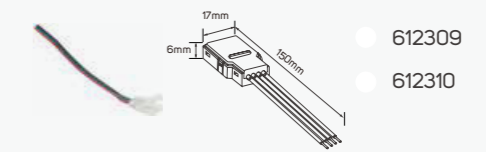

#### Middle Connector

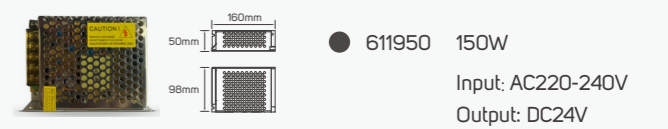
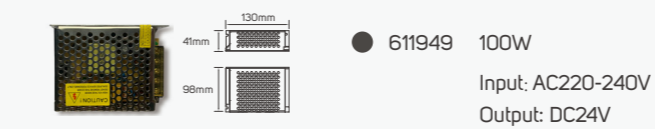
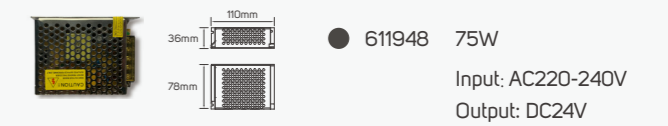
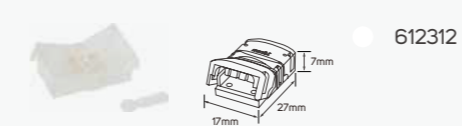

### Family Product List

■ Aluminum

Code No.	Power	CCT	IP 20	120°
● 611891	10W	RGB	□ DC24V	⌚ 30,000h

# NeonGlow

## Technical Operating & Electrical Data

IP Rating	IP67
Power	9W/M
LED Quantity	126pcs/meter
Input	DC24V
Maximum Length	5M/Reel
Cutting Unit	50mm
Size	10x10mm
Packing	Male & female DC connector, 5m/reel into a anti-static bag, 20 bags into a master carton

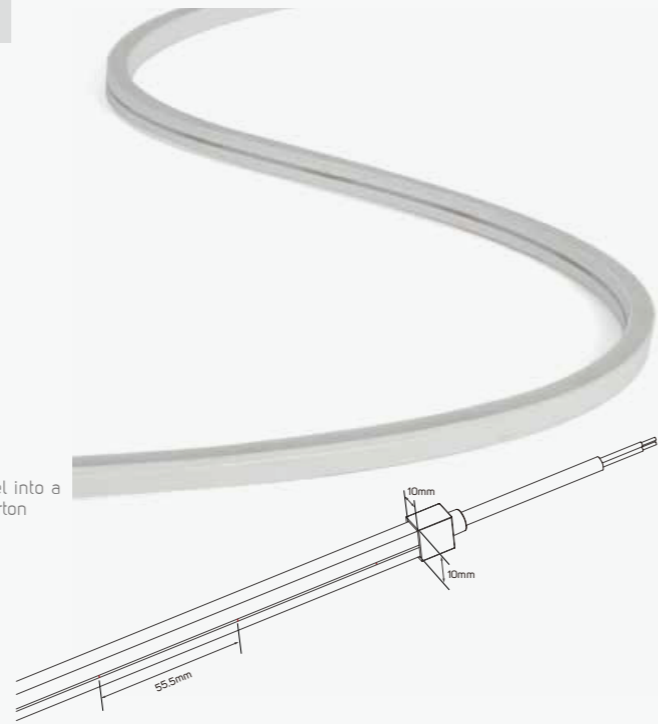

## Accessories Specifications

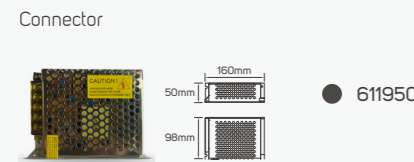
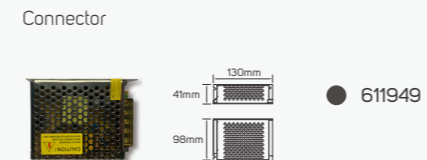
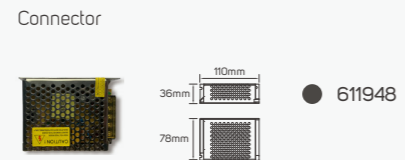
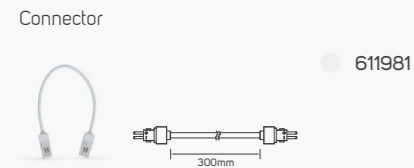
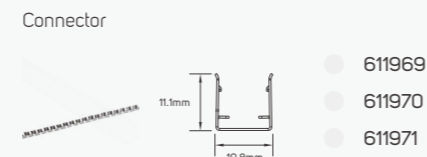
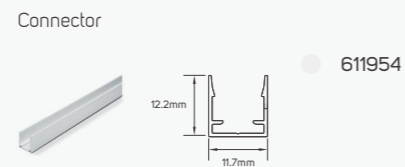
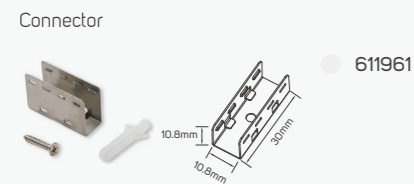

## Family Product List

■ Silicon

Code No.	Power	CCT	Lumen	Code No.	Power	CCT	Lumen
611910	9W	2200K	560lm	611913	9W	3500K	670lm
611911	9W	2700K	640lm	611914	9W	4000K	690lm
611912	9W	3000K	660lm	611915	9W	5000K	700lm

IP 67 CRI 92 120°  
DC24V 30,000h

# NeonGlow

## Technical Operating & Electrical Data

IP Rating	IP67
Power	9W/M
CRI	92
LED Quantity	120pcs/meter
Input	DC24V
Maximum Length	5M/Reel
Cutting Unit	50mm
Size	10x10mm
Packing	Male & female DC connector, 5m/reel into a anti-static bag, 20 bags into a master carton

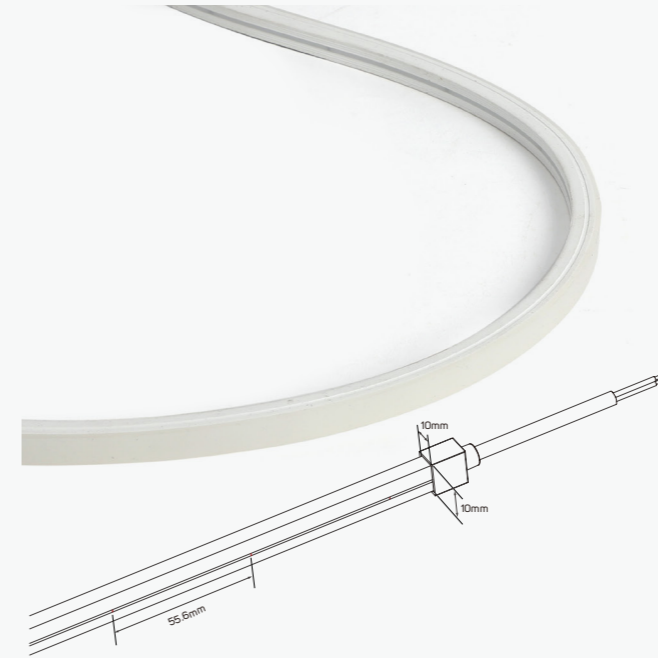

## Accessories Specifications

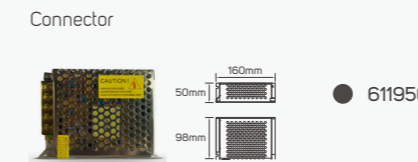
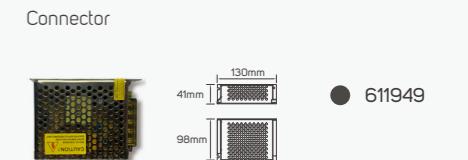
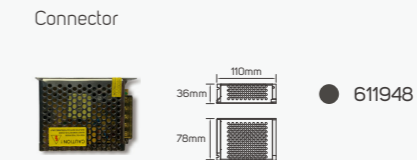
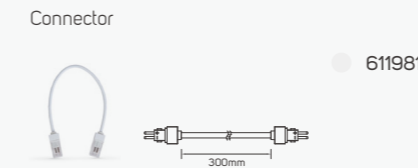
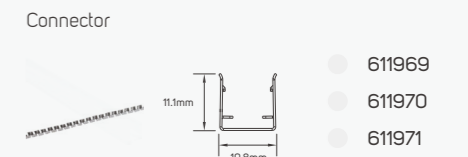
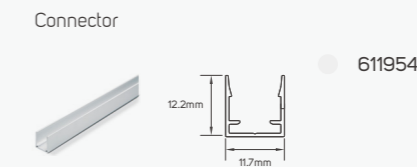
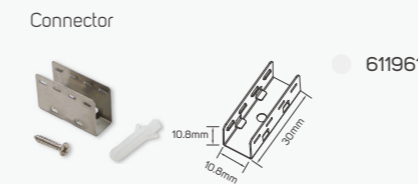

## Family Product List

■ Silicon

Code No.	Power	CCT	Lumen
611916	9W	2200K/5000K	700lm

# Colourist

## Technical Operating & Electrical Data

IP Rating	IP65
Power	9W/M
LED Quantity	72pcs/meter
Input	DC24V
Maximum Length	5M/Reel;
Cutting Unit	50mm
Size	110x18mm
Packing	Male & Female DC connector, 5m/reel into a anti-static bag, 20 bags into a master carton

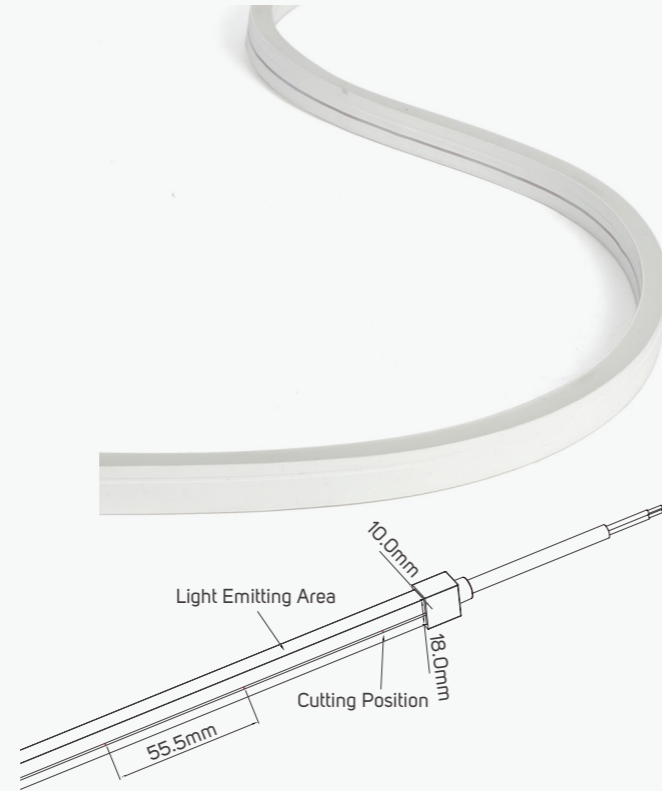

## Accessories Specifications

Connector 611962

Connector 611955

Connector 611972  
611973  
611974

Connector 611984

Connector 611948

Connector 611949

Connector 611950

## Family Product List

■ Silicon

Code No.	Power	CCT	Lumen
----------	-------	-----	-------

● 611926 9W RGB 270lm

IP 65  
DC24V 30,000h

# NeonGlow

## Technical Operating & Electrical Data

IP Rating	IP65
Power	9W/M
CRI	92
LED Quantity	120pcs/meter
Input	DC24V
Maximum Length	5M/Reel
Cutting Unit	50mm
Size	10x10mm
Packing	Male & female DC connector, 5m/reel into a anti-static bag, 20 bags into a master carton

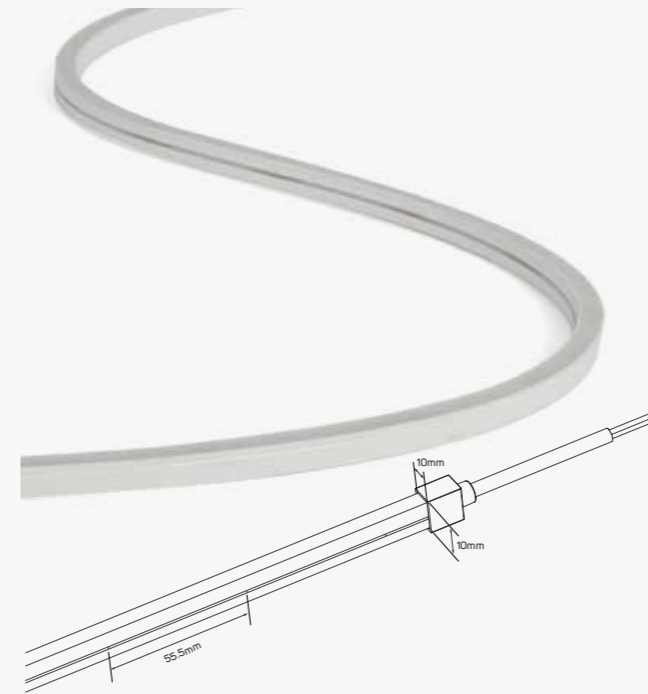

## Accessories Specifications

Connector 611961

Connector 611954

Connector 611969  
611970  
611971

Connector 611984

Connector 611948

Connector 611949

Connector 611950

## Family Product List

■ Silicon

Code No.	Power	CCT
----------	-------	-----

● 611917 9W RGB



LED Flexible Linear Light (LV)

# Freedom

## Technical Operating & Electrical Data

IP Rating	IP20
Power	10W/M
LED Quantity	384pcs/meter
Input	DC24V
Maximum Length	5M/Reel (Max connection L=5M)
Cutting Unit	41.67mm per cut
FPC Board	8mm
Copper Thickness	35um+35um (30Z)
Tape	3M adhesive tape at back of strip
Packing	5m/roll with 15cm male & female DC connector into a anti-static bag, then 40 bags into a master carton

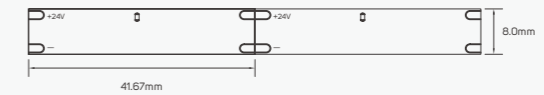

## Accessories Specifications

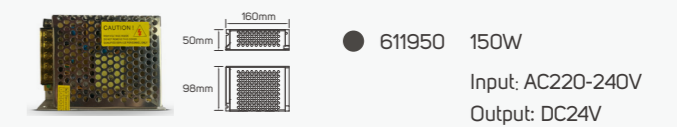
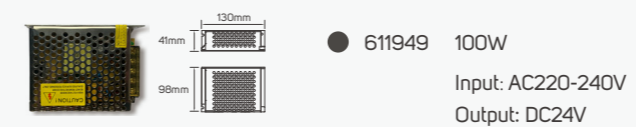
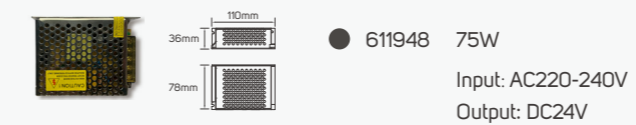
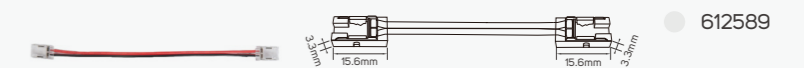
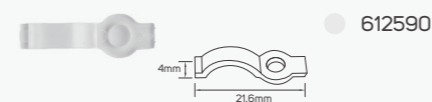
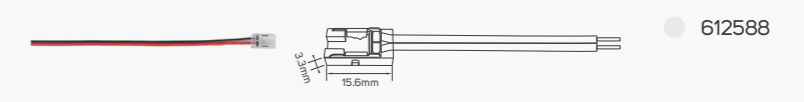
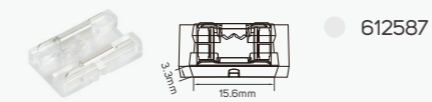

## Family Product List

■ Aluminum

Code No.	Power	CCT	Lumen	Code No.	Power	CCT	Lumen
612497	10W	1800K	450lm	612501	10W	3500K	730lm
612498	10W	2200K	560lm	612502	10W	4000K	740lm
612499	10W	2700K	660lm	612503	10W	5000K	760lm
612500	10W	3000K	700lm				

IP 20 CRI 95  
DC24V



LED Flexible Linear Light (LV)

# Freedom

## Technical Operating & Electrical Data

IP Rating	IP67
Power	10W/M
LED Quantity	384pcs/meter
Input	DC24V
Maximum Length	5M/Reel (Max connection L=5M)
Cutting Unit	41.67mm per cut
FPC Board	8mm
Copper Thickness	35um+35um (30Z)
Tape	3M adhesive tape at back of strip
Packing	5m/roll with 15cm male & female DC connector into a anti-static bag, then 40 bags into a master carton

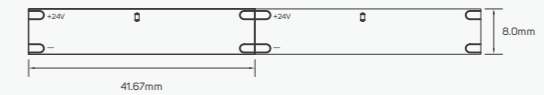
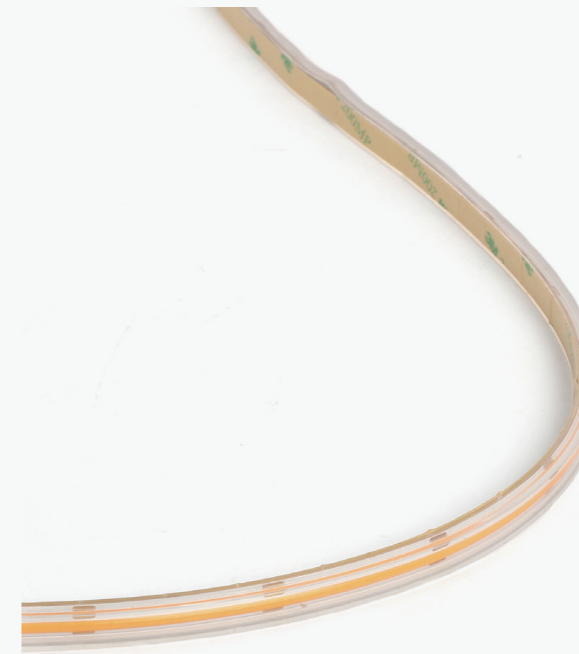

## Accessories Specifications

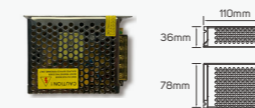

● 611948 75W  
Input: AC220-240V  
Output: DC24V

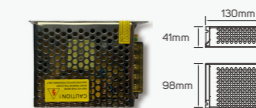

● 611949 100W  
Input: AC220-240V  
Output: DC24V



● 611950 150W  
Input: AC220-240V  
Output: DC24V

## Family Product List ■ Aluminum

Code No.	Power	CCT	Lumen	Code No.	Power	CCT	Lumen	
● 612504	10W	1800K	400lm	● 612508	10W	3500K	660lm	IP 67 CRI 95 □ DC24V
● 612505	10W	2200K	500lm	● 612509	10W	4000K	670lm	
● 612506	10W	2700K	600lm	● 612510	10W	5000K	790lm	
● 612507	10W	3000K	630lm					

# Bright Flow

## Technical Operating & Electrical Data

IP Rating	IP65
CRI	95
Beam Angle	140°
Input	DC24V
Size/Reel	5000mm/Reel
Cutting Unit	Free Cutting Size
Lifespan	50000H



615579 - 615580



615583 - 615585

## Family Product List ■ Silicon

Code No.	Power	Lumen	Efficacy	CCT	
615579	3W/M	300lm/M	100lm/W	2700K	<b>IP 20 CRI 95</b> <b>140°</b> DC24V 50,000h
615580	3W/M	310lm/M	103.33lm/W	3000K	
615583	3W/M	290lm/M	96.67lm/W	2700K	
615585	3W/M	320lm/M	106.67lm/W	4000K	



# Freedom

## Technical Operating & Electrical Data

IP Rating	IP20
Power	8W/M
LED Quantity	126pcs/meter
Input	DC24V
Maximum Length	5M/Reel
Cutting Unit	Each 7 led per cut (cutting space 5cm)
FPCB Size	5x1.2mm (30Z)
Packing	Male & female DC connector, 5m/reel into a anti-static bag, 20 bags into a master carton

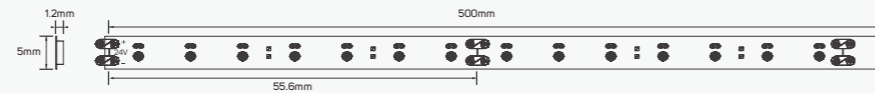

## Accessories Specifications

Dimmer

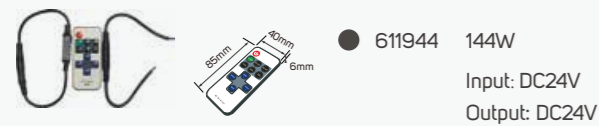

## Family Product List

■ Aluminum

Code No.	Power	CCT	Lumen	Code No.	Power	CCT	Lumen
● 611852	8W	1800K	560lm	● 611856	8W	3500K	850lm
● 611853	8W	2200K	700lm	● 611857	8W	4000K	860lm
● 611854	8W	2700K	790lm	● 611858	8W	5000K	880lm
● 611855	8W	3000K	830lm				

IP 20 CRI 95 120°  
DC24V 30,000h

# Freedom

## Technical Operating & Electrical Data

IP Rating	IP20
Power	10W/M
LED Quantity	126pcs/meter
Input	DC24V
Maximum Length	5M/Reel
Cutting Unit	Each 7 led is cuttable (cutting space 5.5cm)
Chip Size	2.8x3.5x0.8mm
Packing	Male & female DC connector, 5m/reel into a anti-static bag, 20 bags into a master carton

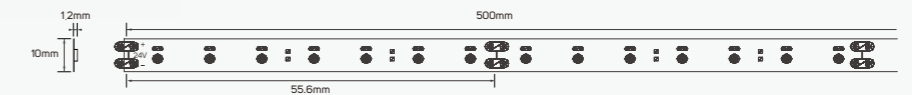

## Accessories Specifications

Dimmer

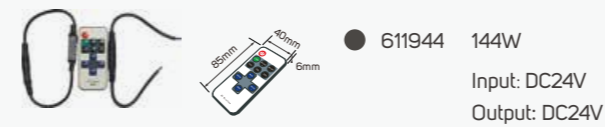

Connector

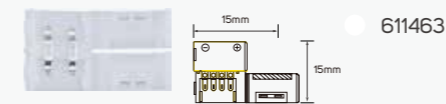

Connector



Connector

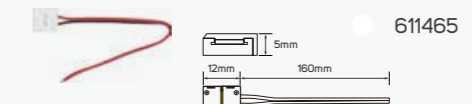

Connector

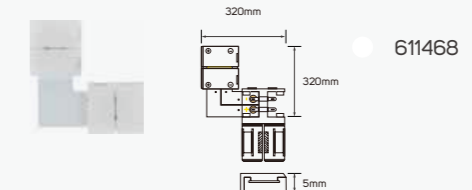

## Family Product List

■ Aluminum

Code No.	Power	CCT	Lumen	Code No.	Power	CCT	Lumen
● 611859	10W	1800K	720lm	● 611863	10W	3500K	1010lm
● 611860	10W	2200K	900lm	● 611864	10W	4000K	1020lm
● 611861	10W	2700K	960lm	● 611865	10W	5000K	1040lm
● 611862	10W	3000K	1000lm				

IP 20 CRI 95 120°  
DC24V 30,000h



## Freedom

### Technical Operating & Electrical Data

IP Rating	IP20
Power	21W
LED Quantity	210pcs/meter
Input	DC24V
Maximum Length	5M/Reel
Cutting Unit	Each 7 led per cut (cutting space 3.3cm)
Size	12x1.2mm (30Z)
Packing	Male & female DC connector, 5m/reel into a anti-static bag, 20 bags into a master carton

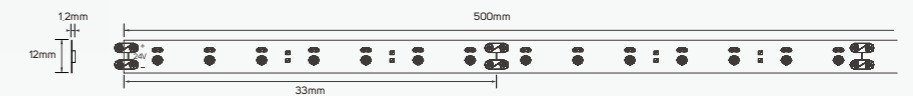

### Accessories Specifications

Dimmer



● 611944 144W  
Input: DC24V  
Output: DC24V

### Family Product List

■ Aluminum

Code No.	Power	CCT	Lumen	Code No.	Power	CCT	Lumen
● 611880	21W	1800K	1400lm	● 611884	21W	3500K	2130lm
● 611881	21W	2200K	1750lm	● 611885	21W	4000K	2160lm
● 611882	21W	2700K	2000lm	● 611886	21W	5000K	2200lm
● 611883	21W	3000K	2100lm				

IP 20 CRI 95 120°  
DC24V 30,000h

# Freedom

## Technical Operating & Electrical Data

IP Rating	IP67
Power	10W/M
LED Quantity	126pcs/meter
Input	DC24V
Maximum Length	5M/Reel
Cutting Unit	Each 7 led is cuttable (cutting space 5.5cm)
Chip Size	2.8x3.5x0.8mm
Packing	Male & female DC connector, 5m/reel into a anti-static bag, 20 bags into a master carton

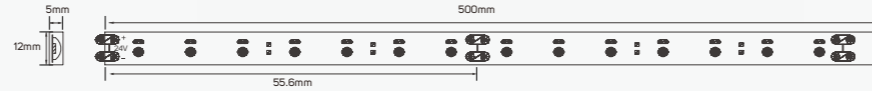

## Accessories Specifications

Dimmer

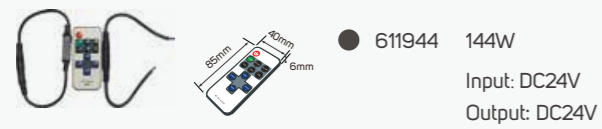

Connector



Connector



Middle Connector

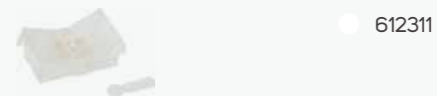

## Family Product List

■ Aluminum

Code No.	Power	CCT	Lumen	Code No.	Power	CCT	Lumen
611866	10W	1800K	640lm	611870	10W	3500K	910lm
611867	10W	2200K	800lm	611871	10W	4000K	920lm
611868	10W	2700K	860lm	611872	10W	5000K	940lm
611869	10W	3000K	900lm				

■ Silicon

IP 67 CRI 95  
DC24V 30,000h

# Freedom

## Technical Operating & Electrical Data

IP Rating	IP20
Power	10W
LED Quantity	126pcs/meter
Input	DC24V
Maximum Length	5M/Reel
Cutting Unit	Each 16 led is cuttable (cutting space 12.5cm)
Chip Size	2.8x3.5x0.8mm
Packing	Male & female DC connector, 5m/reel into a anti-static bag, 20 bags into a master carton
PCB	Double PCB whole thickness 0.25mm, white color, 10mm, copper thickness 25um x 3pcs (3OZ)

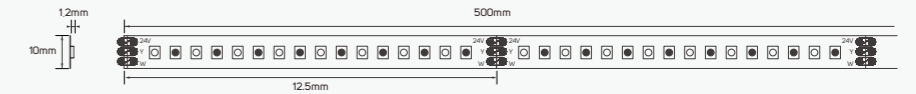

## Accessories Specifications

CCT Controller

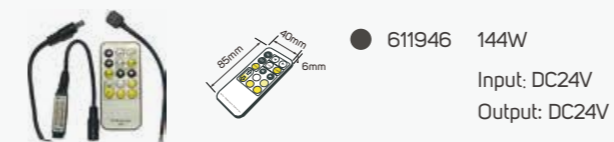

## Family Product List

■ Aluminum

Code No.	Power	CCT	Lumen	IP	CRI	Beam Angle	Life
611887	10W	2200K/5000K	1030lm	IP 20	CRI 95	120°	30,000h

# Freedom

## Technical Operating & Electrical Data

IP Rating	IP67
Power	10W/M
LED Quantity	128pcs/meter
Input	DC24V
Maximum Length	5M/Reel
Cutting Unit	Each 16 led is cuttable (cutting space 12.5cm)
Chip Size	2.8x3.5x0.8mm
Packing	Male & female DC connector, 5m/reel into a anti-static bag, 20 bags into a master carton

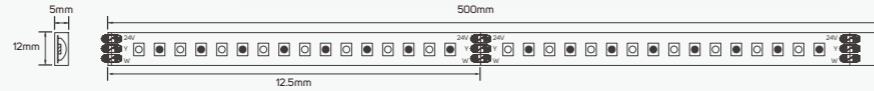

## Accessories Specifications

Dimmer



● 611944 144W  
Input: DC24V  
Output: DC24V

## Family Product List

■ Aluminum

Code No.	Power	CCT	Lumen	IP	CRI	Beam Angle	Life
611888	10W	2200K/5000K	950lm	IP 67	CRI 95	120°	30,000h

# Freedom

## Technical Operating & Electrical Data

LED Quantity	60pcs/meter
PCB	Double PCB whole thickness 0.25mm, white color, 10mm, copper thickness 25um x 3pcs (30Z)
Chip Size	5.0x5.0x1.2mm
Color Temp	RGB
Input	DC24V
Maximum Length	5M/Reel
Cutting Unit	Each 6 led is cuttable (cutting space 10cm)
Packing	Male & female DC connector, 5m/reel into a anti-static bag, 20 bags into a master carton

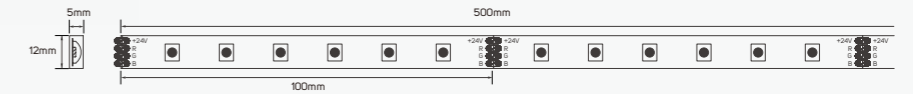

## Accessories Specifications

RGB Remote Controller

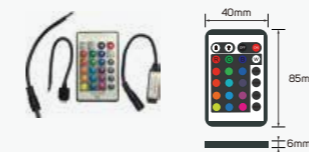

● 611945 144W  
Input: DC24V  
Output: DC24V

Front Connector

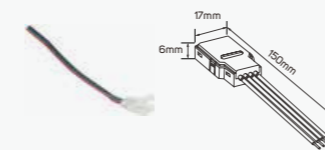

● 612309  
● 612310

Middle Connector



● 612312

## Family Product List

■ Aluminum

Code No.	Power	CCT	IP	Beam Angle	Life
611892	10W	RGB	IP 20	120°	30,000h

# Freedom

## Technical Operating & Electrical Data

IP Rating	IP20
Power	10W/M
CRI	90
LED Quantity	60pcs/meter
Input	DC24V
Maximum Length	5M/Reel
Cutting Unit	Each 6 led is cuttable (cutting space 10cm)
Chip Size	5.0x5.0x1.2mm
Packing	Male & female DC connector, 5m/reel into a anti-static bag, 20 bags into a master carton

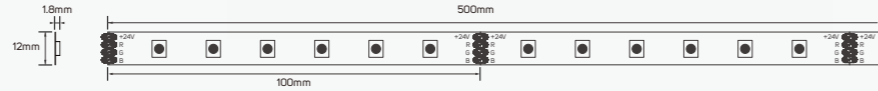

## Accessories Specifications

RGBW Remote Controller

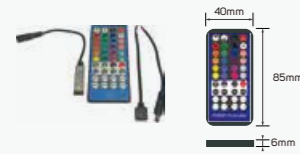

● 611947 144W  
Input: DC24V  
Output: DC24V

## Family Product List

■ Aluminum

Code No.	Power	CCT	Lumen	IP	CRI	Beam Angle	Life
611893	10W	RGB/3000K	170lm	IP 20	CRI 95	120°	30,000h

# Freedom

## Technical Operating & Electrical Data

IP Rating	IP67
Power	10W/M
LED Quantity	60pcs/meter
Input	DC24V
Maximum Length	5M/Reel
Cutting Unit	Each 6 led is cuttable (cutting space 10cm)
Chip Size	5.0x5.0x1.2mm
Packing	Male & female DC connector, 5m/reel into a anti-static bag, 20 bags into a master carton

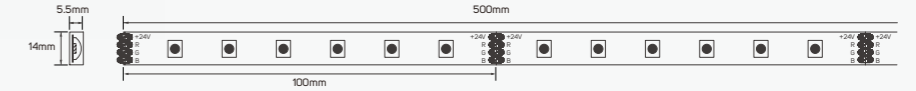

## Accessories Specifications

RGBW Remote Controller

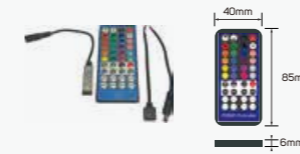

● 611947 144W  
Input: DC24V  
Output: DC24V

## Family Product List

■ Aluminum

Code No.	Power	CCT	Lumen	IP	CRI	Beam Angle	Life
611894	10W	RGB/3000K	170lm	IP 67	CRI 95	120°	30,000h

# Freedom

## Technical Operating & Electrical Data

IP Rating	IP20
Body Material	Silicon
CRI	95
Input	DC24V
Beam Angle	140°
Cutting Unit	500mm
Body Color	Yellow
Life Span	50000hrs

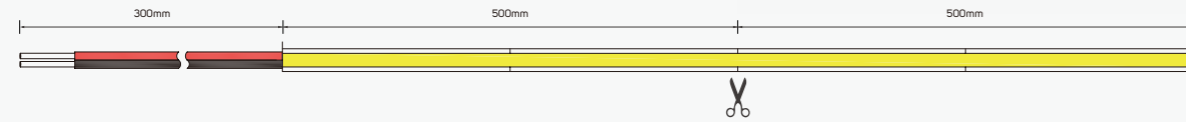

## Accessories Specifications

Connector

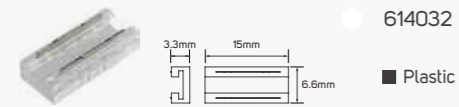

614032

Plastic

Connector

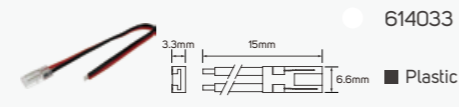

614033

Plastic

Connector

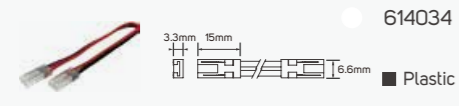

614034

Plastic

## Family Product List

Aluminum

Code No.	Power	CCT	Lumen	Code No.	Power	CCT	Lumen
614008	3W	2700K	320lm	614016	7.5W	2700K	820lm
614009	3W	3000K	330lm	614017	7.5W	3000K	850lm
614010	3W	4000K	370lm	614018	7.5W	4000K	900lm
614011	3W	5000K	390lm	614019	7.5W	5000K	950lm
614012	5W	2700K	540lm				
614013	5W	3000K	560lm				
614014	5W	4000K	620lm				
614015	5W	5000K	650lm				

PCB+Silicon

IP 20 CRI 95 140°  
DC24V 50,000h

# Freedom

## Technical Operating & Electrical Data

IP Rating	IP65
Body Material	Silicon
CRI	95
Input	DC24V
Beam Angle	140°
Cutting Unit	500mm
Body Color	Yellow
Life Span	50000hrs

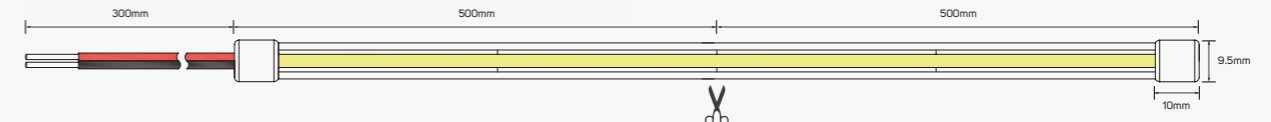

## Accessories Specifications

Connector

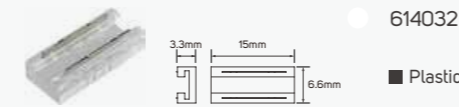

614032

Plastic

Connector

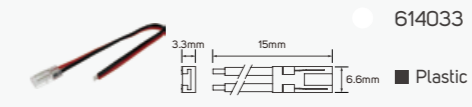

614033

Plastic

Connector

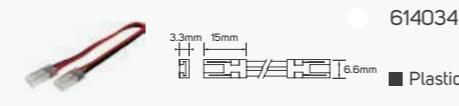

614034

Plastic

## Family Product List

Aluminum

Code No.	Power	CCT	Lumen	Code No.	Power	CCT	Lumen
614020	3W	2700K	310lm	614028	7.5W	2700K	770lm
614021	3W	3000K	320lm	614029	7.5W	3000K	800lm
614022	3W	4000K	350lm	614030	7.5W	4000K	850lm
614023	3W	5000K	370lm	614031	7.5W	5000K	900lm
614024	5W	2700K	520lm				
614025	5W	3000K	540lm				
614026	5W	4000K	590lm				
614027	5W	5000K	620lm				

PCB+Silicon

IP 65 CRI 95  
DC24V 50,000h

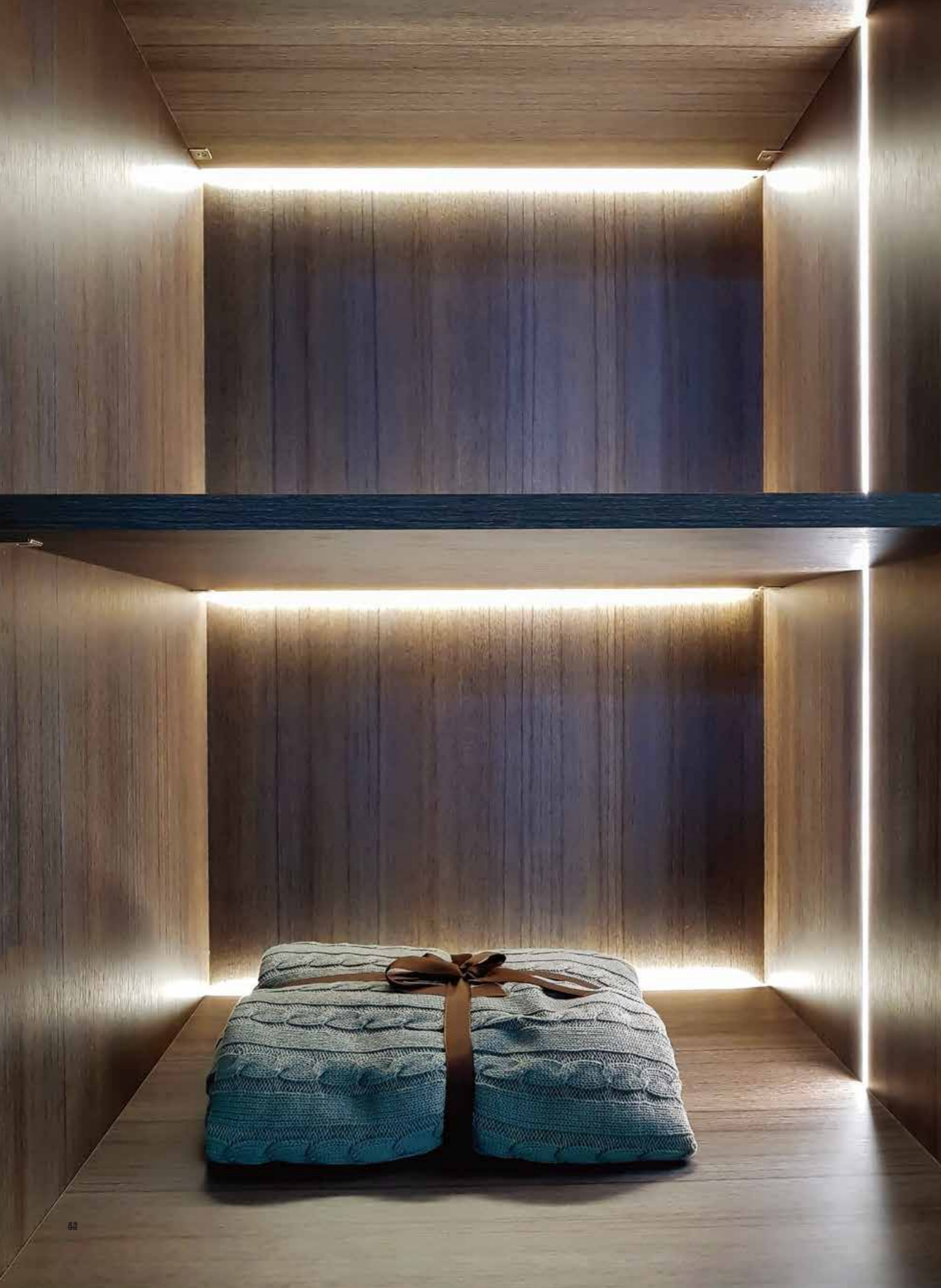

LED Flexible Linear Light(High Lumen Wall Washer)

# Everglow

## Technical Operating & Electrical Data

IP Rating	IP65
Body Material	Silicon
CRI	90
Input	DC24V
Beam Angle	36°
Dimming	Non- Dimmable
Lifespan	30000H
High Lumen	1250lm



### Accessories Specifications

Endcap



● 614936

Channel



● 614937

Profile



● 614938

Channel



● 614939

Bracket



● 614940

Bracket



● 614941

### Family Product List

■ Aluminum

Code No.	Power	CCT	Lumen	IP 65	CRI 90	36°	DC24V	30,000h
● 614932	17W	3000K	1150lm					
● 614933	17W	4000K	1250lm					
● 614934	17W	3000K	950lm					
● 614935	17W	4000K	1050lm					

# Infinite

## Technical Operating & Electrical Data

IP Rating	IP65
Power	15W
CRI	95
Input	DC24V
Beam Angle	360°
Cutting Size	6MM



## Accessories Specifications

Endcap



● 614924

Kit



● 614927

Ceiling Kit



● 614930

Clip



● 614925

Kit



● 614928

Ceiling Kit



● 614931

Clip



● 614926

Pipe



● 614929

## Family Product List ■ Aluminum

Code No.	Power	CCT	Lumen	IP 65	CRI 95	360°
● 614922	15W	3000K	950lm	☑ DC24V	⌚ 30,000h	
● 614923	15W	4000K	1050lm			





## S7 Series

### Technical Operating & Electrical Data

IP Rating	IP20
Power	7W
CRI	95
Input	DC24V
Beam Angle	120°

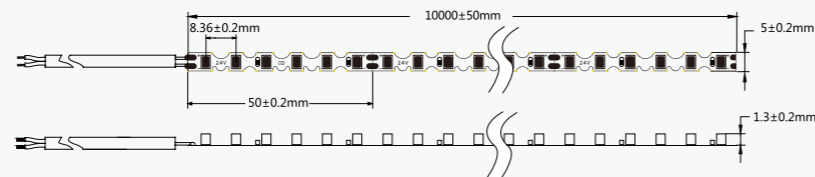

### Accessories Specifications

#### Dimmer



● 614407

● 614408

### Family Product List

■ Aluminum

Code No.	Power	CCT	Lumen	IP 20	CRI 95	120°	DC24V	50,000h
614403	7W	2000K	700lm					
614404	7W	3000K	720lm					
614405	7W	4000K	750lm					
614406	7W	5000K	780lm					

## Chasing

### Technical Operating & Electrical Data

IP Rating	IP20
Power	9W
Input	DC24V
Beam Angle	160°
CRI	95
Dimming	Dimmable
Efficacy	Up to 72lm/w
Lifespan	50000H

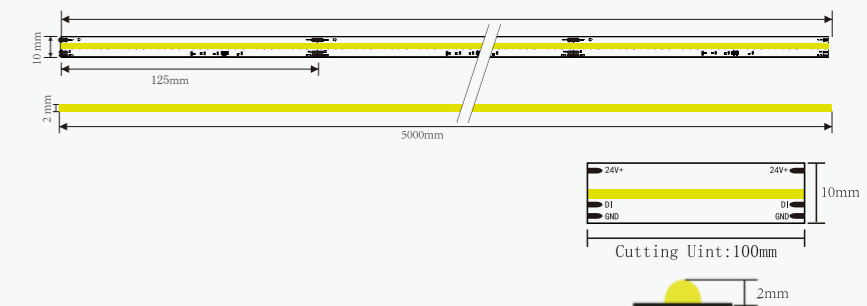

### Accessories Specifications

#### Dimmer



● 614275 144W  
Input: DC24V  
Output: DC24V

### Family Product List

■ Aluminum

Code No.	Power	CCT	Lumen	IP 20	CRI 95	160°	DC24V	50,000h
614272	9W	2700K	570lm					
614273	9W	3000K	600lm					
614274	9W	4000K	650lm					

# WallGlow

## Technical Operating & Electrical Data

IP Rating	IP65
Input	DC24V
CRI	85
Beam Angle	45°
Cutting Size	167MM

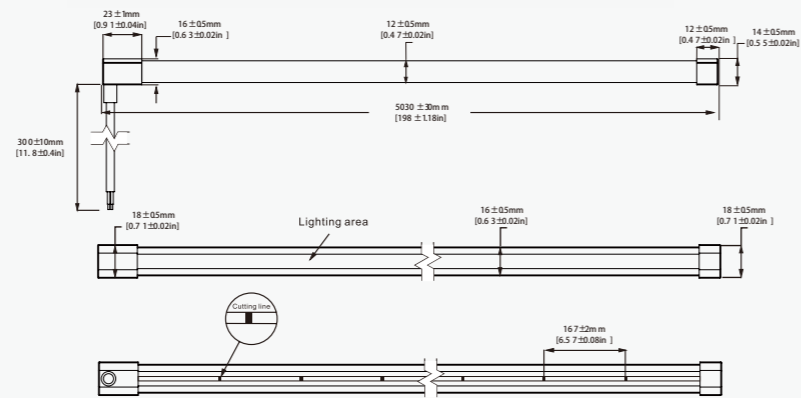

## Accessories Specifications

End Cap



● 614431

Clip



● 614432

## Family Product List

■ Aluminum

Code No.	Power	CCT	Lumen	IP 65	CRI 85	45°	DC24V	50,000h
614514	8.5W/0.5M	3000K	670lm/0.5M					
614515	8.5W/0.5M	4000K	700lm/0.5M					
614516	16W	3000K	1300lm					
614517	16W	4000K	1400lm					

# WallCascade

## Technical Operating & Electrical Data

IP Rating	IP65
Power	18W
Input	DC24V
CRI	85
Maximum Length	5M/Reel
Cutting Size	167MM

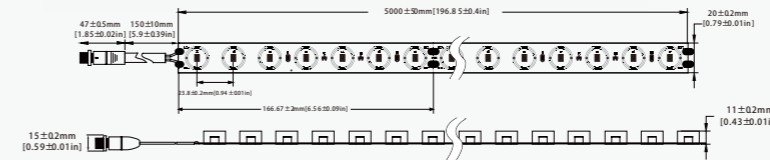

## Accessories Specifications

Connector



● 614378

T Connector



● 614379

Clip



● 614380

Profile



● 614381

Rotary support



● 614382

## Family Product List

■ Aluminum

Code No.	Power	CCT	Lumen	IP 65	CRI 85	20°*30°	DC24V	50,000h
614518	18W	3000K	2100lm					
614519	18W	4000K	2200lm					
614520	18W	3000K	2100lm					
614521	18W	4000K	2200lm					

# Freedom

## Technical Operating & Electrical Data

IP Rating	IP20
Power	14W
CRI	90
Input	DC24V
Beam Angle	140°
Cutting Unit	500MM

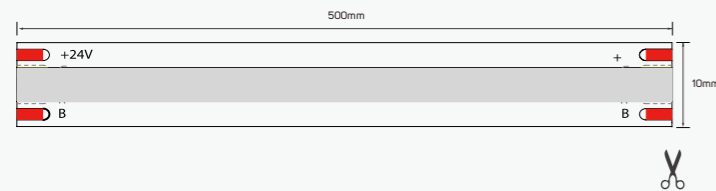

## Accessories Specifications

Remote Control

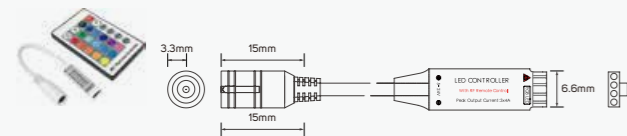

● 614036 DC24V

■ Plastic

Connector

Connector

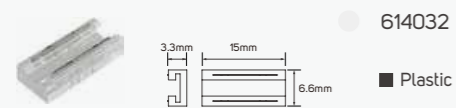

● 614032

■ Plastic

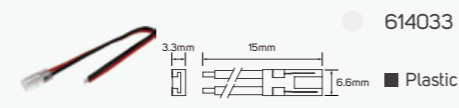

● 614033

■ Plastic

Connector

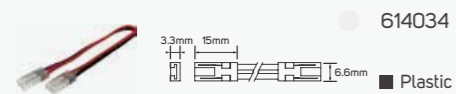

● 614034

■ Plastic

## Family Product List

■ Aluminum

Code No.	Power	CCT	Lumen
● 614035	14W	RGB	480lm R-168 G-316 B-78

■ PCB+Silicon

IP 20 CRI 90 140°  
DC24V 50,000h

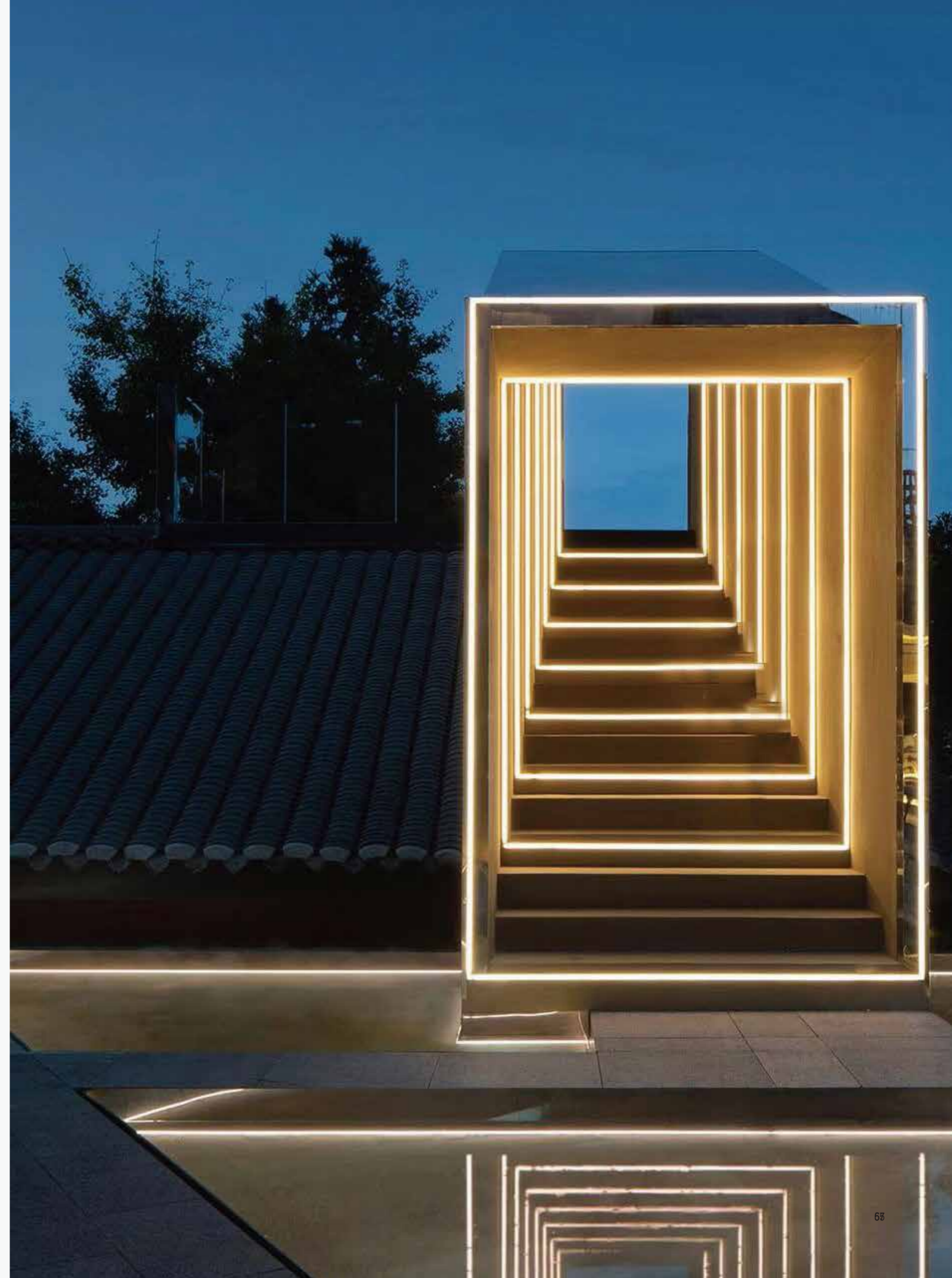

# GlowRibbon

## Technical Operating & Electrical Data

IP Rating	IP20
Power	10.5W
Input	DC24V
Beam Angle	180°
Maximum Length	5M/Reel
Cutting Unit	100MM

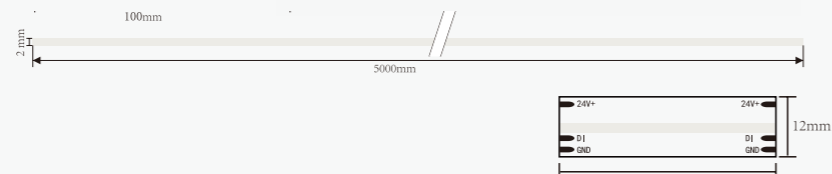

## Accessories Specifications

### Controller



### Connector



### Dimmer



## Family Product List

■ Aluminum

Code No.	Power	CCT
614276	10.5W	RGB

IP 20 DC24V 180° 50,000h

# NeonShine

## Technical Operating & Electrical Data

IP Rating	IP65
Power	2.5W
Input	DC5V
Beam Angle	130°
Maximum Length	5M/Reel
Cutting Unit	30MM

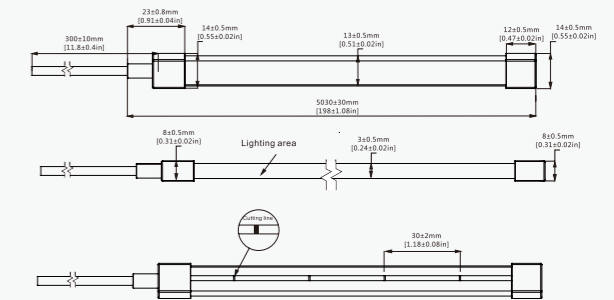

## Accessories Specifications

### Controller

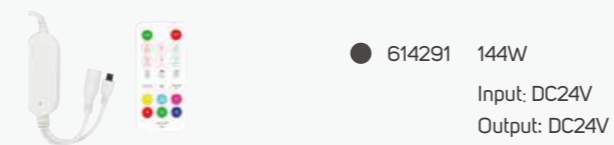

## Family Product List

■ Aluminum

Code No.	Power	CCT
614290	2.5W	RGB

IP 65 DC5V 130° 50,000h



LED Flexible Linear Light (Wall Washer)

## WallGleam

### Technical Operating & Electrical Data

IP Rating	IP65
Power	6W
Input	DC24V
CRI	90
Beam Angle	20°*55°

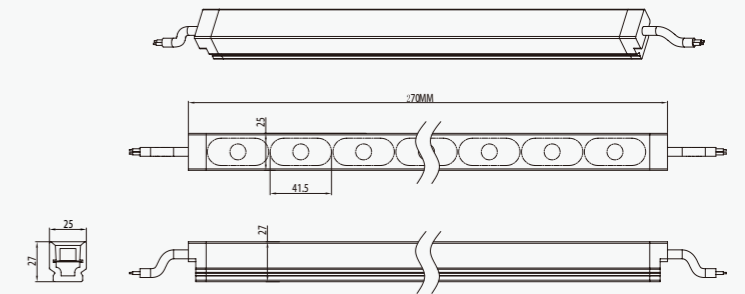
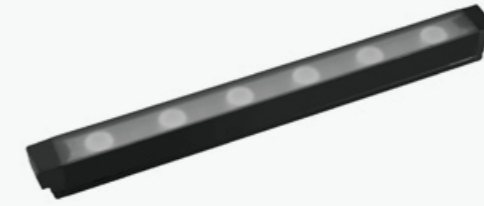

### Accessories Specifications

Clip



● 614856

Profile



● 614857

Fixing Channel



● 614858

### Family Product List

■ Aluminum

Code No.	Power	CCT	Lumen	IP 65	CRI 90	20°*55°
614848	6W/0.25M	3000K	290lm/0.25M	□ DC24V	⌚ 30,000h	
614849	6W/0.25M	4000K	310lm/0.25M			

# WallGleam

## Technical Operating & Electrical Data

IP Rating	IP65
Power	12W/0.5M
Input	DC24V
CRI	90
Beam Angle	20°*55°

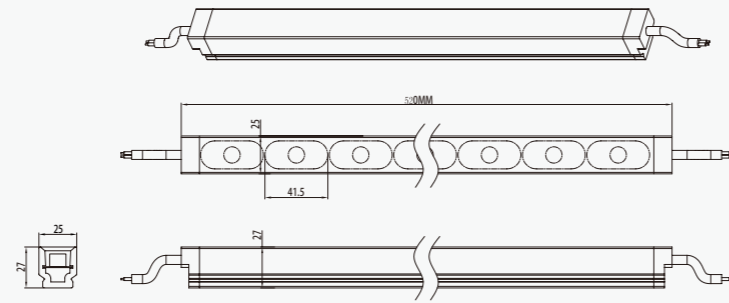
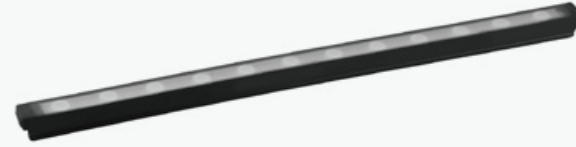

## Accessories Specifications

Clip



● 614856

Profile



● 614857

Fixing Channel



● 614858

## Family Product List

■ Aluminum

Code No.	Power	CCT	Lumen	IP 65	CRI 90	20°*55°
614850	12W/0.5M	3000K	580lm/0.5M	☑	☑	☑
614851	12W/0.5M	4000K	610lm/0.5M	☑	☑	☑

# WallGleam

## Technical Operating & Electrical Data

IP Rating	IP65
Power	18W/0.75M
Input	DC24V
CRI	90
Beam Angle	20°*55°

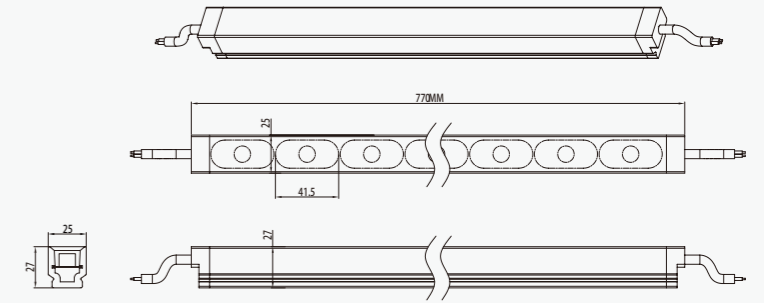

## Accessories Specifications

Clip



● 614856

Profile



● 614857

Fixing Channel



● 614858

## Family Product List

■ Aluminum

Code No.	Power	CCT	Lumen	IP 65	CRI 90	20°*55°
614852	18W/0.75M	3000K	850lm/0.75M	☑	☑	☑
614853	18W/0.75M	4000K	900lm/0.75M	☑	☑	☑

# WallGleam

## Technical Operating & Electrical Data

IP Rating	IP65
Power	24W
Input	DC24V
CRI	90
Beam Angle	20°*55°

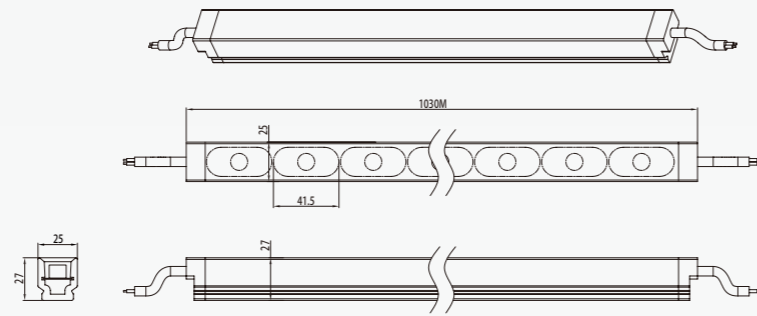

## Accessories Specifications

Clip



● 614856

Profile



● 614857

Fixing Channel



● 614858

## Family Product List

■ Aluminum

Code No.	Power	CCT	Lumen	IP 65	CRI 90	20°*55°
614854	24W/M	3000K	960lm/M	□ DC24V	⌚ 30,000h	
614855	24W/M	4000K	1040lm/M			

# WallGleam

## Technical Operating & Electrical Data

IP Rating	IP65
Power	24W
Input	DC24V
CRI	90
Beam Angle	24°

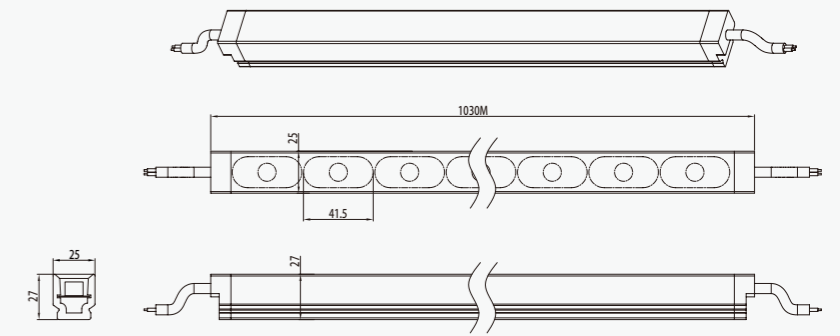

## Accessories Specifications

Clip



● 614856

Profile



● 614857

Fixing Channel



● 614858

## Family Product List

■ Aluminum

Code No.	Power	CCT	Lumen	IP 65	CRI 90	24°
614942	24W/M	3000K	1600lm/M	□ DC24V	⌚ 30,000h	

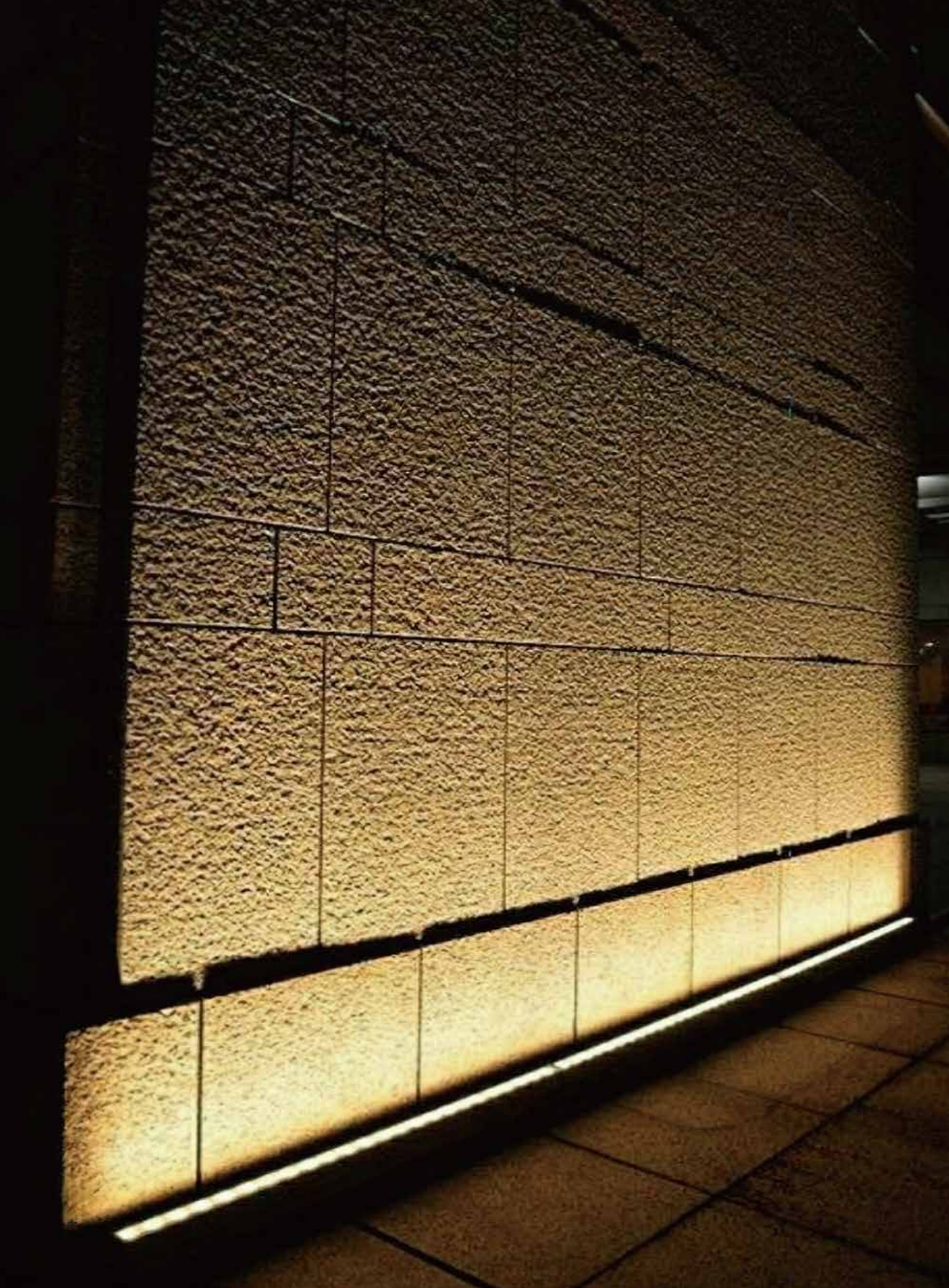

Beyond Light,  
To the last details



Beyond Light,  
To the last details

# Colourist

## Technical Operating & Electrical Data

IP Rating	IP65
Max.Power Per Reel	250W
Input	AC220-240V,50/60Hz
Cutting Unit	500mm
Beam Angle	110°

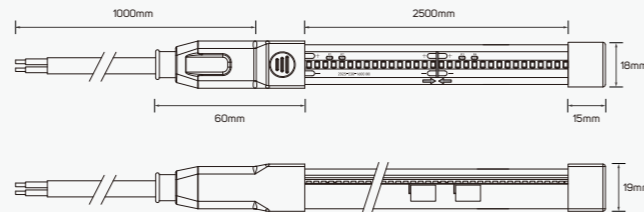

## Family Product List

■ Silicon

Code No.	Power	CCT	Lumen	
615886	10W	2200K	680lm	■ PVC anti-UV
615887	10W	2500K	710lm	IP 65 CRI 95 AC220-240V ⏱ 30,000h





LED Pendant Linear Strip Light (HV)

## WallGleam

### Technical Operating & Electrical Data

IP Rating	IP20
Power	6W
Input	AC220-240V,50/60Hz
CRI	95
Beam Angle	36°
Dimming	Dimmable
Ambient Temperature	-20°C-40°C
Switching Cycle ON/OFF	100,000

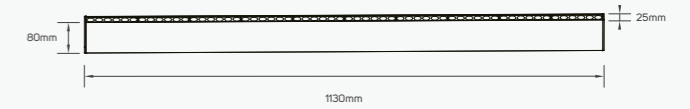

### Family Product List ■ Aluminum

Code No.	Power	CCT	Lumen	Code No.	Power	CCT	Lumen
614228	20W	3000K	2000lm	614232	30W	3000K	2850lm
614229	20W	4000K	2250lm	614233	30W	4000K	3150lm
614230	20W	3000K	2000lm	614234	30W	3000K	2850lm
614231	20W	4000K	2250lm	614235	30W	4000K	3150lm

IP 20 CRI 95 36°  
 AC220-240V 30,000h

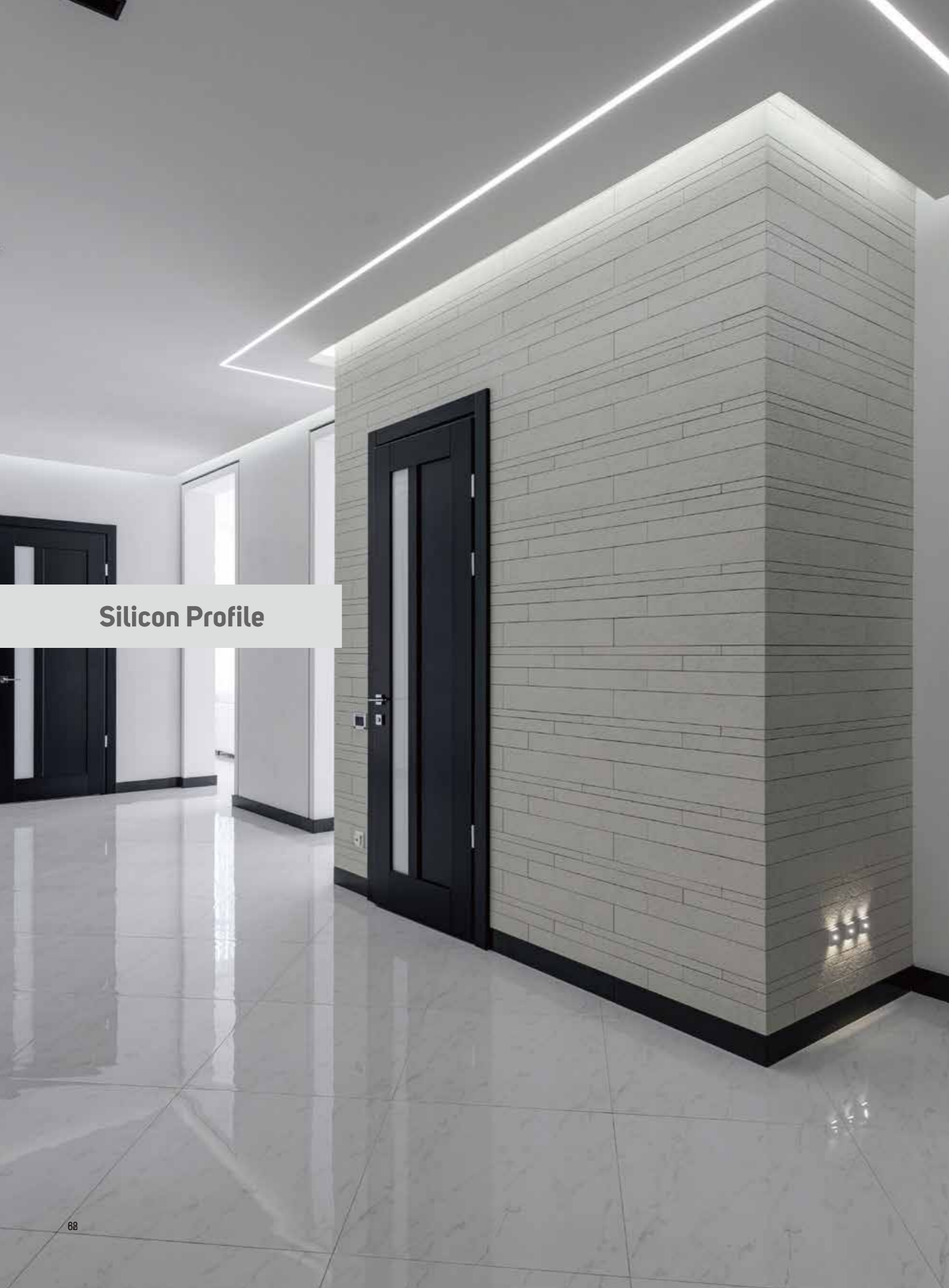

Silicon Profile

Silicon Profile

Silicon P1

Technical Operating & Electrical Data

Body Material	Silicon
IP Rating	IP65

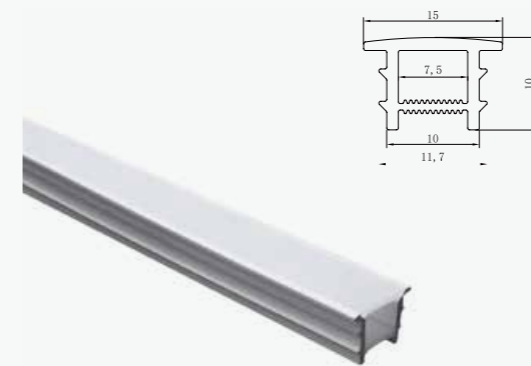

614656

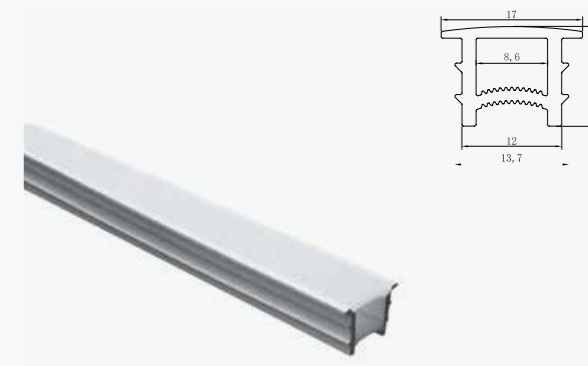

614658

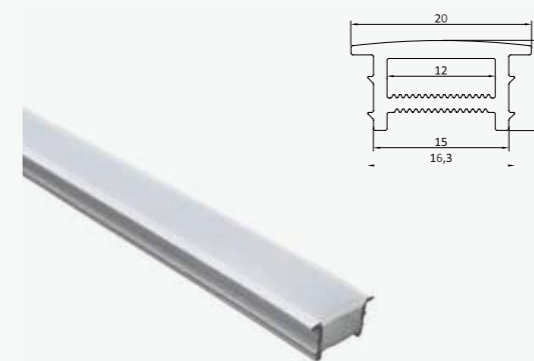

614660

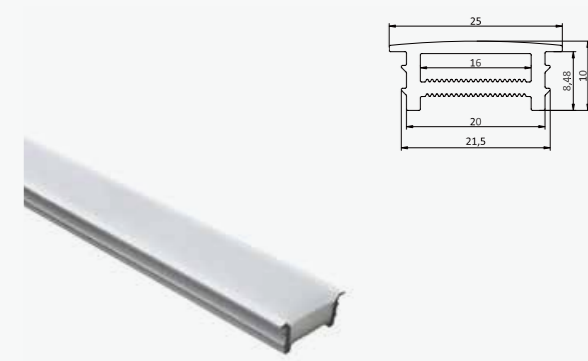

614662

# Silicon P1

## Technical Operating & Electrical Data

Body Material	Silicon
IP Rating	IP65

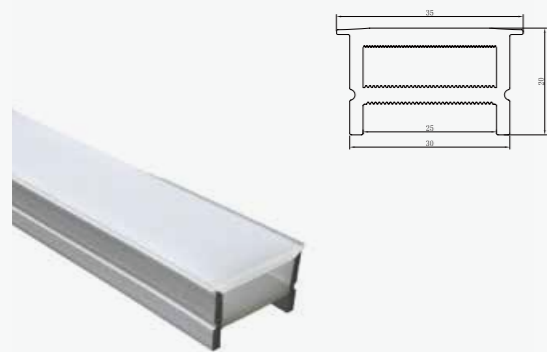

614664

## Accessories Specifications

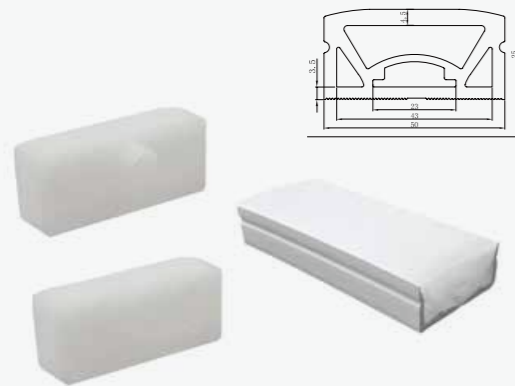

614666

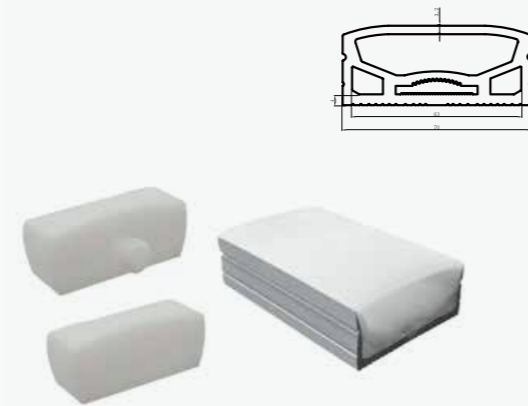

614668

# Silicon P2

## Technical Operating & Electrical Data

Body Material	Silicon
IP Rating	IP65



614671

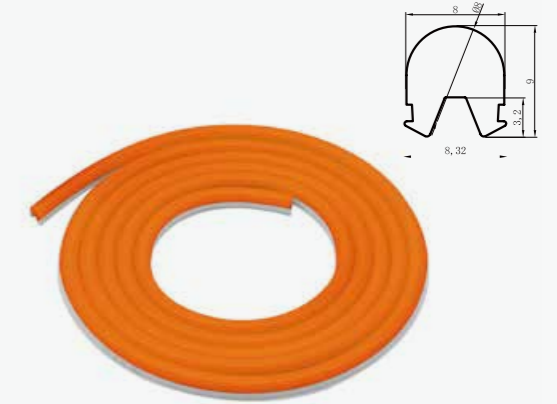

614672



614673

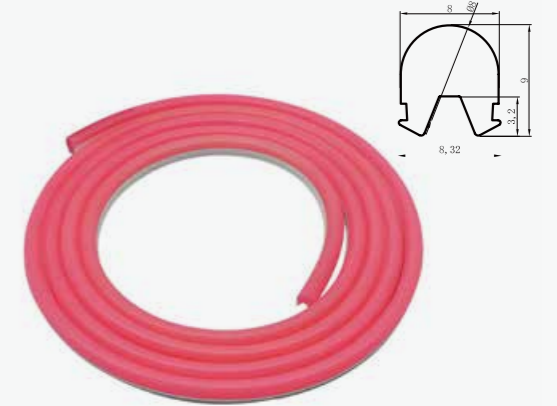

614674

## Silicon P2

### Technical Operating & Electrical Data

Body Material	Silicon
IP Rating	IP65

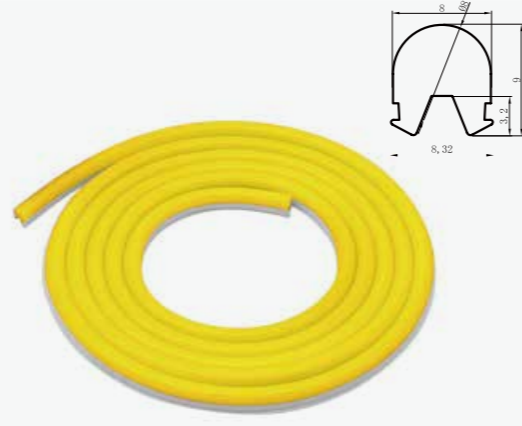

● 614675

● 614676

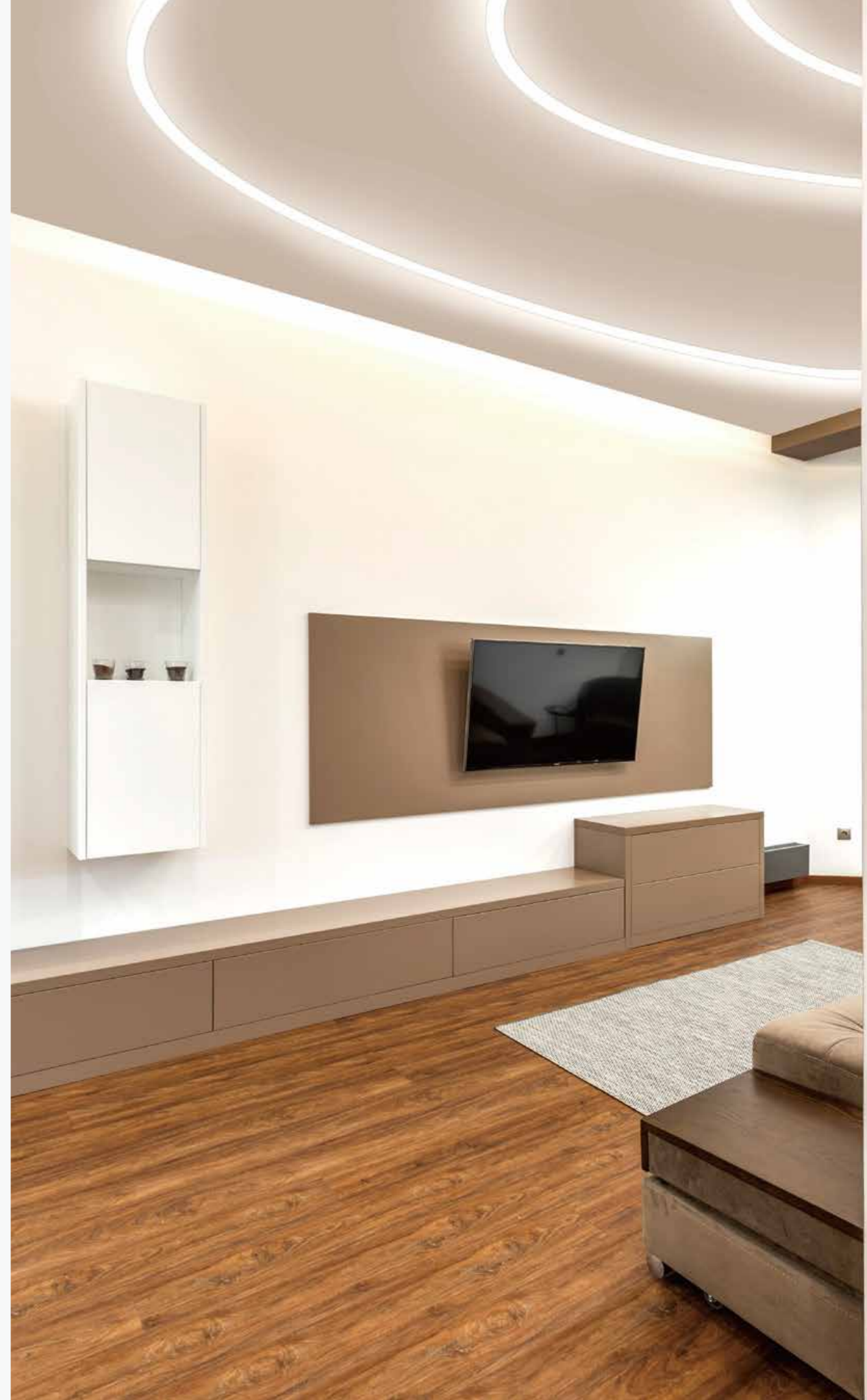

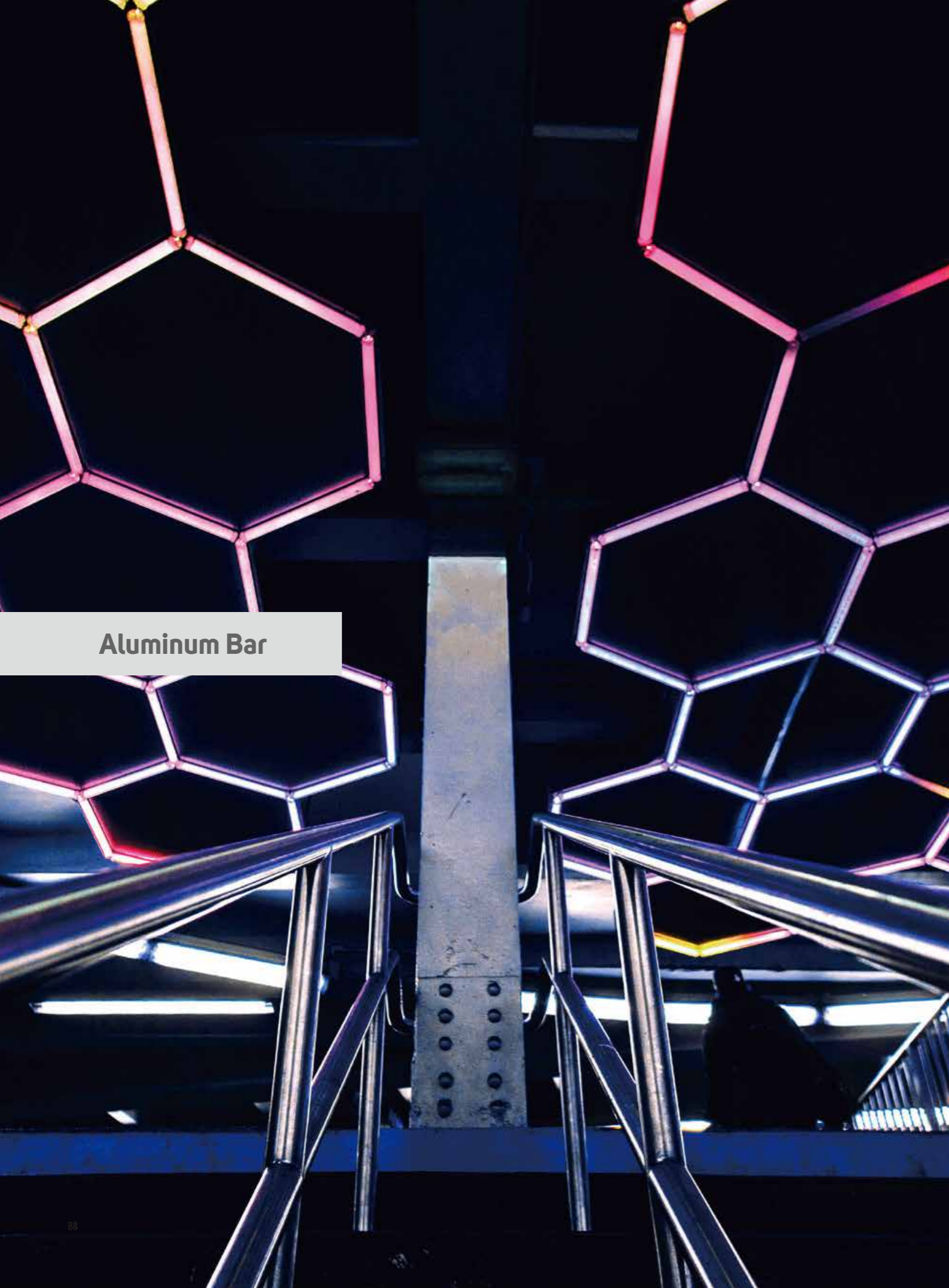

Aluminum Bar

Aluminum Bar

## lightweight

### Technical Operating & Electrical Data

Body Material	Aluminum
IP Rating	IP65

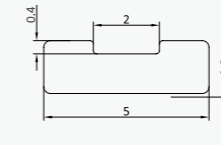

614670



Stainless Steel Fixing Channel

Stainless Steel Fixing Channel

Durable

Technical Operating & Electrical Data

Body Material                      Stainless Steel

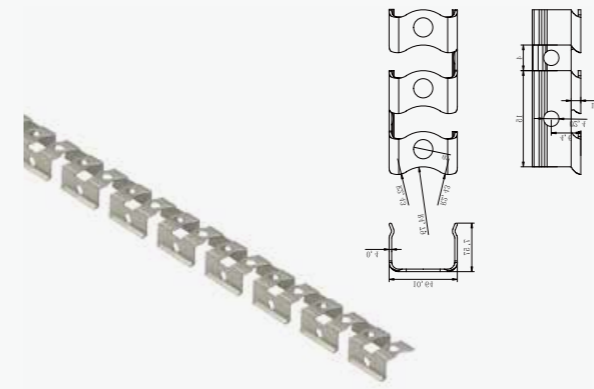

614657

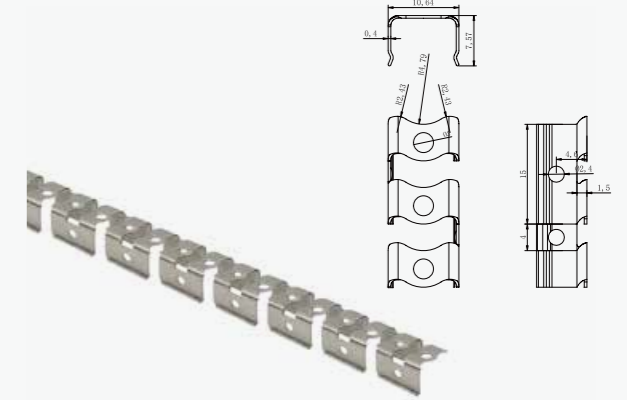

614659

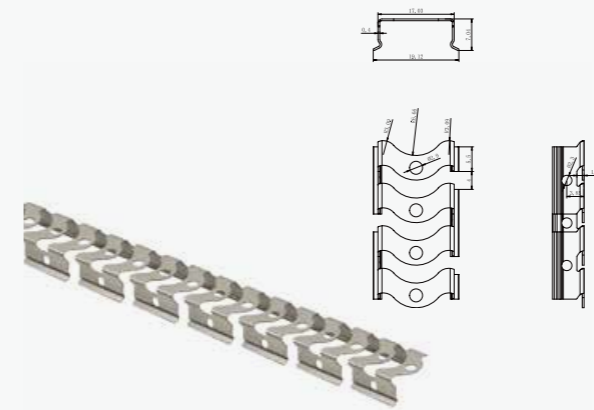

614661

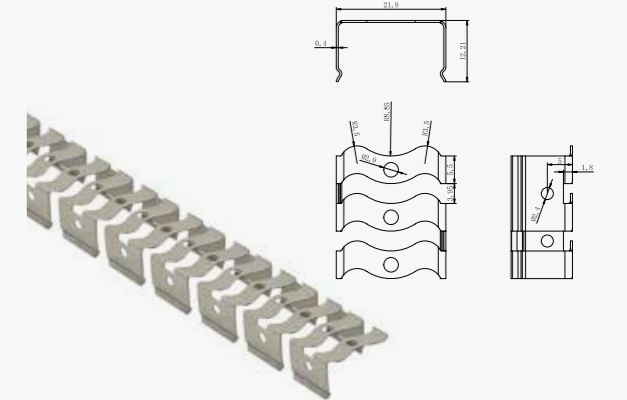

614663

# Durable

## Technical Operating & Electrical Data

Body Material      Stainless Steel

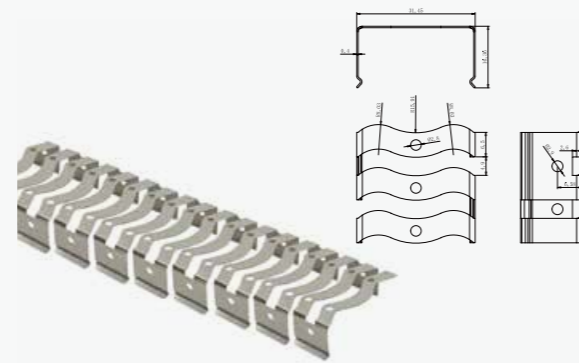
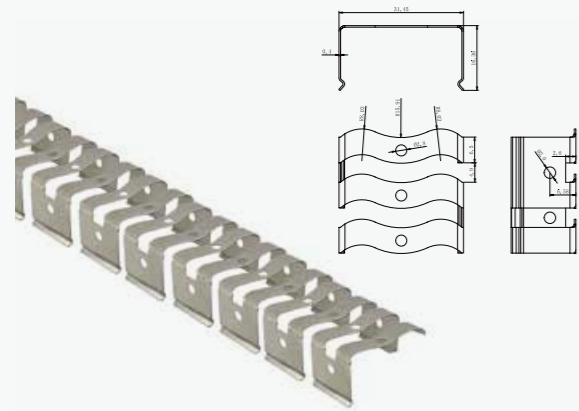

● 614665

● 614667

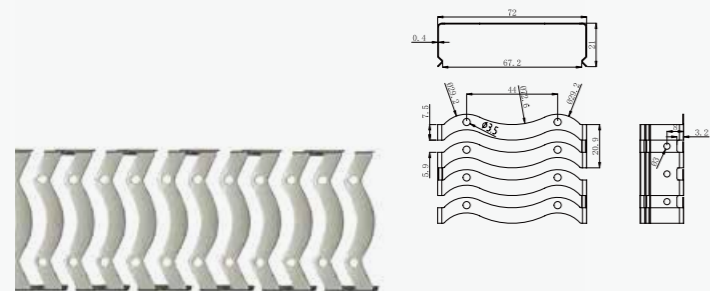

● 614669



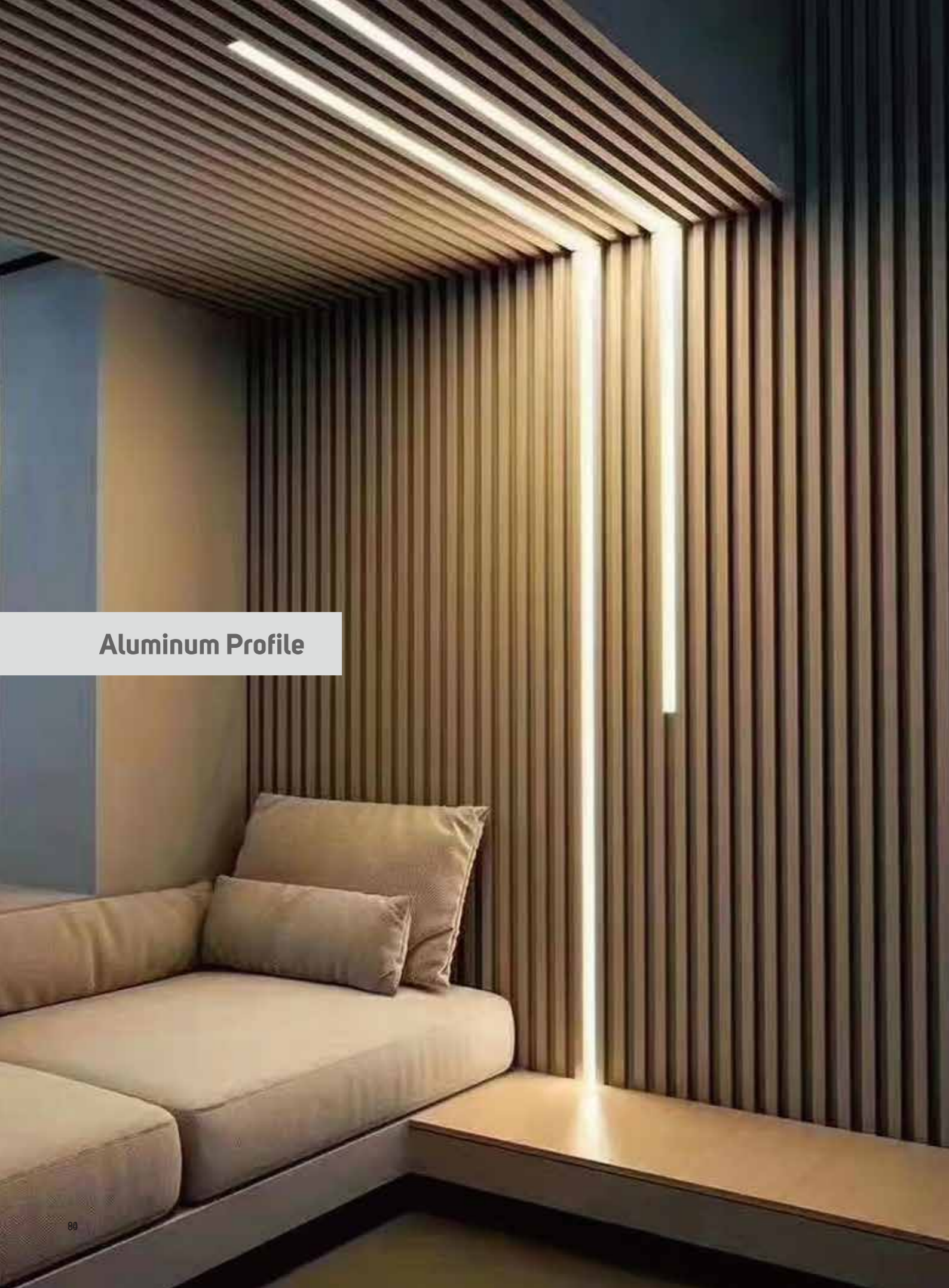

## Aluminum Profile

Aluminum Profile

## Aluminum Art

### Technical Operating & Electrical Data

Body Material	Aluminum
IP Rating	IP20

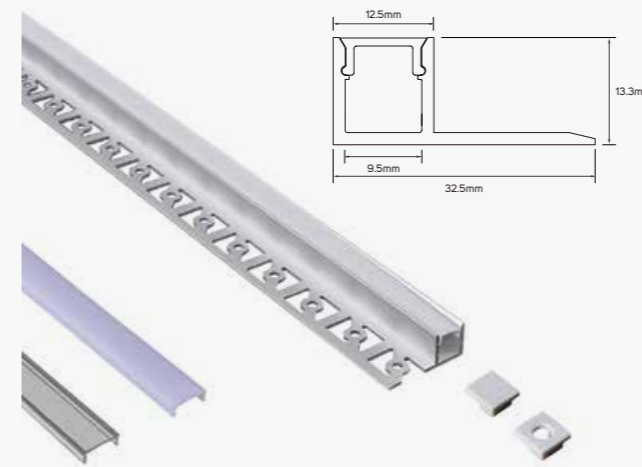

612476

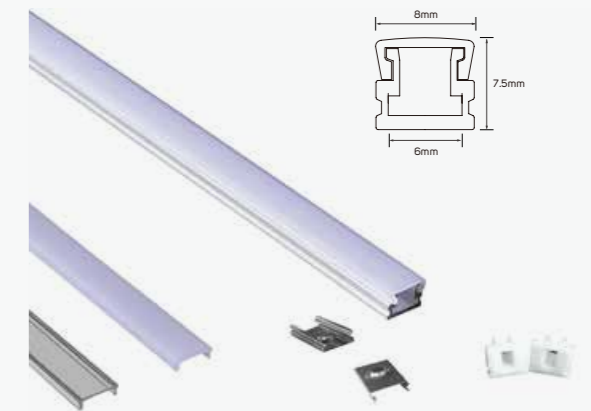

612477



612478

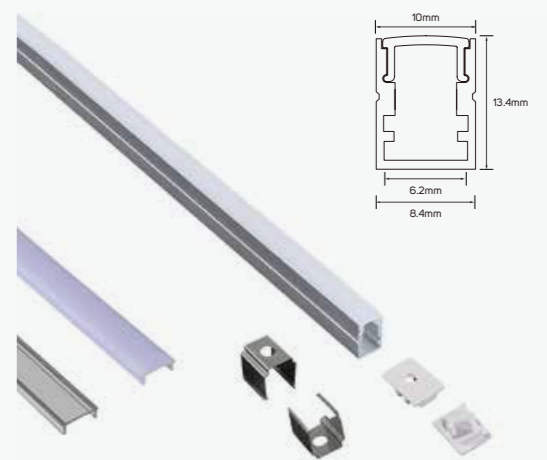

612479

# Aluminum Art

## Technical Operating & Electrical Data

Body Material Aluminum  
 IP Rating IP20

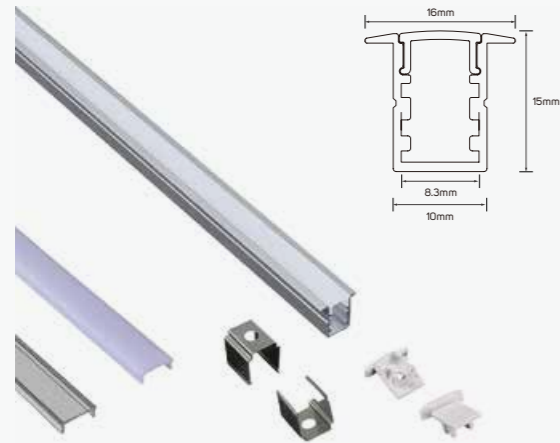

612480

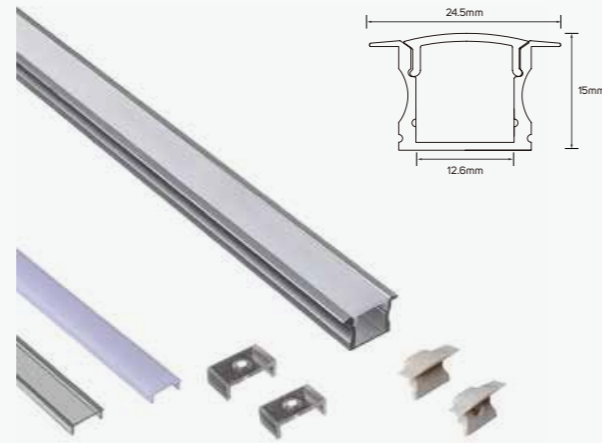

611443



611446

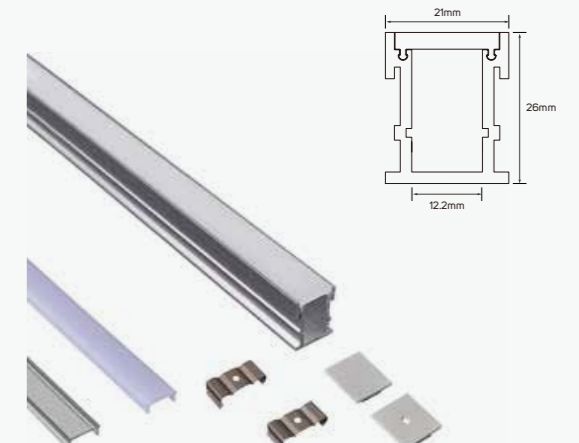

611447

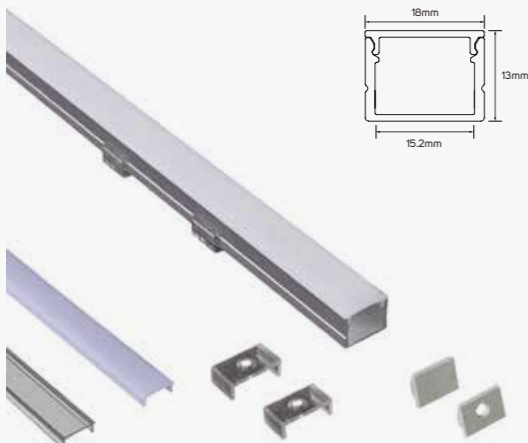

611444



611445



611448

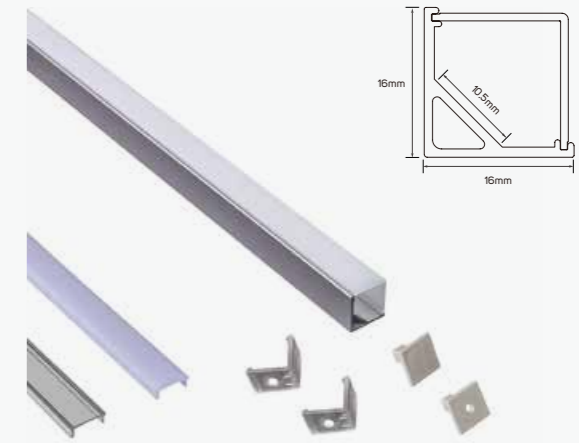

611449

# Aluminum Art

## Technical Operating & Electrical Data

Body Material Aluminum  
 IP Rating IP20

# Aluminum Art

## Technical Operating & Electrical Data

Body Material Aluminum  
IP Rating IP20

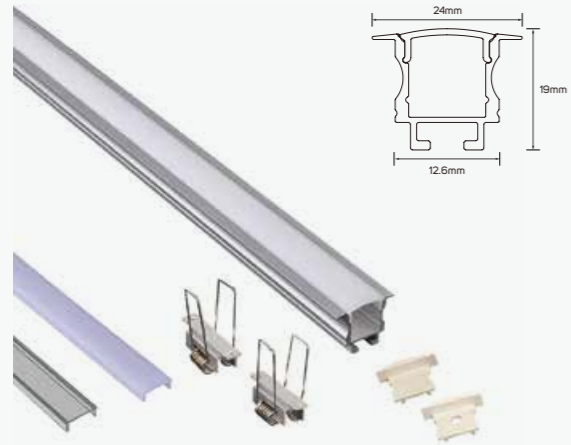

611450

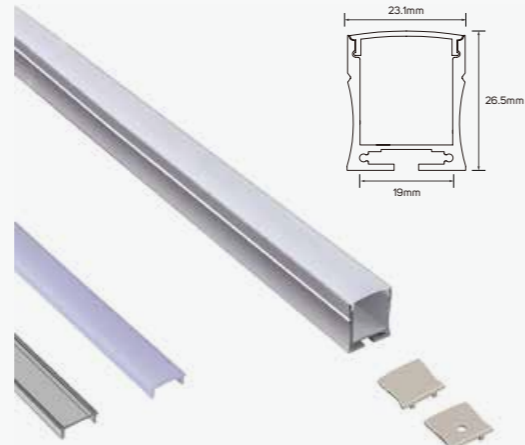

612178



615863

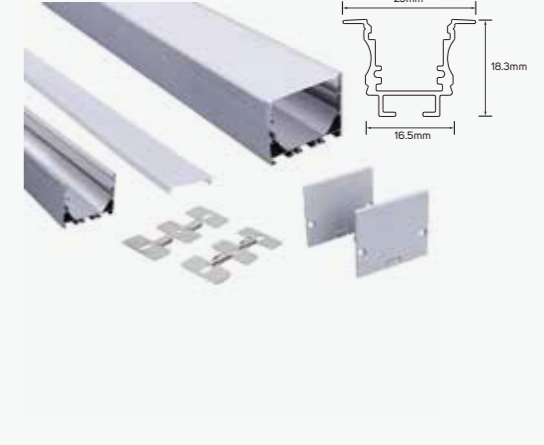

615864

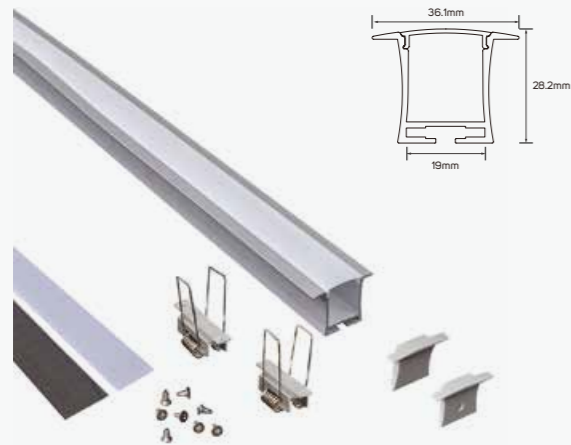

612179



615862

# Aluminum Art

## Technical Operating & Electrical Data

Body Material Aluminum  
IP Rating IP20

# Aluminum Art

## Technical Operating & Electrical Data

Body Material Aluminum  
 IP Rating IP20

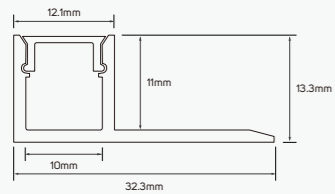
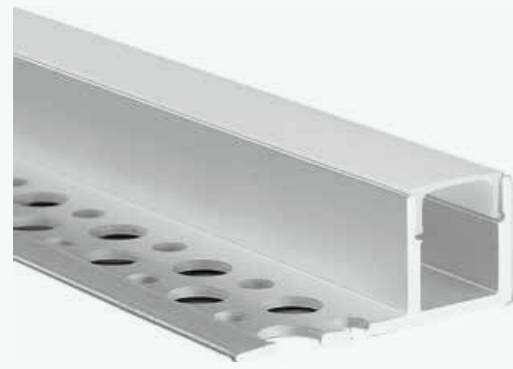

614341

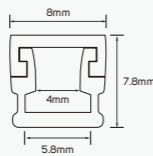
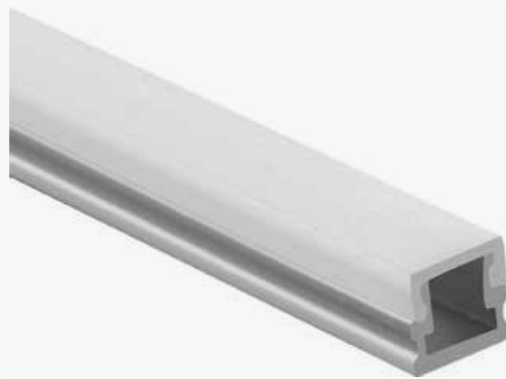

614342

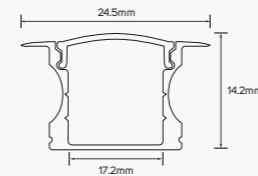

614345

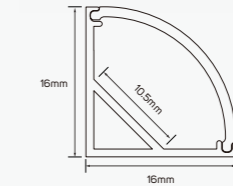

614346

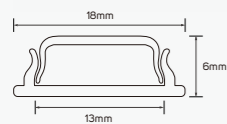

614343

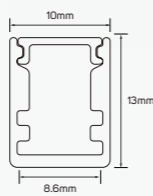
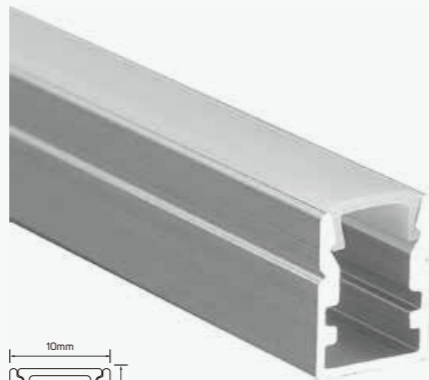

614344

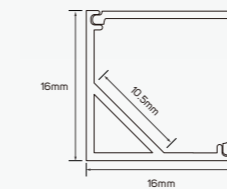
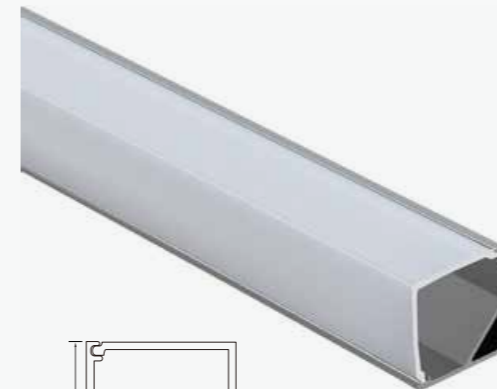

614347

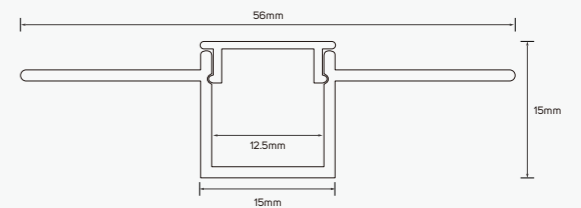

614348

# Aluminum Art

## Technical Operating & Electrical Data

Body Material Aluminum  
 IP Rating IP20

# Aluminum Art

## Technical Operating & Electrical Data

Body Material Aluminum  
 IP Rating IP20

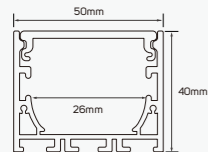

● 614349

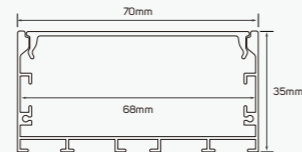

● 614350

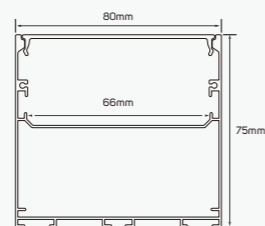

● 614351

# Aluminum Art

## Technical Operating & Electrical Data

Body Material Aluminum  
 IP Rating IP20

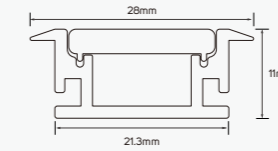

● 614325

■ Aluminum IP 20

End Cap with Hole

End Cap with Hole

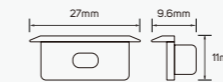

● 614326

■ PC

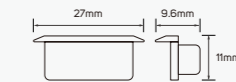

● 614327

■ PC

Metal Clips



● 614328

■ Metal

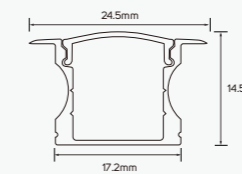

● 614329

■ Aluminum IP 20

End Cap with Hole

End Cap with Hole

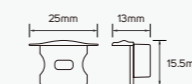

● 614330

■ PC

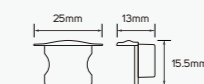

● 614331

■ PC

Metal Clips



● 614332

■ Metal

# Aluminum Art

## Technical Operating & Electrical Data

Body Material Aluminum  
 IP Rating IP20

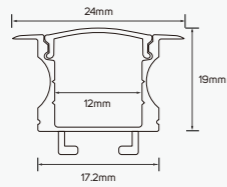

● 614333

■ Aluminum IP 20

End Cap with Hole

End Cap with Hole

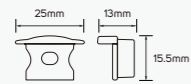

● 614334

■ PC

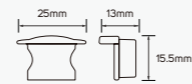

● 614335

■ PC

Metal Clips

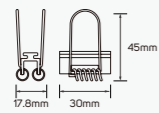

● 614336

■ Metal

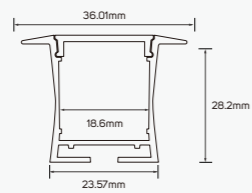

● 614337

■ Aluminum IP 20

End Cap with Hole

End Cap with Hole

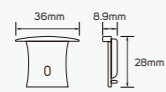

● 614338

■ PC

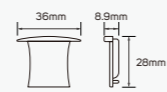

● 614339

■ PC

Metal Clips



● 614340

■ Metal



# Aluminum Art

## Technical Operating & Electrical Data

Body Material Aluminum  
 IP Rating IP20



614362

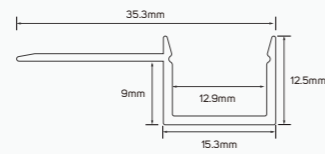

Aluminum IP 20

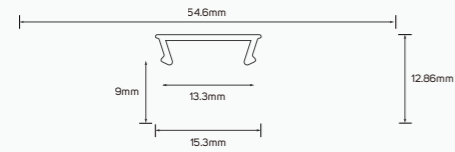

614363 Aluminum IP 20

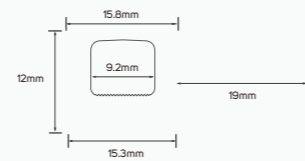

614580 Silicon IP 20

## Accessories Specifications

611443D IP 20  
 615863D IP 20  
 Plastic

611444D IP 20  
 Plastic

611450D IP 20  
 615864D IP 20  
 Plastic

611480D IP 20  
 Plastic

614341D IP 20  
 Plastic

614343D IP 20  
 Plastic

614349D IP 20  
 Plastic

# Aluminum Art

## Technical Operating & Electrical Data

Body Material                      Aluminum  
IP Rating                              IP20

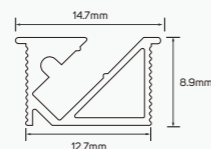

● 615693

■ Aluminum      IP 20



● 615694

■ Plastic      IP 20



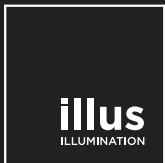

Contact Us

[global@illuslighting.com](mailto:global@illuslighting.com)

[www.illuslighting.com](http://www.illuslighting.com)

Find us in KSA, UAE, Oman, Kuwait, Qatar, Egypt, Spain, Bahrain, China.