

Indoor Lighting

2026 Catalogue

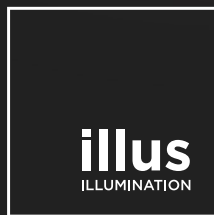

BEYOND LIGHT..
TO THE LAST DETAILS!

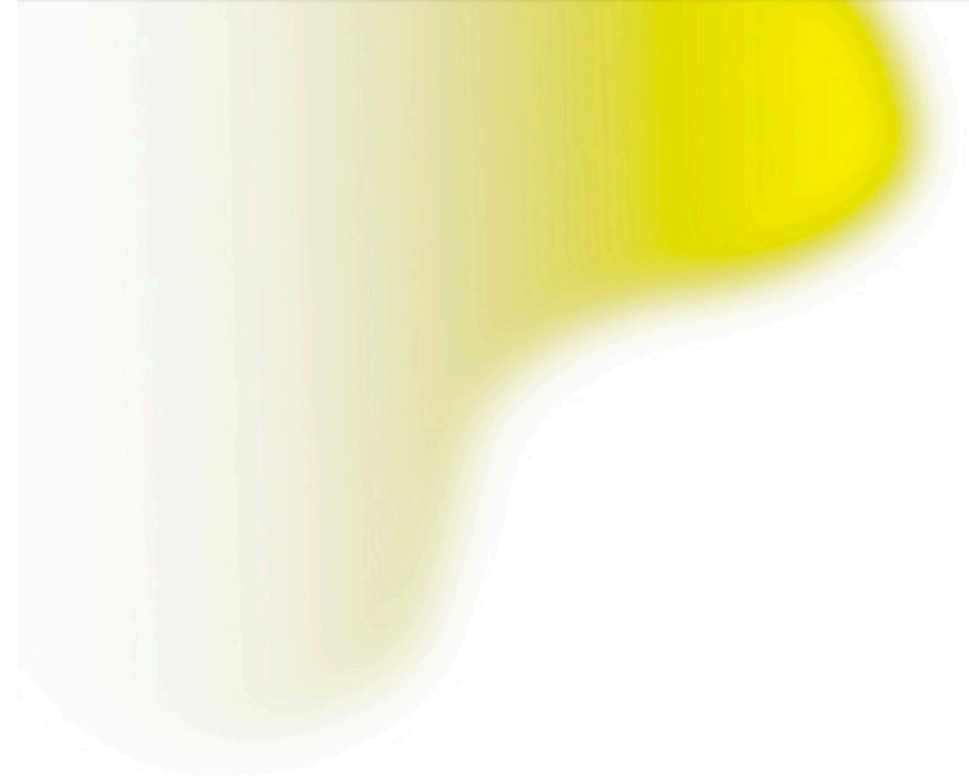
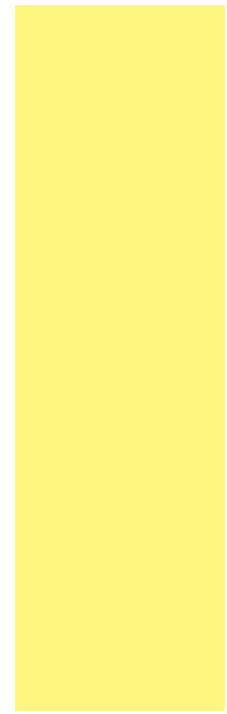

We strive to be
the leader in the industry
and the world's most
respected lighting solution
provider.



ILLUS Lighting

ILLUS dedicates itself to provide human oriented architectural lighting solution and products for indoor and outdoor applications. A truly innovative company, ILLUS has always been at the forefront of professional office lighting since inception. Since then ILLUS continues developing innovative, custom lighting solutions that meet extremely exacting requirements in terms of ergonomics, economic efficiency and environmental compatibility and also deliver aesthetic added value to our customers. Our customers will always find that our solutions reflect the requirements satisfying a broad range of customer needs for every lighting application ILLUS is a brand that helps revealing the beauty around you where it constitutes of products and solutions designed with care and attention to detail giving professional quality products.

Our goal has always been to offer our customers a first-class product backed by unparalleled service, focused on solving our client's illumination challenges.

Our Vision

In ILLUS every detail created with enthusiasm constantly evolving technology to simplify the life of people. We consistently innovate and devote to decrease power consumption to ease the burden of earth. Light is essential for people's life quality and well-being, we care for every situation people need artificial light whenever light serves. ILLUS lighting is beyond light, to the last details.

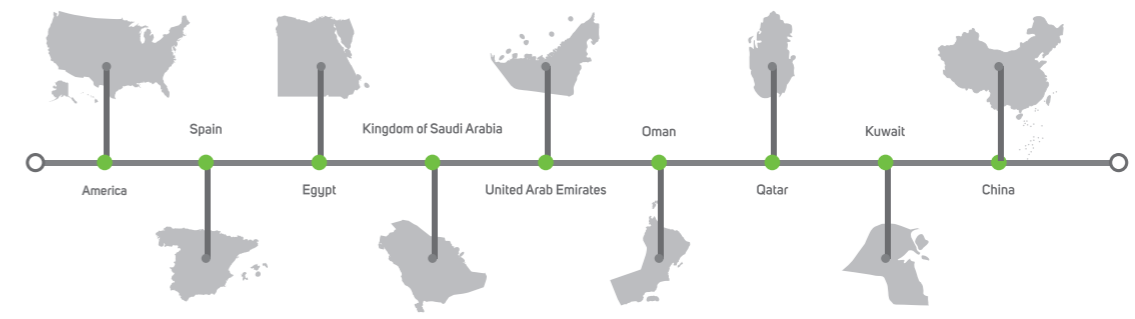

Where to find us

Kingdom of Saudi Arabia-Head Office

📍 3533 Al Kharj Rd, Al Aziziyah, Riyadh 14511
<https://maps.app.goo.gl/TRgDmL4efaDRzWWL8>

China – illus

📍 Star Alliance, No.68 Zhongxing Avenue, Guzhen, Zhongshan,Guangdong, China
<https://maps.app.goo.gl/cJJefWvYRyfzAQjq8>

Spain – illus

📍 46970 Alaquàs, Valencia, Spain
<https://goo.gl/maps/C5DejH52sP17L2Nv9>

UAE – Build Station

📍 75 6th St - Al Quoz - Dubai - United Arab Emirates
<https://goo.gl/maps/LCTSSYSqEB2mcAbA8>

Kingdom of Bahrain

📍 7J3Q+R36, Arad, Bahrain
<https://maps.app.goo.gl/e2wceYwDusnepts7>

Qatar – Build Station

📍 Zone 43, Street 340, Salwa Rd, Doha, Qatar
<https://maps.app.goo.gl/hQY8PbFDPbXKYiqJ6>

Oman – Build Station

📍 18 November Street 411 Muscat, Al Aziba, 130, Oman
<https://goo.gl/maps/6LJLBVdhiVPvUE1w7>

Kuwait –Lighting Stores

📍 No 4, Opposite the city center entrance, 142 8 St, Shuwaikh Industrial, Kuwait
Lighting Stores - Google Maps

Egypt -illus

📍 13 El Obour Bldgs. Salah Salem – Masr El-Gedida - Cairo
30° 04'40.0"N 31° 18'36.7"E - Google Maps

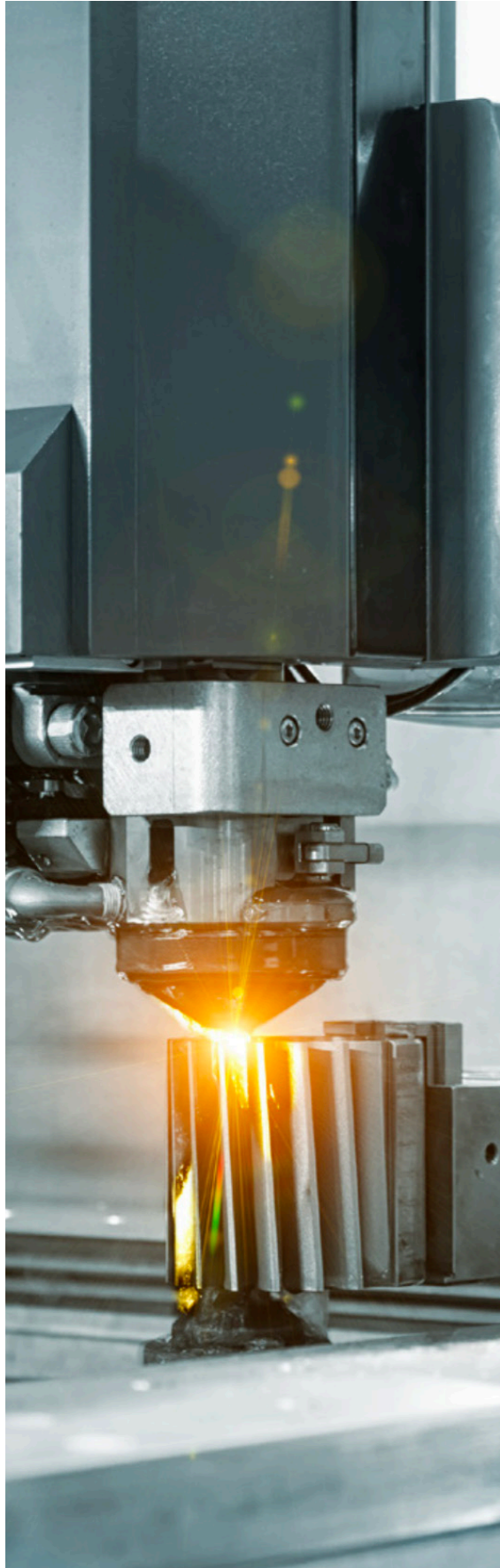

R&D and Manufacturing

Manufacturing

ILLUS has two directly-operated production bases in Yangzhou covering an area of 25,000 square meters and 300 staffs. The production bases contain over 30 hi-speed automatic encapsulation lines, 15 automatic SMD and applied welding lines, 5 automatic extrusion lines and 6 automatic luminaire production lines, characterizing a complete production process for LED strip inclusive of LED encapsulation, hi-speed SMT, automatic welding and full series of water resistance with average monthly production capacity of LED strips reaching up to 1.5 million meters. Besides, ILLUS modernized manufacturing factory to achieve a complete production process for linear luminaire inclusive of precision machining, automatic assembly, color spraying and free customization with average monthly production capacity reaching up to 120,000 strips in order to assure customers of high-quality, super cost-effective products and rapid delivery.

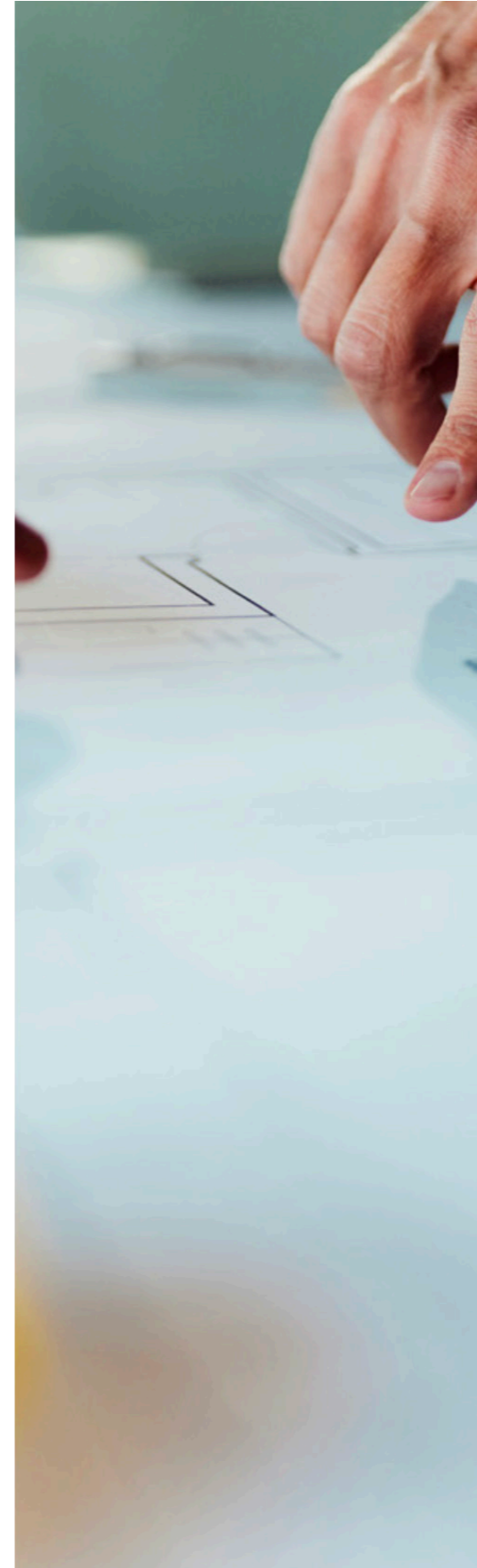

R&D

ILLUS has established a R&D expert team composed of over 50 core technicians, a majority of which graduated from top-rated universities and are proficient in such fields as optics, technique, material science, electrics, thermal physics, intelligent control and industrial design with more than 10years R&D experience and technical know-how in linear lighting.

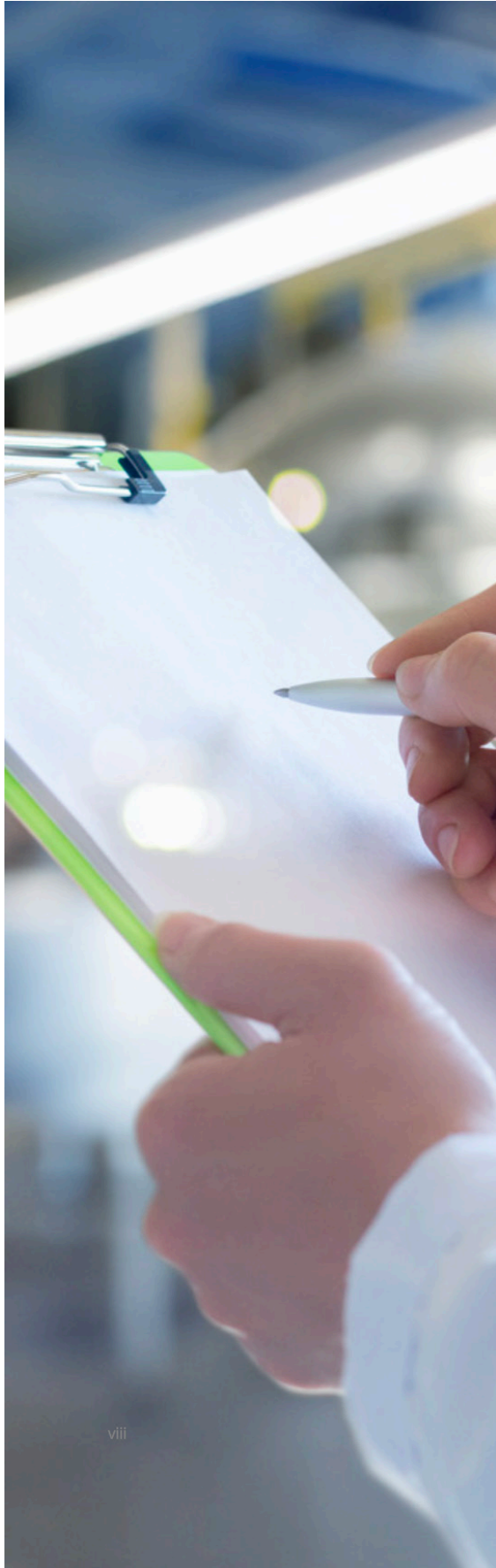

Laboratory & Inspection

Laboratory of ILLUS, covering an area of 460 square meters, was outfitted with 48 sets of equipment which was distributed as per safety zone, EMC zone, photoelectric zone, IP water resistance zone, aging zone and product reliability zone. Inspection covers products inclusive of LED strip, neon strip, linear luminaire, power supply and related accessories, with inspection standard ranging from safety, EMC, performance to product reliability. Testing reports can be tracked all the way from product design evaluation period to type approval period to guarantee quality of products.



Patent

ILLUS strives to R&D in product and technology. So far, it has gained 3 invention patents and nearly 100 utility model patents and appearance patents.

Contents

LED Magnetic Series

- Slim LED Magnetic Track Spot Light
- LED Magnetic Track Linear Light (Black Version)
- LED Flood Track Luminaire
- LED Adjustable Magnetic Track Linear Light (Black Version)
- LED Adjustable Flood Track Luminaire
- LED Magnetic Track Spot Light (Black Version)
- LED Magnetic Track Pendant Light (Black Version)
- LED Magnetic Track Linear Light (White Version)
- LED Adjustable Magnetic Track Linear Light (White Version)
- LED Magnetic Track Spot Light (White Version)
- LED Magnetic Lights

LED Recessed & Surface Mounted Ceiling Luminaire

- LED Flat Luminaire Series
- IP65 Downlight
- SMD
- SMD CCT
- Mini Downlight
- LED Recessed Ceiling Luminaire

LED Track & Track Rail Accessories

- Track Light Luminaire
- LED Track Mounted Luminaire
- LED Recessed Linear Light Luminaire
- LED Recessed Linear Light Luminaire (Trimless)
- LED Recessed Linear Light Luminaire (Wall Washer)
- LED Recessed Spot Light Luminaire
- LED Recessed Linear Luminaire
- LED Recessed Linear Luminaire-Corner
- LED Pendant Linear Light Luminaire
- LED Pendant Linear Luminaire-Corner
- Track

LED Lamp

- LED Module Luminaire (MR11)
- LED Module Luminaire (MR16)
- LED AR111
- LED 50 Module (GU10)
- LED 35 Module (MR11)
- LED G9 Lamp
- LED GU10 Lamp
- LED Smart Lamp
- LED Non-Directional Lamp
- LED Filament Lamp
- LED Filament Lamp E27
- LED Filament Lamp E14
- LED Filament Lamp (PIR Sensor)
- LED Filament Lamp (Microwave Sensor)
- LED T8 Glass Tube Light

Frames/Housing

- Frame
- Gypsum Frame

Accessories

- Indoor Connector
- Emergency Back Up Battery

BEYOND LIGHT..
TO THE LAST DETAILS!

Indoor Lighting

- LED Magnetic Series
- LED Recessed & Surface Mounted Ceiling
- LED Track & Track Rail Accessories
- LED Lamp
- Accessories
- Frames/Housing

LED Magnetic Series

- Slim LED Magnetic Track Spot Light
- LED Magnetic Track Linear Light (Black Version)
- LED Flood Track Luminaire
- LED Adjustable Magnetic Track Linear Light (Black Version)
- LED Adjustable Flood Track Luminaire
- LED Magnetic Track Spot Light (Black Version)
- LED Magnetic Track Pendant Light (Black Version)
- LED Magnetic Track Linear Light (White Version)
- LED Adjustable Magnetic Track Linear Light (White Version)
- LED Magnetic Track Spot Light (White Version)
- LED Magnetic Lights



Slim Led Magnetic Track Spot Light

PRODUCT INFORMATION

- Modern looking, neat luminaire offering comfortable, good quality lighting and can also work as a design element.
- Ideal lighting in the non-working areas of professional spaces such as offices, educational institutes, and also the welcoming areas and entrances of retail spaces.
- ILLUS LED MAGNETIC TRACK SPOT LIGHT gives the customer the flexibility to choose between 8 models based on their specific need with lumen package from 470lm to 1850lm.

BENEFITS

- Clean and uniform light.
- Multiple application use.
- Easy to install and maintain.

FEATURES

- High CRI>95.
- Efficacy up to 86lm/W.
- Long lifespan 30,000H.
- Operating voltage DC48V.
- Non-Dimmable.

Slim Led Magnetic Track Spot Light

Radian

Technical Operating & Electrical Data

Operating Voltage	DC48V
IP Rating	IP20
Body Material	Aluminum
Rated CRI	95
Body Color	Black
Ambient Temperature	-20°C-45°C
Dimming	Non-Dimmable
Lifespan	30000H
Switching Cycle	100000x on/off
Warranty Period	36 Months

Areas of Application

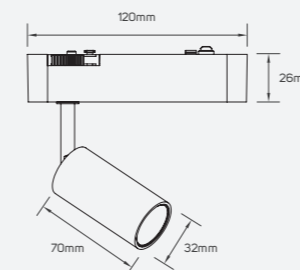
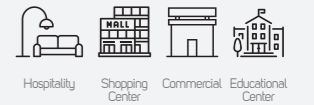

615128 - 615129

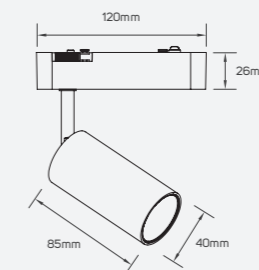

615132 - 615133

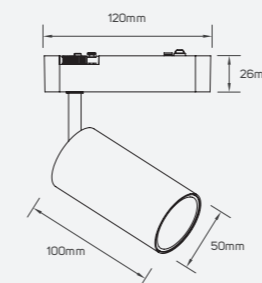

615136 - 615137

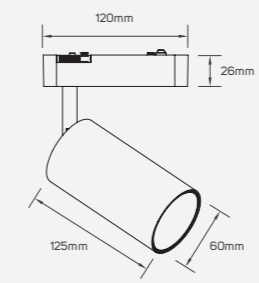

615140 - 615141

Family Product List

Code No.	Model No.	Power	Lumen	Efficacy	CCT	Beam Angle	Saving Energy	Current	Equivalent
● 615128	ILS6.5WMGFSL930WW01	6.5W	470lm	72.31lm/W	3000K	24°	90%	130mA	66W
● 615129	ILS6.5WMGFSL940NW01	6.5W	500lm	76.92lm/W	4000K	24°	91%	130mA	70W
● 615132	ILS11.5WMGFSL930WW01	11.5W	940lm	81.74lm/W	3000K	24°	91%	240mA	128W
● 615133	ILS11.5WMGFSL940NW01	11.5W	990lm	86.09lm/W	4000K	24°	91%	240mA	134W
● 615136	ILS16WMGFSL930WW01	16W	1200lm	75lm/W	3000K	24°	90%	330mA	162W
● 615137	ILS16WMGFSL940NW01	16W	1270lm	79.38lm/W	4000K	24°	91%	330mA	171W
● 615140	ILS23WMGFSL930WW01	23W	1750lm	76.09lm/W	3000K	24°	90%	470mA	233W
● 615141	ILS23WMGFSL940NW01	23W	1850lm	80.43lm/W	4000K	24°	91%	470mA	246W



Slim Led Magnetic Track Spot Light

Flare

Areas of Application



Technical Operating & Electrical Data

Operating Voltage	DC48V
IP Rating	IP20
Body Material	Aluminum
Rated CRI	95
Body Color	Black
Ambient Temperature	-20°C~45°C
Dimming	Non-Dimmable
Lifespan	30000H
Switching Cycle	100000x on/off
Warranty Period	36 Months

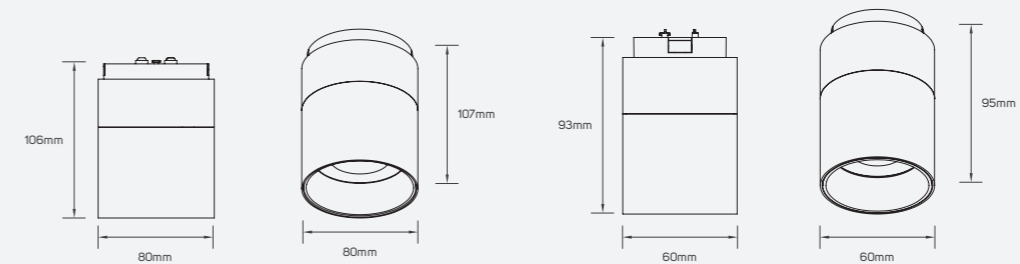

615144 - 615145

615148 - 615149

Family Product List

Code No.	Model No.	Power	Lumen	Efficacy	CCT	Beam Angle	Saving Energy	Current	Equivalent
● 615144	ILS23WMGFSL930WW03	23W	1950lm	84.78lm/W	3000K	24°	91%	470mA	259W
● 615145	ILS23WMGFSL940NW03	23W	2050lm	89.13lm/W	4000K	24°	92%	470mA	272W
● 615148	ILS12WMGFSL930WW03	12W	1000lm	83.33lm/W	3000K	24°	91%	250mA	135W
● 615149	ILS12WMGFSL940NW03	12W	1050lm	87.50lm/W	4000K	24°	92%	250mA	142W



Slim Led Magnetic Track Flood Light

PRODUCT INFORMATION

- Modern looking, neat luminaire offering comfortable, good quality lighting and can also work as a design element.
- Ideal lighting in the non-working areas of professional spaces such as offices, educational institutes, and also the welcoming areas and entrances of retail spaces.
- ILLUS SLIM LED MAGNETIC TRACK FLOOD Light gives the customer the flexibility to choose between 6 models based on their specific need with lumen package from 810lm to 2250lm.

BENEFITS

- Clean and uniform light.
- Multiple application use.
- Easy to install and maintain.

FEATURES

- High CRI>95.
- Efficacy up to 77 lm/W.
- Long lifespan 30,000H.
- Operating voltage DC48V.
- Non-Dimmable.

Slim Led Magnetic Track Flood Light

Shine

Technical Operating & Electrical Data

Operating Voltage	DC48V
IP Rating	IP20
Body Material	Aluminum
Rated CRI	95
Body Color	Black
Beam Angle	110°
Dimming	Non-Dimmable
Lifespan	30000H
Switching Cycle	100000x on/off
Warranty Period	36 Months

Areas of Application

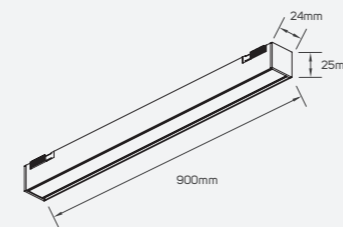
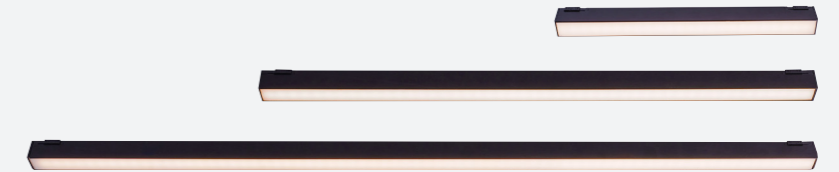
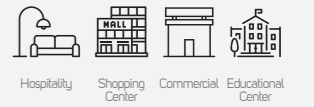

615152 - 615153

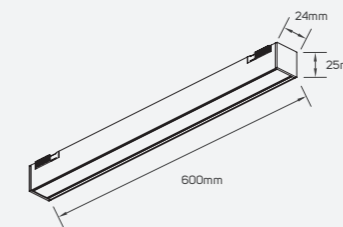

615156 - 615157

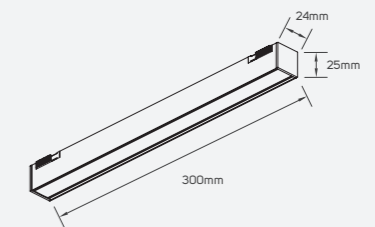

615160 - 615161

Family Product List

Code No.	Model No.	Power	Lumen	Efficacy	CCT	Saving Energy	Current	Equivalent
● 615152	ILS30WSMLF930WW01	30W	2200lm	73.33lm/W	3000K	78%	620mA	134W
● 615153	ILS30WSMLF940NW01	30W	2250lm	75lm/W	4000K	79%	620mA	142W
● 615156	ILS24WSMLF930WW01	24W	1750lm	72.92lm/W	3000K	79%	500mA	112W
● 615157	ILS24WSMLF940NW01	24W	1850lm	77.08lm/W	4000K	80%	500mA	118W
● 615160	ILS12WSMLF930WW01	12W	810lm	67.50lm/W	3000K	80%	250mA	60W
● 615161	ILS12WSMLF940NW01	12W	850lm	70.83lm/W	4000K	81%	250mA	63W



Slim Led Magnetic Track Round Light

Pure

Technical Operating & Electrical Data

Operating Voltage	DC48V
IP Rating	IP20
Body Material	Aluminum
Rated CRI	95
Body Color	Black
Beam Angle	110°
Current	370mA
Dimming	Non-Dimmable
Lifespan	30000H
Switching Cycle	100000x on/off
Warranty Period	36 Months

Areas of Application

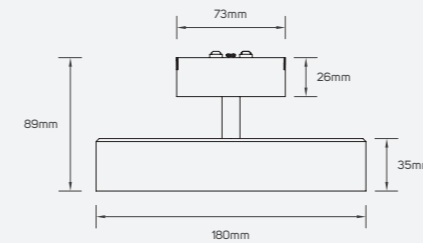
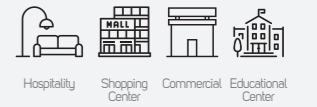

Slim Led Magnetic Track Round Light

PRODUCT INFORMATION

- Modern looking, neat luminaire offering comfortable, good quality lighting and can also work as a design element.
- Ideal lighting in the non-working areas of professional spaces such as offices, educational institutes, and also the welcoming areas and entrances of retail spaces.
- ILLUS SLIM LED MAGNETIC TRACK ROUND LIGHT gives the customer the flexibility to choose between 2 models based on their specific need with lumen package from 1300lm to 1400lm.

BENEFITS

- Clean and uniform light.
- Multiple application use.
- Easy to install and maintain.

FEATURES

- High CRI>95.
- Efficacy up to 78lm/w.
- Long lifespan 30,000H.
- Operating voltage DC48V.
- Non-Dimmable.

Family Product List

Code No.	Model No.	Power	Lumen	Efficacy	CCT	Saving Energy	Equivalent
● 615164	ILS18WSMDL930WW01	18W	1300lm	72.22lm/W	3000K	80%	88W
● 615165	ILS18WSMDL940NW01	18W	1400lm	77.78lm/W	4000K	81%	94W



Slim Led Magnetic Track Pendant Light

PRODUCT INFORMATION

- Modern looking, neat luminaire offering comfortable, good quality lighting and can also work as a design element.
- Ideal lighting in the non-working areas of professional spaces such as offices, educational institutes, and also the welcoming areas and entrances of retail spaces.
- ILLUS SLIM LED MAGNETIC TRACK PENDANT LIGHT gives the customer the flexibility to choose between 4 models based on their specific need with lumen package from 380lm to 410lm.

BENEFITS

- Clean and uniform light.
- Multiple application use.
- Easy to install and maintain.

FEATURES

- High CRI>95.
- Efficacy up to 82lm/w.
- Long lifespan 30,000H.
- Operating voltage DC48V.
- Non-Dimmable.

Slim Led Magnetic Track Pendant Light

Rise

Technical Operating & Electrical Data

Operating Voltage	DC48V
IP Rating	IP20
Body Material	Aluminum
Rated CRI	95
Body Color	Black
Beam Angle	24°
Dimming	Non-Dimmable
Lifespan	30000H
Switching Cycle	100000x on/off
Warranty Period	36 Months

Areas of Application

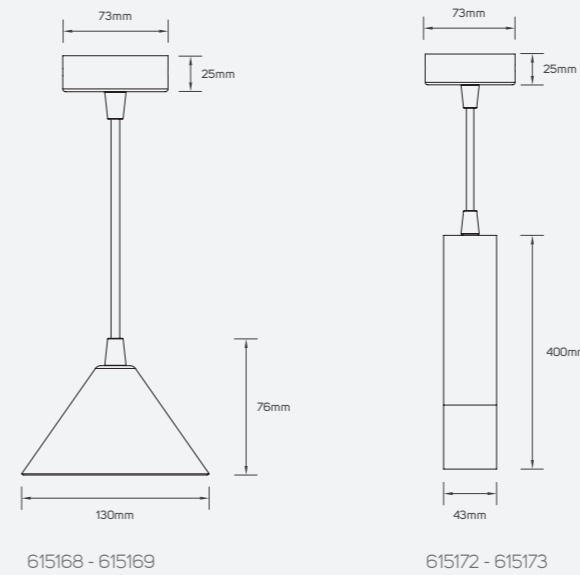
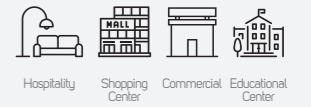

Family Product List

Code No.	Model No.	Power	Lumen	Efficacy	CCT	Current	Saving Energy	Equivalent
● 615168	ILS5WSMPL930WW01	5W	390lm	78lm/W	3000K	100mA	86%	35W
● 615169	ILS5WSMPL940NW01	5W	410lm	82lm/W	4000K	100mA	86%	36W
● 615172	ILS5WSMPL930WW03	5W	380lm	76lm/W	3000K	100mA	85%	34W
● 615173	ILS5WSMPL940NW03	5W	400lm	80lm/W	4000K	100mA	86%	35W



Slim Led Magnetic Track Linear Light

PRODUCT INFORMATION

- Modern looking, neat luminaire offering comfortable, good quality lighting and can also work as a design element.
- Ideal lighting in the non-working areas of professional spaces such as offices, educational institutes, and also the welcoming areas and entrances of retail spaces.
- ILLUS SLIM LED MAGNETIC TRACK LINEAR LIGHT gives the customer the flexibility to choose between 8 models based on their specific need with lumen package from 415lm to 900lm.

BENEFITS

- Clean and uniform light.
- Multiple application use.
- Easy to install and maintain.

FEATURES

- High CRI>95.
- Efficacy up to 75lm/W.
- Long lifespan 30,000H.
- Operating voltage DC48V.
- Non-Dimmable.

Slim Led Magnetic Track Linear Light

Pavo

Technical Operating & Electrical Data

Operating Voltage	DC48V
IP Rating	IP20
Body Material	Aluminum
Rated CRI	95
Body Color	Black
Ambient Temperature	-20°C-45°C
Dimming	Non-Dimmable
Lifespan	30000H
Switching Cycle	100000x on/off
Warranty Period	36 Months

Areas of Application

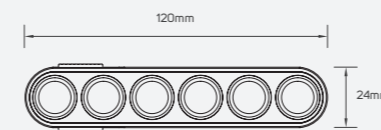
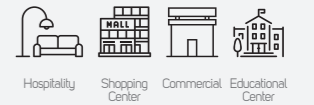

615112 - 615113

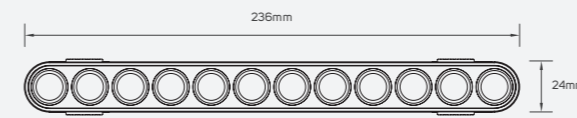

615116 - 615117

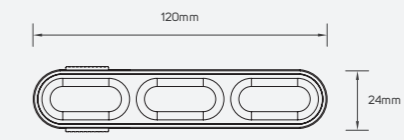

615120 - 615121

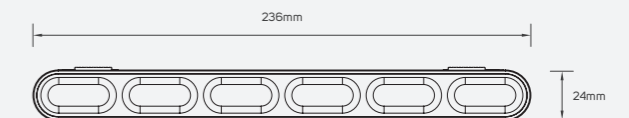

615124 - 615125

Family Product List

Code No.	Model No.	Power	Lumen	Efficacy	CCT	Beam Angle	Saving Energy	Current	Equivalent
● 615112	ILS6W24DSMGF930WW01	6W	415lm	69.17lm/W	3000K	24°	90%	120mA	58W
● 615113	ILS6W24DSMGF940NW01	6W	440lm	73.33lm/W	4000K	24°	90%	120mA	62W
● 615116	ILS12W24DSMGF930WW01	12W	850lm	70.83lm/W	3000K	24°	90%	250mA	116W
● 615117	ILS12W24DSMGF940NW01	12W	900lm	75lm/W	4000K	24°	90%	250mA	122W
● 615120	ILS6W90DSMGF930WW01	6W	400lm	66.67lm/W	3000K	80°	89%	120mA	57W
● 615121	ILS6W90DSMGF940NW01	6W	420lm	70lm/W	4000K	80°	90%	120mA	60W
● 615124	ILS12W90DSMGF930WW01	12W	780lm	65lm/W	3000K	80°	89%	250mA	107W
● 615125	ILS12W90DSMGF940NW01	12W	830lm	69.17lm/W	4000K	80°	89%	250mA	113W

LED Driver

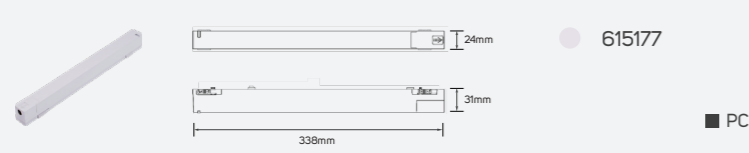

● 615177

■ PC

Surface-Mounted Magnetic Track Rail

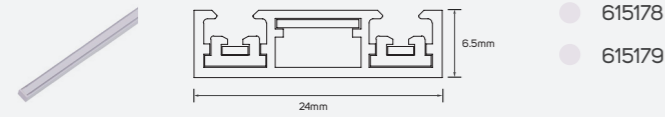

● 615178

● 615179

■ Aluminum+Copper

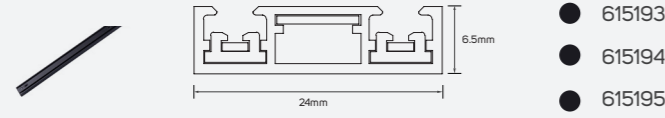

● 615193

● 615194

● 615195

● 615196

■ Aluminum+Copper

Recessed Magnetic Track Rail

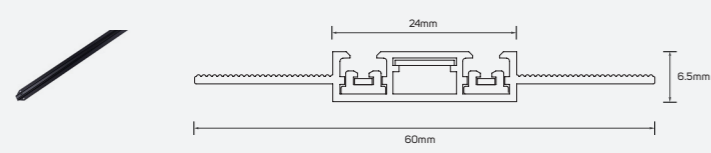

● 615197

● 615198

● 615199

● 615200

■ Aluminum+Copper

I Type Connector

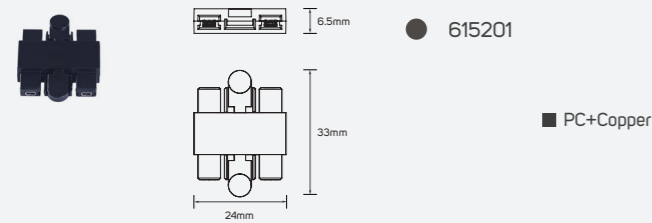

● 615201

■ PC+Copper

T Type Connector

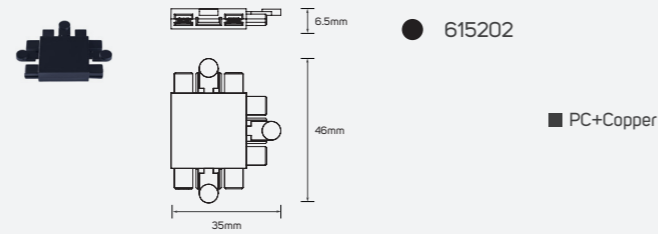

● 615202

■ PC+Copper

L Type Connector

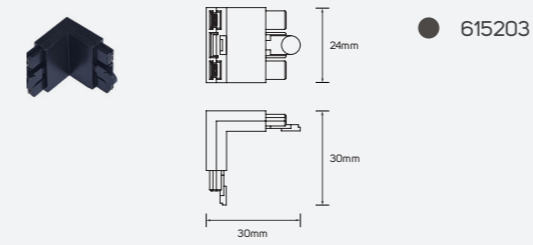

● 615203

■ PC+Copper

Z Type Connector

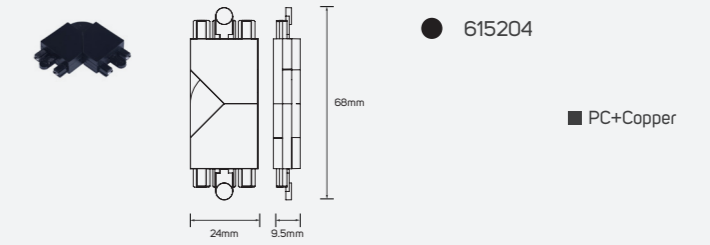

● 615204

■ PC+Copper

X Type Connector

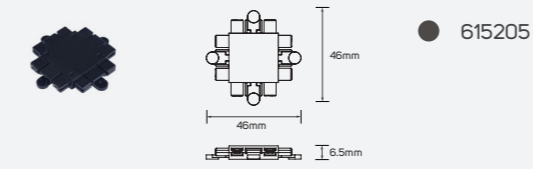

● 615205

■ PC+Copper

End cap

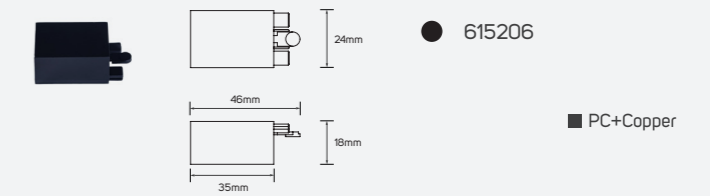

● 615206

■ PC+Copper

Connector

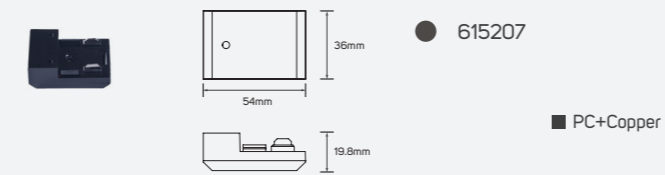

● 615207

■ PC+Copper



LED Magnetic Track Linear Light (Black Version)

Areas of Application

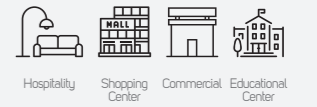

Rhythmic Joy

Technical Operating & Electrical Data

Operating Voltage	DC48V
IP Rating	IP20
Body Material	Aluminum
Rated CRI	90
Body Color	Sandy Black
Beam Angle	30°
Mounting Type	Surface Mounted
Lifespan	30000H

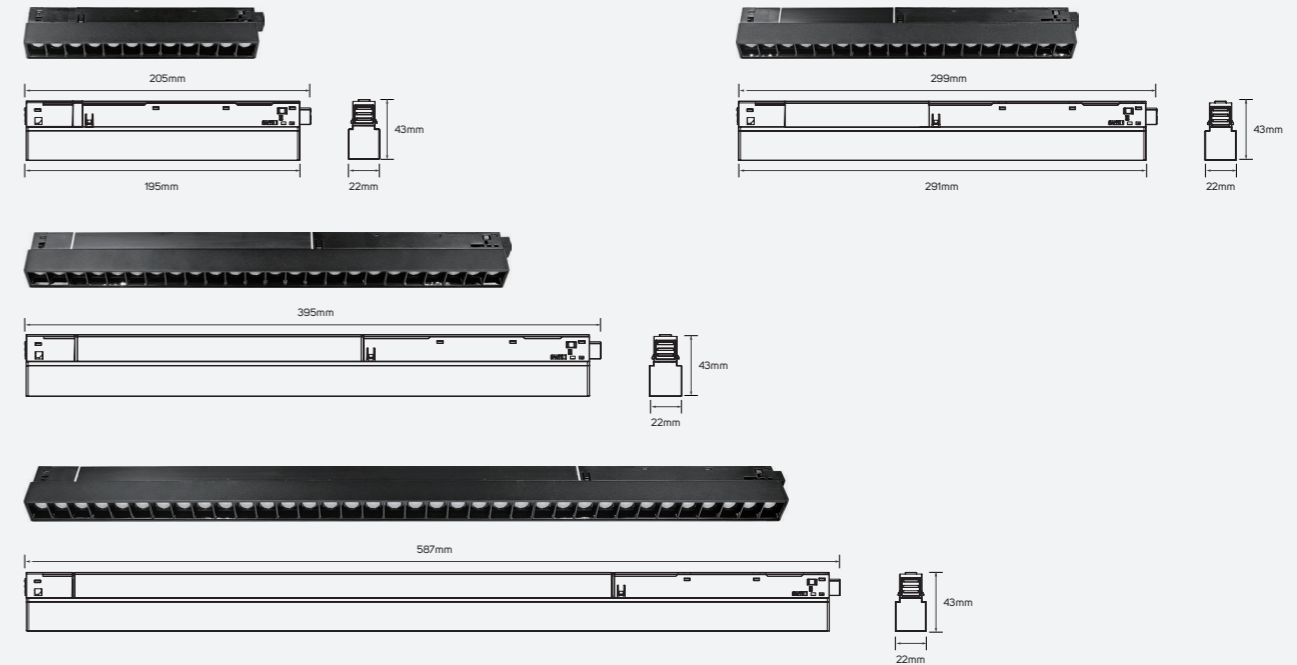

LED Magnetic Track Linear Light (Black Version)

PRODUCT INFORMATION

- Modern looking, neat luminaire offering comfortable, good quality lighting and can also work as a design element.
- Ideal lighting in the non-working areas of professional spaces such as offices, educational institutes, and also the welcoming areas and entrances of retail spaces.
- ILLUS LED MAGNETIC TRACK LINEAR Light gives the customer the flexibility to choose between 8 models based on their specific need with lumen package from 750 lm to 2250 lm.

BENEFITS

- Clean and uniform light.
- Multiple application use.
- Easy to install and maintain.

FEATURES

- High CRI>90.
- Efficacy up to 98 lm/w.
- Long life span 30,000 hrs.
- Operating voltage DC48 V.
- Non – dimmable.

Family Product List

Code No.	Model No.	Power	Lumen	Efficacy	CCT
● 613629	ILS9W36DMTL930WW01	8.5W	750lm	88.24lm/W	3000K
● 613630	ILS9W36DMTL940NW01	8.5W	800lm	94.12lm/W	4000K
● 613631	ILS15W36DMTL930WW01	14.5W	1300lm	89.66lm/W	3000K
● 613632	ILS15W36DMTL940NW01	14.5W	1370lm	94.48lm/W	4000K
● 613633	ILS20W36DMTL930WW01	20W	1650lm	82.50lm/W	3000K
● 613634	ILS20W36DMTL940NW01	20W	1750lm	87.50lm/W	4000K
● 613635	ILS24W110DMTL930WW01	23W	2050lm	89.13lm/W	3000K
● 613636	ILS24W110DMTL940NW01	23W	2250lm	97.83lm/W	4000K

Recessed Magnetic Track Rail

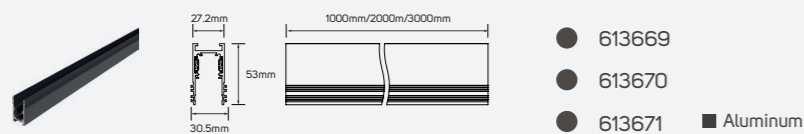

Pendant Magnetic Track Rail

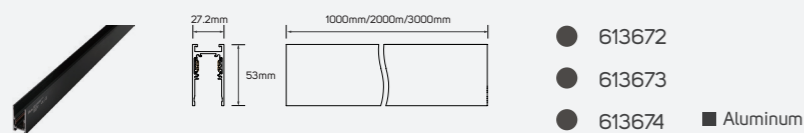

48V Magnetic Driver

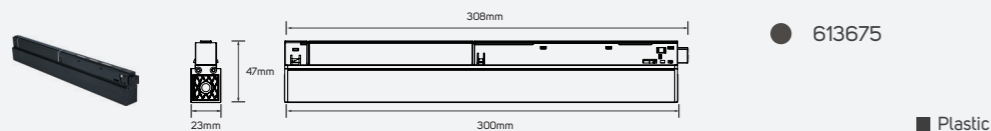

Recessed Horizontal Corner

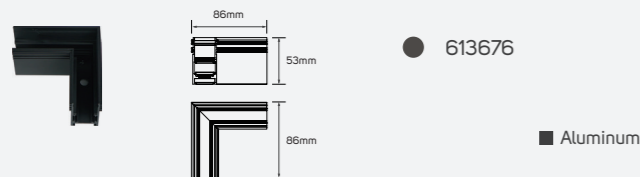

Recessed Inside Corner

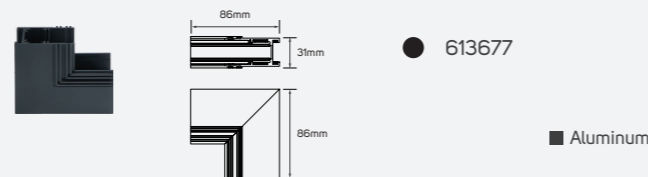

Surface Mounted Horizontal Corner

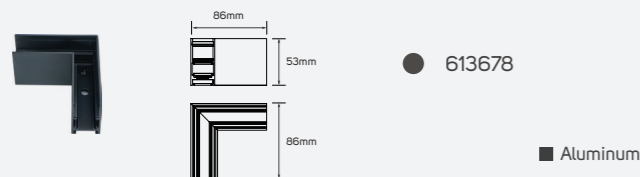

Surface Mounted Inside Corner

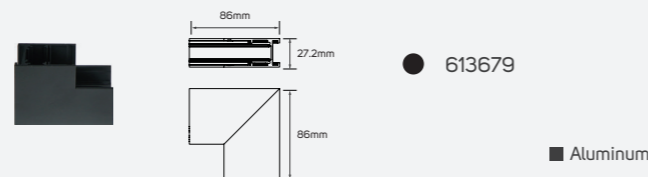

Flexible Corner Conductive Module

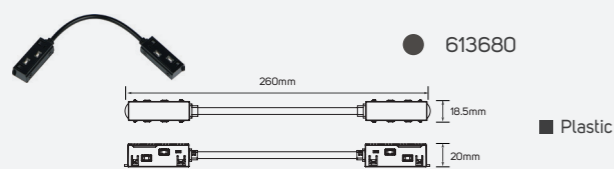

Direct Corner Conductive Module

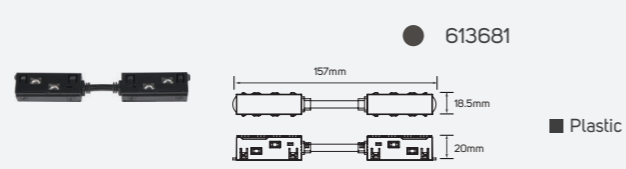

Cable Wire

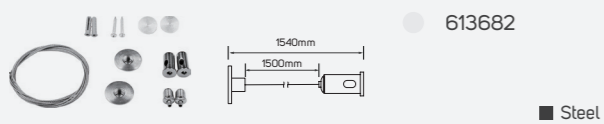

Cable Wire

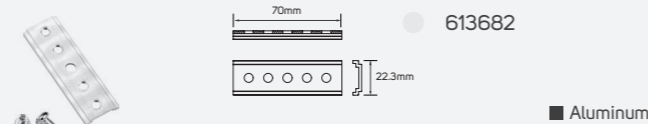

LED Magnetic Track Linear Light (Black Version)

Rhythmic Joy

Technical Operating & Electrical Data

Operating Voltage	DC48V
IP Rating	IP20
Body Material	Aluminum
Rated CRI	90
Body Color	Sandy Black
Beam Angle	30°
Mounting Type	Surface Mounted
Lifespan	30000H

Areas of Application

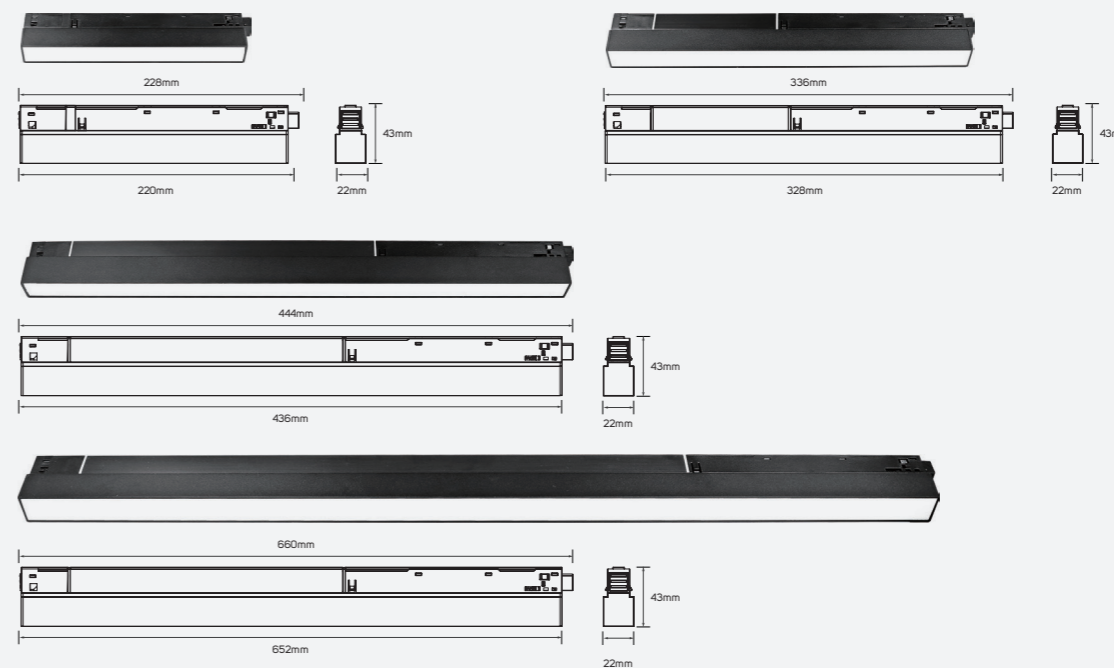
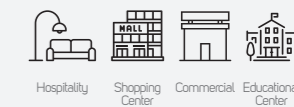

Family Product List

Code No.	Model No.	Power	Lumen	Efficacy	CCT
● 613643	ILS9W110DMTL930WW03	8W	570lm	71.25lm/W	3000K
● 613644	ILS9W110DMTL940NW03	8W	600lm	75lm/W	4000K
● 613645	ILS15W110DMTL930WW03	15W	1110lm	74lm/W	3000K
● 613646	ILS15W110DMTL940NW03	15W	1170lm	78lm/W	4000K
● 613647	ILS20W110DMTL930WW03	21W	1600lm	76.19lm/W	3000K
● 613648	ILS20W110DMTL940NW03	21W	1700lm	80.95lm/W	4000K
● 613649	ILS24W110DMTL930WW03	24W	1750lm	72.92lm/W	3000K
● 613650	ILS24W110DMTL940NW03	24W	1900lm	79.17lm/W	4000K

Recessed Magnetic Track Rail

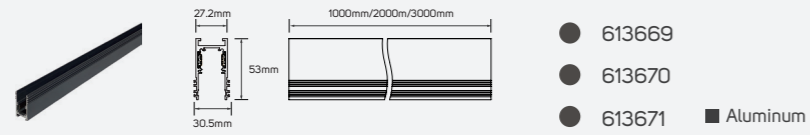

Pendant Magnetic Track Rail

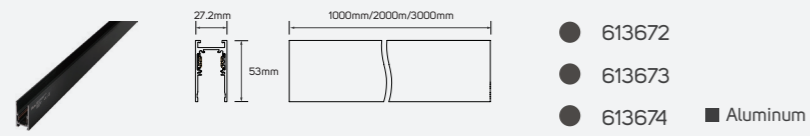

48V Magnetic Driver

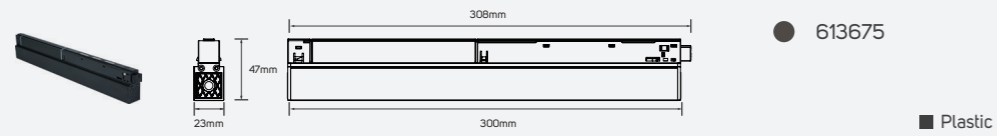

Recessed Horizontal Corner

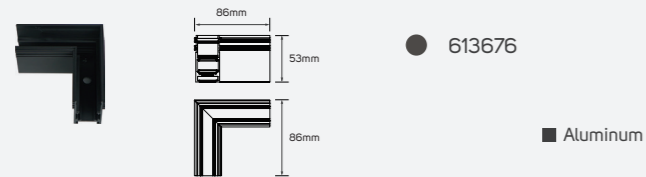

Recessed Inside Corner

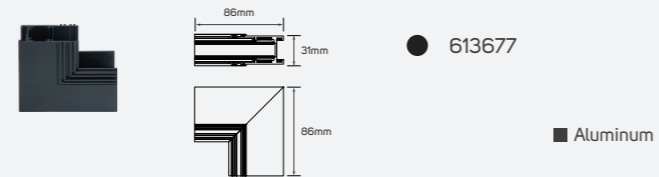

Surface Mounted Horizontal Corner

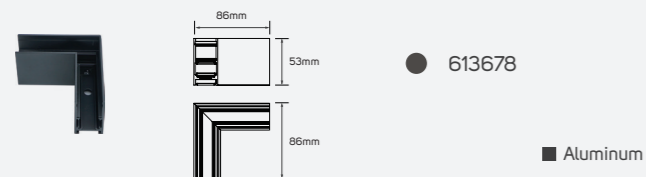

Surface Mounted Inside Corner

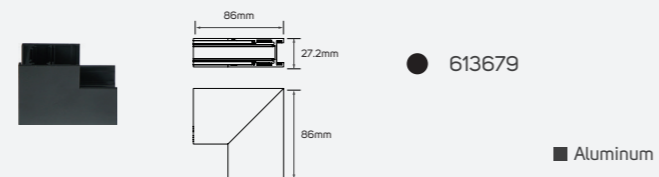

Flexible Corner Conductive Module

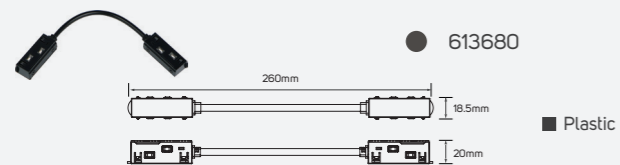

Direct Corner Conductive Module

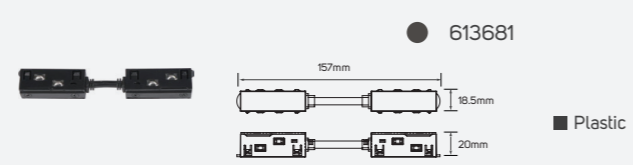

Cable Wire

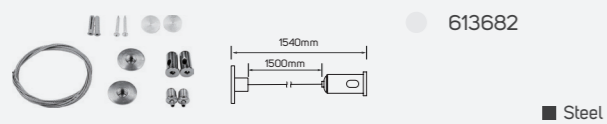

Cable Wire

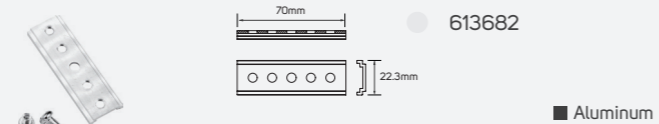

Rhythmic Joy

Technical Operating & Electrical Data

Input Voltage & Frequency	AC220-240V , 50/60Hz
IP Rating	IP20
Body Material	Aluminum
Rated CRI	95
Body Color	Black
Beam Angle	90°
Lifespan	30000H

Areas of Application

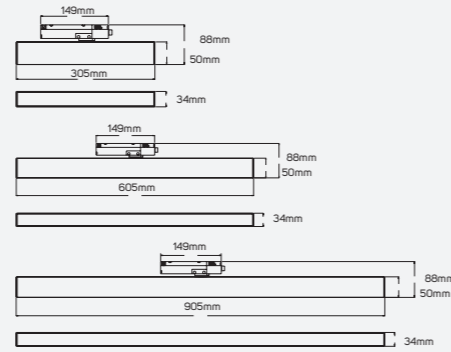
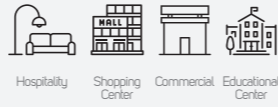

Family Product List

Code No.	Model No.	Power	Lumen	Efficacy	CCT
● 614383	ILS12FTRKL930WW01	12W	850lm	70.83lm/w	3000K
● 614384	ILS12FTRKL940NW01	12W	900lm	75lm/w	4000K
● 614385	ILS26FTRKL930WW01	26W	1850lm	69.23lm/w	3000K
● 614386	ILS26FTRKL940NW01	26W	1920lm	73.85lm/w	4000K
● 614387	ILS33FTRKL930WW01	33W	2350lm	71.21lm/w	3000K
● 614388	ILS33FTRKL940NW01	33W	2500lm	75.76lmw	4000K





LED Adjustable Magnetic Track Linear Light (Black Version)

Areas of Application

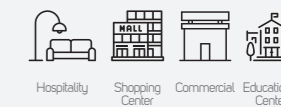

Rhythmic Joy

Technical Operating & Electrical Data

Operating Voltage	DC48V
IP Rating	IP20
Body Material	Aluminum
Rated CRI	90
Body Color	Sandy Black
Beam Angle	30°
Mounting Type	Surface Mounted

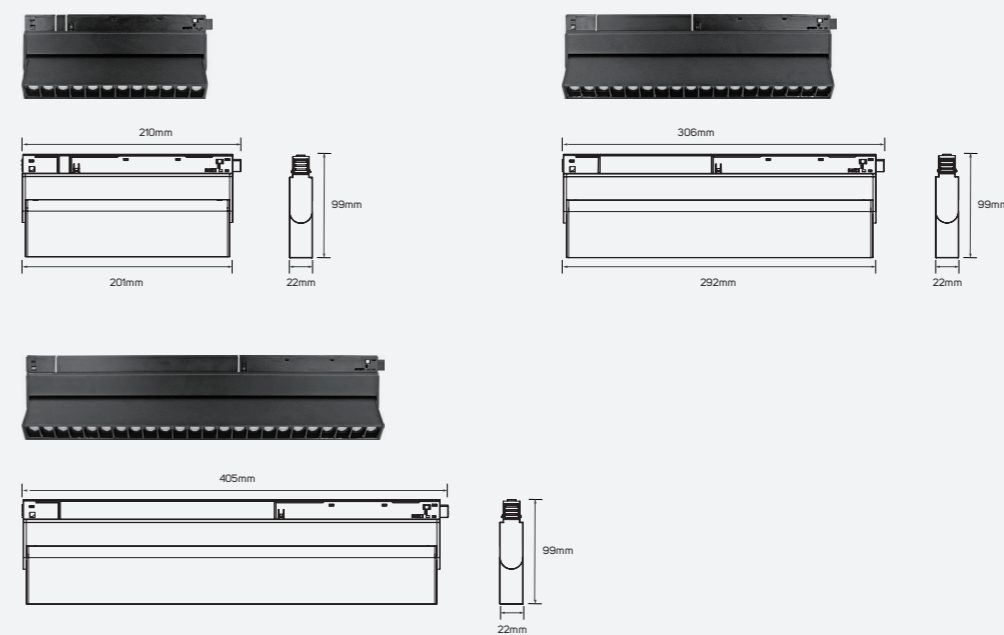

LED Adjustable Magnetic Track Linear Light (Black Version)

PRODUCT INFORMATION

- Modern looking, neat luminaire offering comfortable, good quality lighting and can also work as a design element.
- Ideal lighting in the non-working areas of professional spaces such as offices, educational institutes, and also the welcoming areas and entrances of retail spaces.
- ILLUS LED MAGNETIC TRACK LINEAR Light gives the customer the flexibility to choose between 6 models based on their specific need with lumen package from 750 lm to 1850 lm.

BENEFITS

- Clean and uniform light.
- Multiple application use.
- Easy to install and maintain.

FEATURES

- High CRI>90.
- Efficacy up to 94 lm/w.
- Long life span 30,000 hrs.
- Operating voltage DC48 V.
- Non – dimmable.

Family Product List

Code No.	Model No.	Power	Lumen	Efficacy	CCT
● 613637	ILS9W36DMTL930WW02	8.5W	750lm	88.24lm/W	3000K
● 613638	ILS9W36DMTL940NW02	8.5W	800lm	94.12lm/W	4000K
● 613639	ILS15W36DMTL930WW02	15W	1300lm	86.67lm/W	3000K
● 613640	ILS15W36DMTL940NW02	15W	1370lm	91.33lm/W	4000K
● 613641	ILS20W36DMTL930WW02	20W	1750lm	87.50lm/W	3000K
● 613642	ILS20W36DMTL940NW02	20W	1850lm	92.50lm/W	4000K

Recessed Magnetic Track Rail

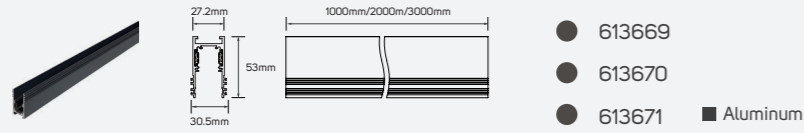

Pendant Magnetic Track Rail

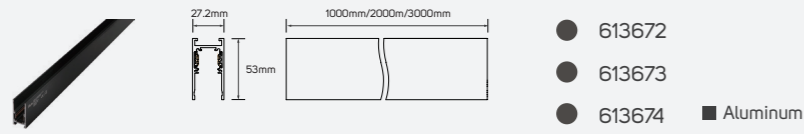

48V Magnetic Driver

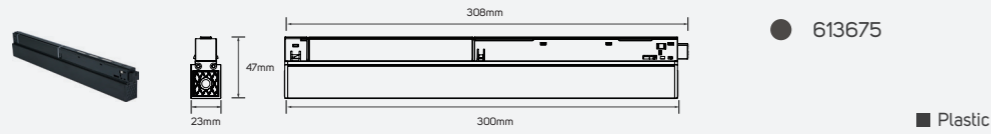

Recessed Horizontal Corner

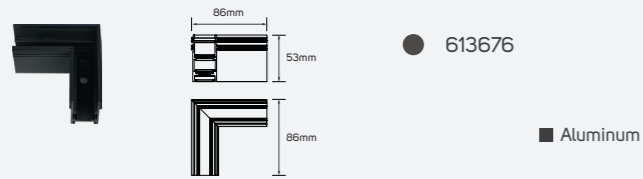

Recessed Inside Corner

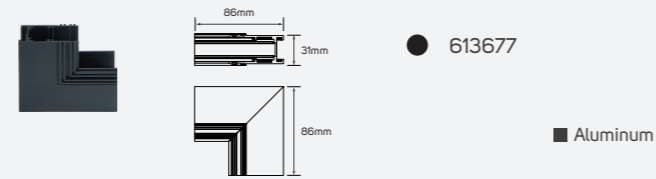

Surface Mounted Horizontal Corner

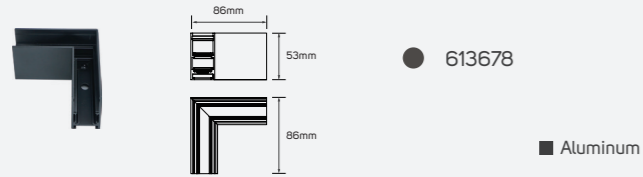

Surface Mounted Inside Corner

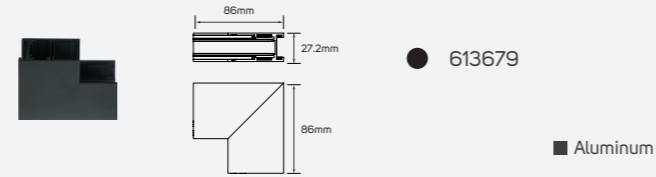

Flexible Corner Conductive Module

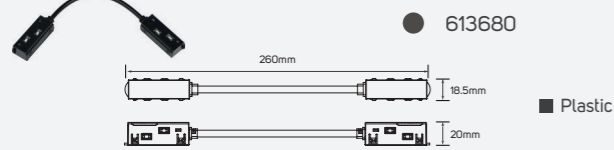

Direct Corner Conductive Module

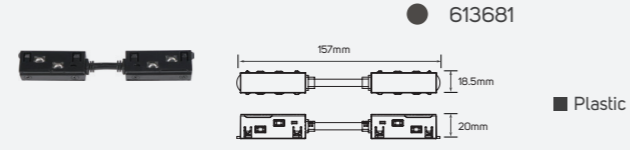

Cable Wire

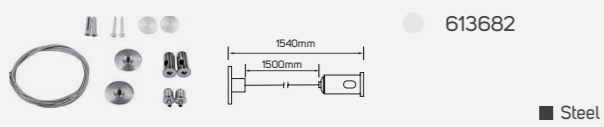

Cable Wire

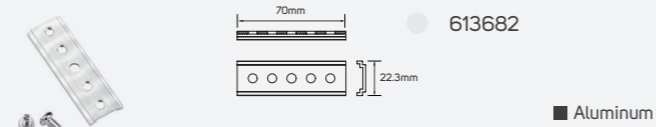

LED Adjustable Magnetic Track Linear Light (Black Version)

Rhythmic Joy

Technical Operating & Electrical Data

Operating Voltage	DC48V
IP Rating	IP20
Body Material	Aluminum
Rated CRI	90
CCT	3000K
Beam Angle	45°
Dimming	Non-Dimmable
Lifespan	30000H

Areas of Application

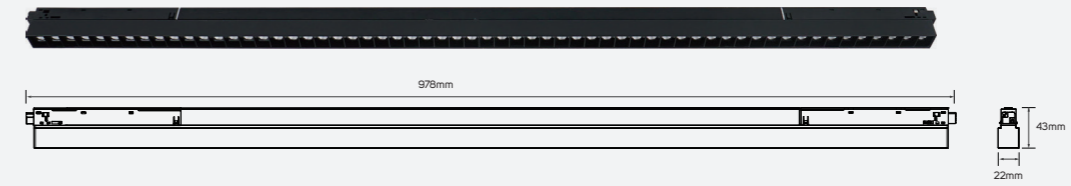

614595



614596

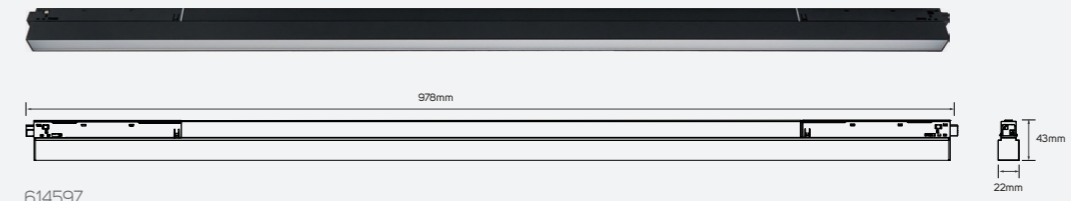

614597

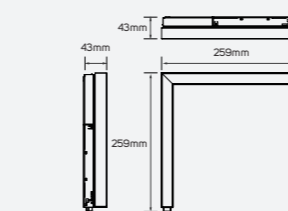
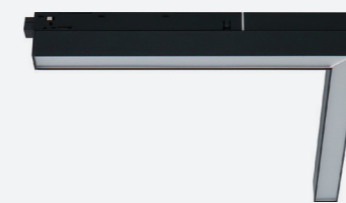

614598

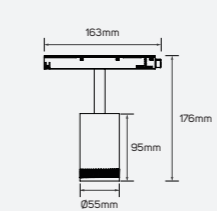

614599

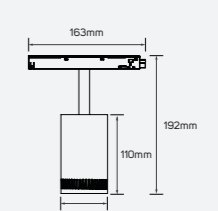

614600

Flexible Conductive Module

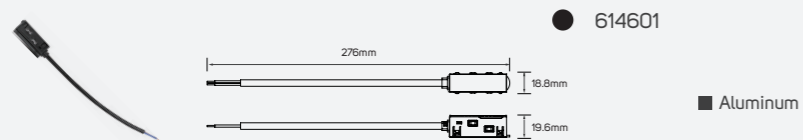

Family Product List

Code No.	Model No.	Body Color	Power	Lumen	Efficacy	Beam Angle
614595	ILS38W28DML930WW01	Sandy black	38W	3450lm	90.79lm/W	30°
614596	ILS38W28DAML930WW01	Sandy black	38W	3450lm	90.79lm/W	30°
614597	ILS38W90DFMTL930WW01	Sandy black	38W	2800lm	73.68lm/W	90°
614598	ILS20W110DLMTL930WW01	Sandy black	20W	1500lm	75lm/W	90°
614599	ILS8WZMTL930WW01	Sandy black	8W	750lm	93.75lm/W	15°-55°
614600	ILS16WZMTL930WW01	Sandy black	16W	1500lm	93.75lm/W	15°-55°
614649	ILS38W28DML930WW02	Sandy White	38W	3450lm	90.79lm/W	30°
614650	ILS38W28DAML930WW02	Sandy White	38W	3450lm	90.79lm/W	30°
614651	ILS38W90DFMTL930WW02	Sandy White	38W	2800lm	73.68lm/W	90°
614652	ILS20W110DLMTL930WW02	Sandy White	20W	1500lm	75lm/W	90°
614653	ILS8WZMTL930WW02	Sandy White	8W	750lm	93.75lm/W	15°-55°
614654	ILS16WZMTL930WW02	Sandy White	16W	1500lm	93.75lm/W	15°-55°



Rhythmic Joy

Technical Operating & Electrical Data

Input Voltage & Frequency	AC220-240V , 50/60Hz
IP Rating	IP20
Body Material	Aluminum
Rated CRI	95
Body Color	Black
Beam Angle	30°
Lifespan	30000H

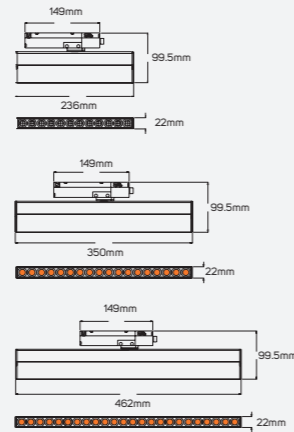

Family Product List

Code No.	Model No.	Power	Lumen	Efficacy	CCT
● 614389	ILS12AGTRKL930WW01	12W	1050lm	87.50lm/w	3000K
● 614390	ILS12AGTRKL940NW01	12W	1100lm	91.67lm/w	4000K
● 614391	ILS19AGTRKL930WW01	19W	1650lm	86.84lm/w	3000K
● 614392	ILS19AGTRKL940NW01	19W	1720lm	90.53lm/w	4000K
● 614393	ILS23AGTRKL930WW01	23W	2100lm	91.30lm/w	3000K
● 614394	ILS23AGTRKL940NW01	23W	2200lm	95.65lm/w	4000K

Rhythmic Joy

Technical Operating & Electrical Data

Input Voltage & Frequency	AC220-240V , 50/60Hz
IP Rating	IP20
Body Material	Aluminum
Rated CRI	95
Body Color	Black
Beam Angle	90°
Lifespan	30000H

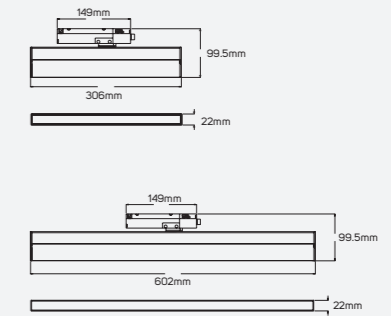

Family Product List

Code No.	Model No.	Power	Lumen	Efficacy	CCT
● 614395	ILS12AFTRKL930WW01	12W	850lm	70.83lm/w	3000K
● 614396	ILS12AFTRKL940NW01	12W	900lm	75lm/w	4000K
● 614397	ILS22AFTRKL930WW01	22W	1550lm	70.45lm/w	3000K
● 614398	ILS22AFTRKL940NW01	22W	1650lm	75lm/w	4000K



LED Magnetic Track Spot Light (Black Version)

Planet

Technical Operating & Electrical Data

Operating Voltage	DC48V
IP Rating	IP20
Body Material	Aluminum
Rated CRI	90
Body Color	Sandy Black
Beam Angle	24°
Mounting Type	Track Mounted
Lifespan	30000H

Areas of Application

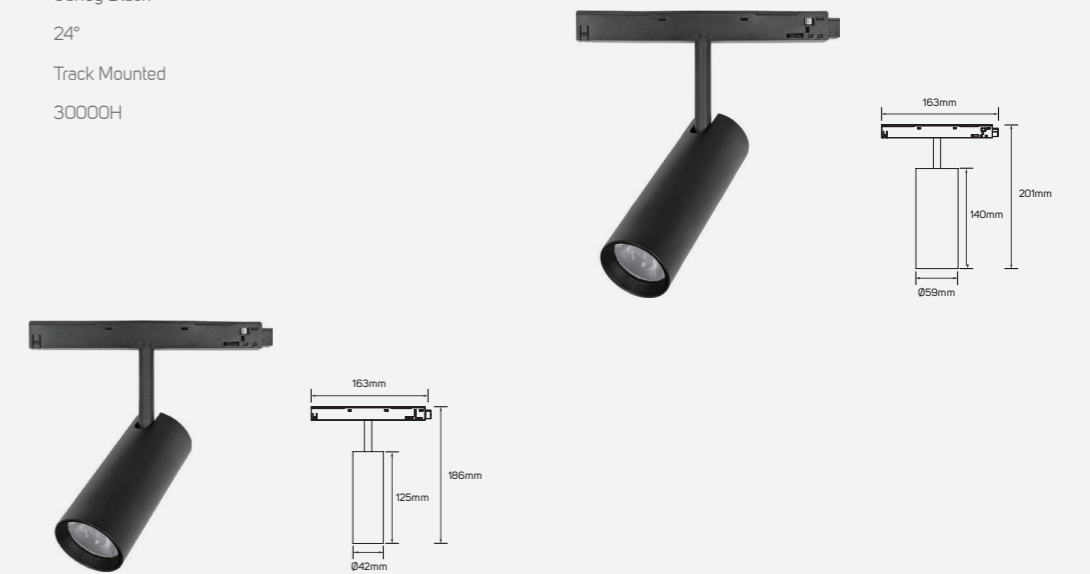
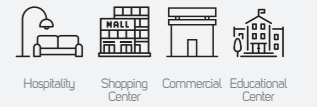

LED Magnetic Track Spot Light (Black Version)

PRODUCT INFORMATION

- Modern looking, neat luminaire offering comfortable, good quality lighting and can also work as a design element.
- Ideal lighting in the non-working areas of professional spaces such as offices, educational institutes, and also the welcoming areas and entrances of retail spaces.
- ILLUS LED MAGNETIC TRACK SPOT Light gives the customer the flexibility to choose between 6 models based on their specific need with lumen package from 800 lm to 1450 lm.

BENEFITS

- Clean and uniform light.
- Multiple application use.
- Easy to install and maintain.

FEATURES

- High CRI>90.
- Efficacy up to 106 lm/w.
- Long life span 30,000 hrs.
- Operating voltage DC48 V.
- Non – dimmable.

Family Product List

Code No.	Model No.	Power	Lumen	Efficacy	CCT
● 613651	ILS9W24DMTSL930WW01	8W	800lm	100lm/W	3000K
● 613652	ILS9W24DMTSL940NW01	8W	850lm	106.25lm/W	4000K
● 613653	ILS12W24DMTSL930WW01	12.5W	1150lm	92lm/W	3000K
● 613654	ILS12W24DMTSL940NW01	12.5W	1220lm	97.60lm/W	4000K
● 613655	ILS18W24DMTSL930WW01	16W	1350lm	84.38lm/W	3000K
● 613656	ILS18W24DMTSL940NW01	16W	1450lm	90.63lm/W	4000K

Recessed Magnetic Track Rail

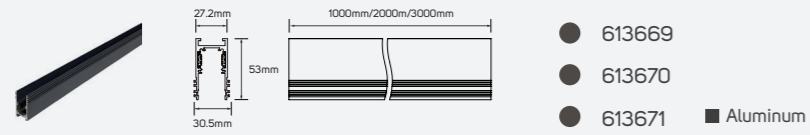

Pendant Magnetic Track Rail

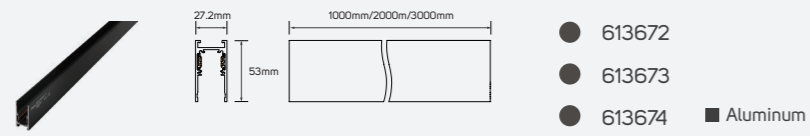

48V Magnetic Driver

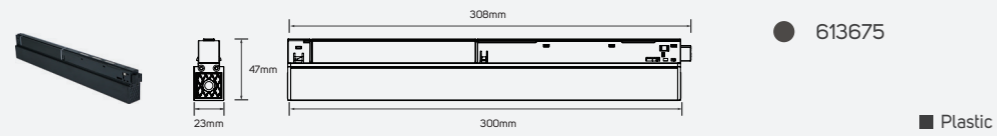

Recessed Horizontal Corner

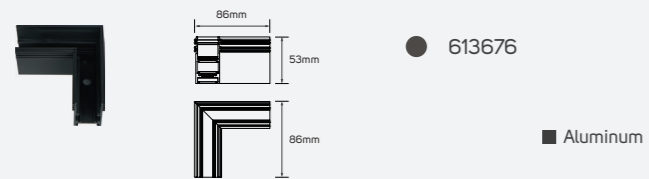

Recessed Inside Corner

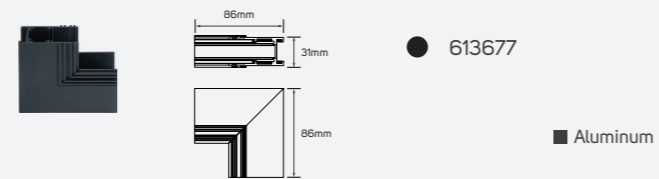

Surface Mounted Horizontal Corner

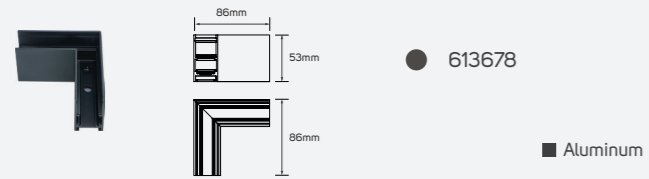

Surface Mounted Inside Corner

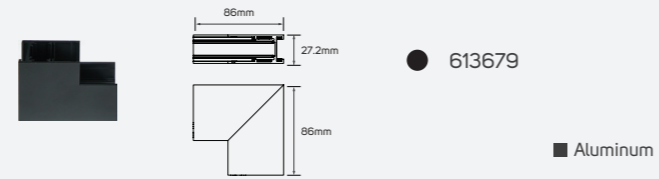

Flexible Corner Conductive Module

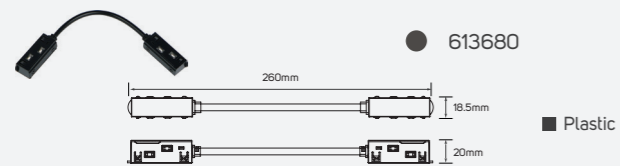

Direct Corner Conductive Module

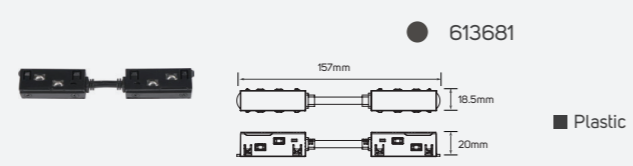

Cable Wire

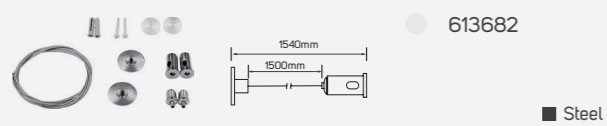

Cable Wire

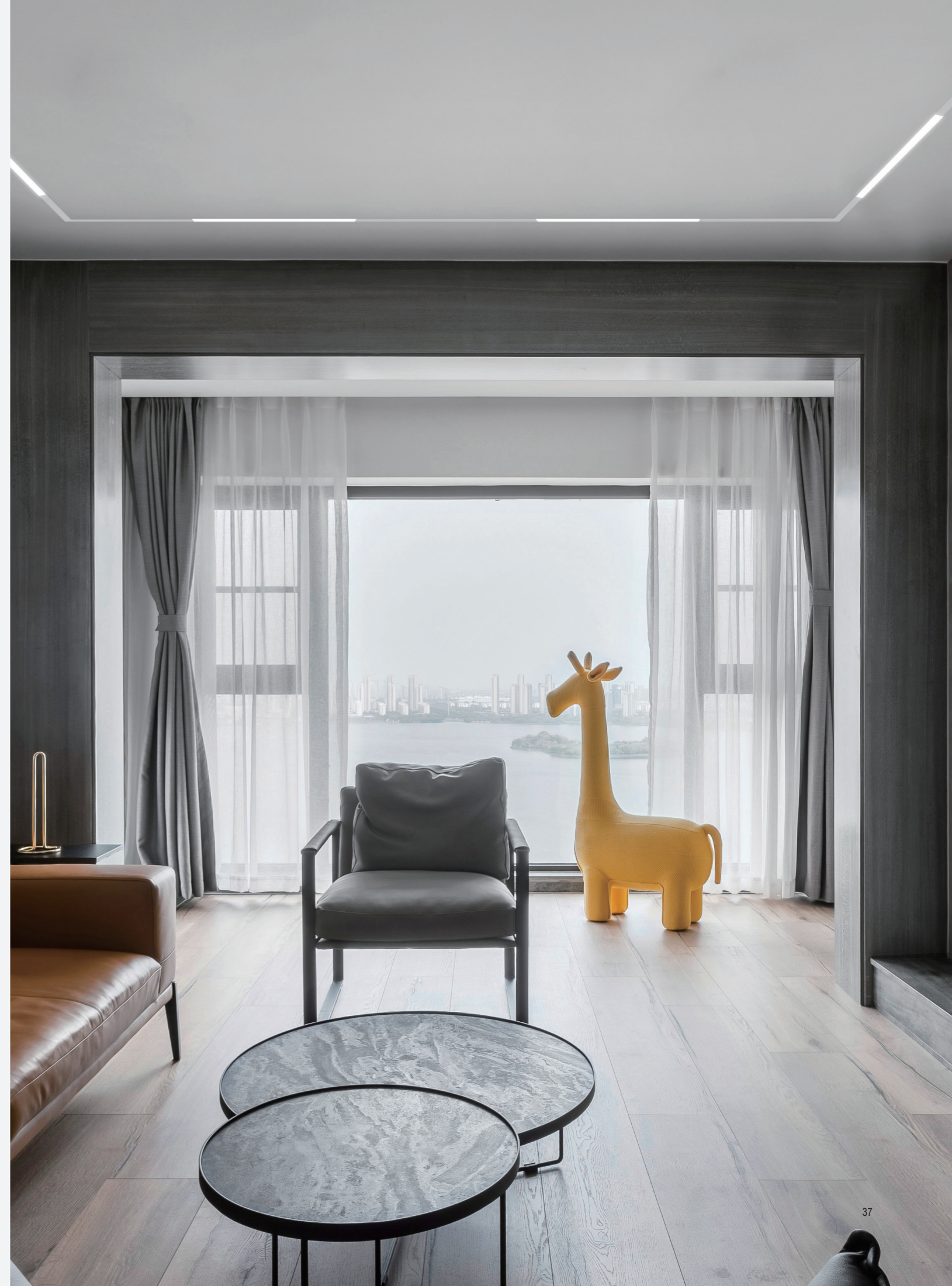
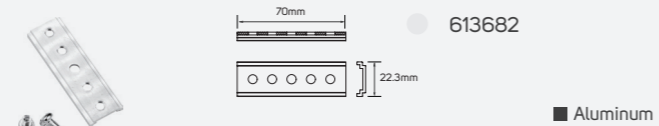



LED Magnetic Track Pendant Light (Black Version)

Areas of Application

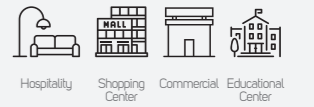

Glorya

Technical Operating & Electrical Data

Operating Voltage	DC48V
IP Rating	IP20
Body Material	Aluminum+Industrial Plastic
Rated CRI	90
Body Color	Sandy Black
Beam Angle	24°
Mounting Type	Track Mounted
Lifespan	30000H

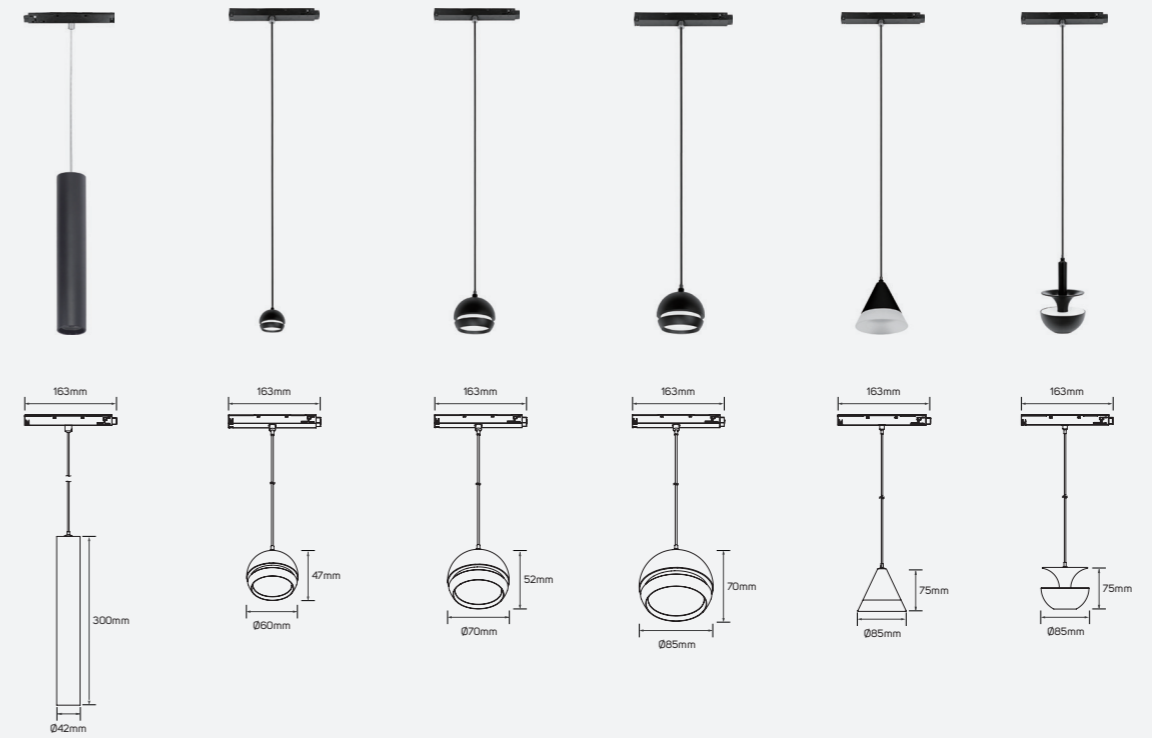

613657 - 613658 613659 - 613660 613661 - 613662 613663 - 613664 613665 - 613666 613667 - 613668

LED Magnetic Track Pendant Light (Black Version)

PRODUCT INFORMATION

- Modern looking, neat luminaire offering comfortable, good quality lighting and can also work as a design element.
- Ideal lighting in the non-working areas of professional spaces such as offices, educational institutes, and also the welcoming areas and entrances of retail spaces.
- ILLUS LED MAGNETIC TRACK SPOT Light gives the customer the flexibility to choose between 12 models based on their specific need with lumen package from 370 lm to 1050 lm.

BENEFITS

- Clean and uniform light.
- Multiple application use.
- Easy to install and maintain.

FEATURES

- High CRI>90.
- Efficacy up to 106 lm/w.
- Long life span 30,000 hrs.
- Operating voltage DC48 V.
- Non - dimmable.

Family Product List

Code No.	Model No.	Power	Lumen	Efficacy	CCT
● 613657	ILS9W24DMTPL930WW01	8.5W	850lm	100lm/W	3000K
● 613658	ILS9W24DMTPL940NW01	8.5W	900lm	105.88lm/W	4000K
● 613659	ILS5W100DMTPL930WW01	5W	450lm	90lm/W	3000K
● 613660	ILS5W100DMTPL940NW01	5W	480lm	96lm/W	4000K
● 613661	ILS7W100DMTPL930WW01	7W	650lm	92.86lm/W	3000K
● 613662	ILS7W100DMTPL940NW01	7W	700lm	100lm/W	4000K
● 613663	ILS12W100DMTPL930WW01	12W	950lm	79.17lm/W	3000K
● 613664	ILS12W100DMTPL940NW01	12W	1050lm	87.50lm/W	4000K
● 613665	ILS5W24DMTPL930WW01	4.5W	370lm	82.22lm/W	3000K
● 613666	ILS5W24DMTPL940NW01	4.5W	450lm	100lm/W	4000K
● 613667	ILS5W24DMTPL930WW02	4.5W	380lm	84.44lm/W	3000K
● 613668	ILS5W24DMTPL940NW02	4.5W	400lm	88.89lm/W	4000K

Recessed Magnetic Track Rail

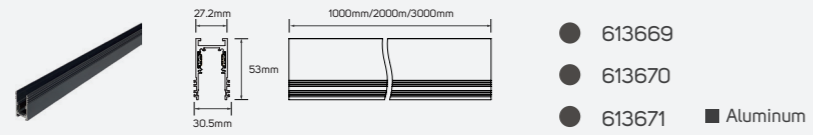

Pendant Magnetic Track Rail

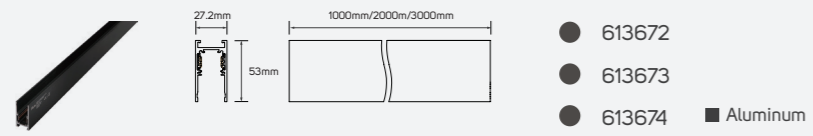

48V Magnetic Driver

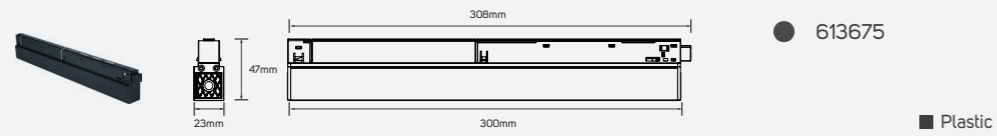

Recessed Horizontal Corner

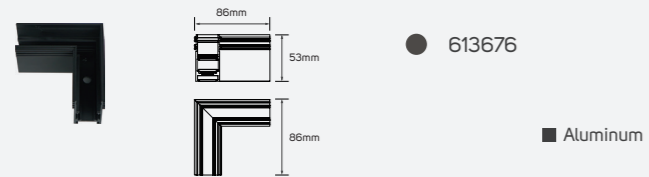

Recessed Inside Corner

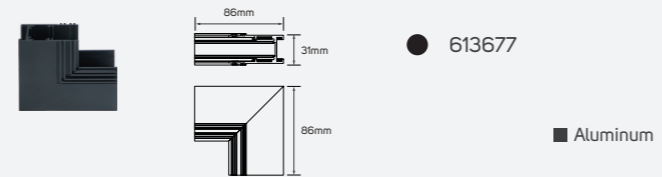

Surface Mounted Horizontal Corner

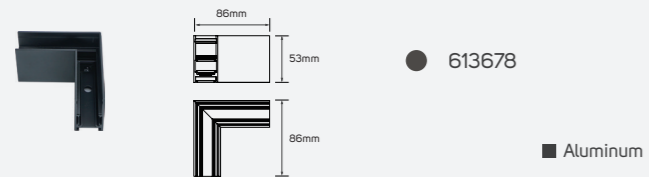

Surface Mounted Inside Corner

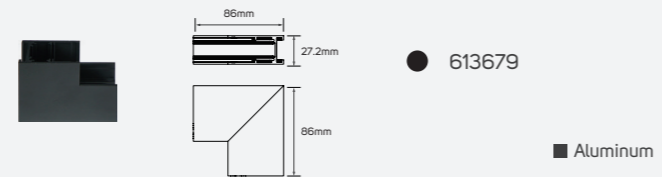

Flexible Corner Conductive Module

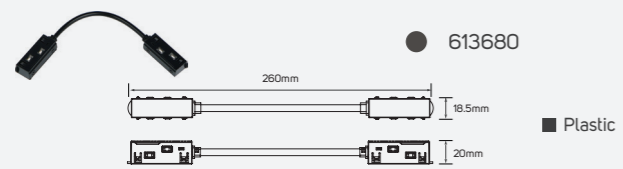

Direct Corner Conductive Module

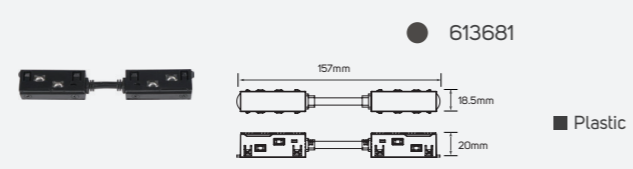

Cable Wire

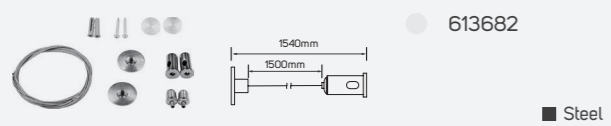

Cable Wire

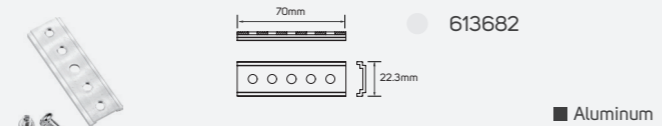



LED Magnetic Track Linear Light (White Version)

Areas of Application



Rhythmic Joy

Technical Operating & Electrical Data

Operating Voltage	DC48V
IP Rating	IP20
Body Material	Aluminum
Rated CRI	90
Body Color	Sandy White
Beam Angle	30°
Mounting Type	Surface Mounted
Lifespan	30000H

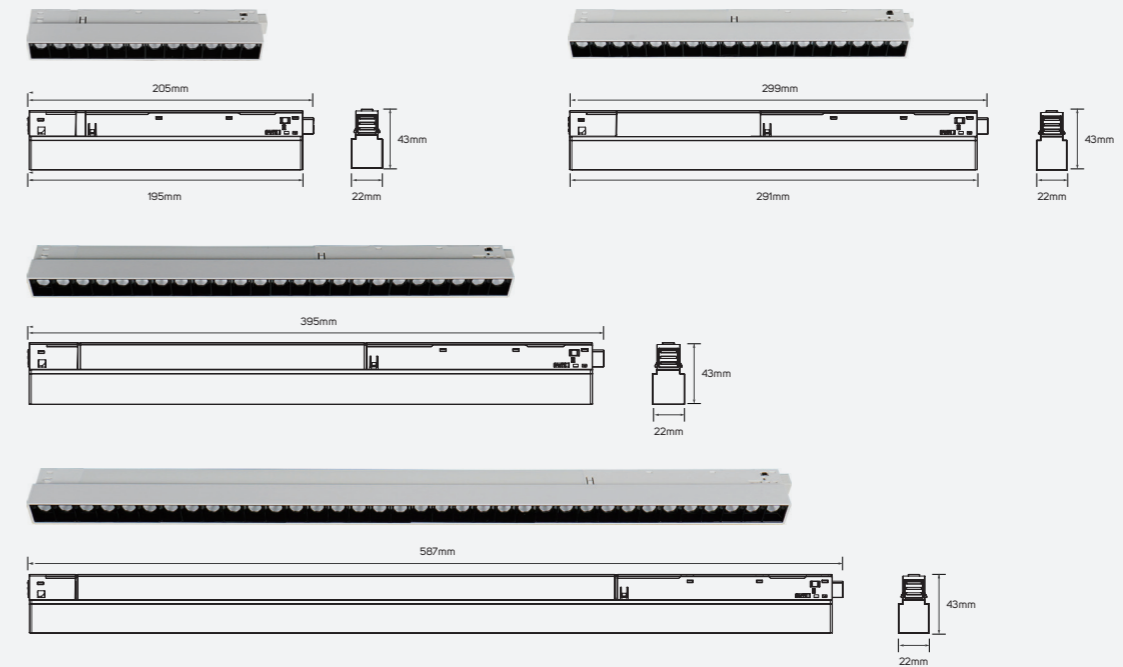

LED Magnetic Track Linear Light (White Version)

PRODUCT INFORMATION

- Modern looking, neat luminaire offering comfortable, good quality lighting and can also work as a design element.
- Ideal lighting in the non-working areas of professional spaces such as offices, educational institutes, and also the welcoming areas and entrances of retail spaces.
- ILLUS LED MAGNETIC TRACK LINEAR Light gives the customer the flexibility to choose between 8 models based on their specific need with lumen package from 750 lm to 2250 lm.

BENEFITS

- Clean and uniform light.
- Multiple application use.
- Easy to install and maintain.

FEATURES

- High CRI>90.
- Efficacy up to 98 lm/w.
- Long life span 30,000 hrs.
- Operating voltage DC48 V.
- Non - dimmable.

Family Product List

Code No.	Model No.	Power	Lumen	Efficacy	CCT
614524	ILS8.5W30DMTL930WWW01	8.5W	750lm	88.24lm/W	3000K
614525	ILS8.5W30DMTL940NWW01	8.5W	800lm	94.12lm/W	4000K
614526	ILS14.5W30DMTL930WWW01	14.5W	1300lm	89.66lm/W	3000K
614527	ILS14.5W30DMTL940NWW01	14.5W	1370lm	94.48lm/W	4000K
614528	ILS20W30DMTL930WWW01	20W	1650lm	82.50lm/W	3000K
614529	ILS20W30DMTL940NWW01	20W	1750lm	87.50lm/W	4000K
614530	ILS23W30DMTL930WWW01	23W	2050lm	89.13lm/W	3000K
614531	ILS23W30DMTL940NWW01	23W	2250lm	97.83lm/W	4000K

Recessed Magnetic Track Rail

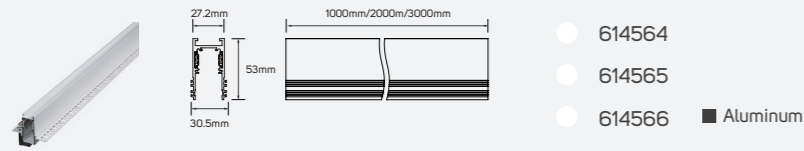

Pendant Magnetic Track Rail

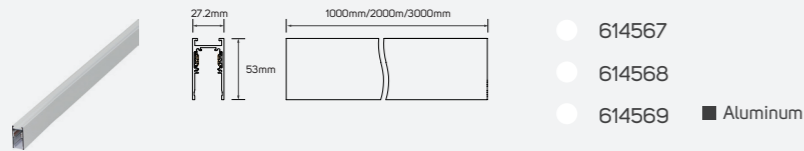

48V Magnetic Driver

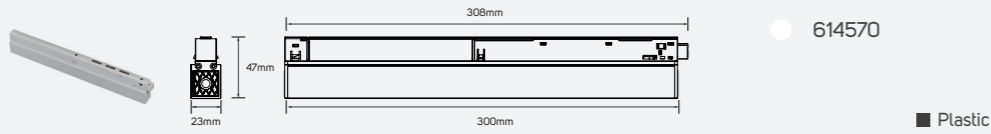

Recessed Horizontal Corner

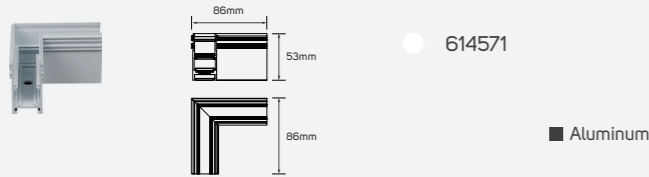

Recessed Inside Corner

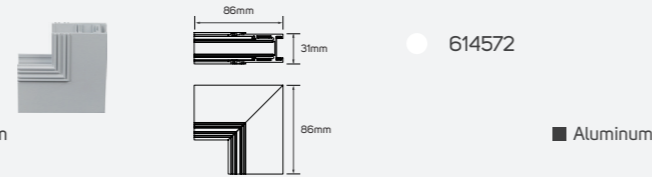

Surface Mounted Horizontal Corner

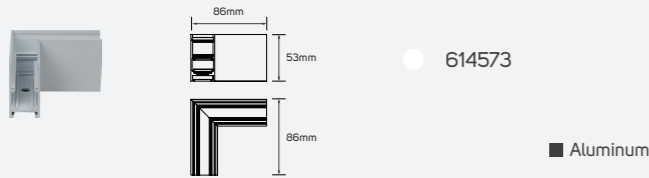

Surface Mounted Inside Corner

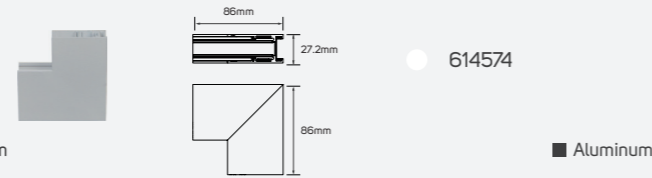

Flexible Corner Conductive Module

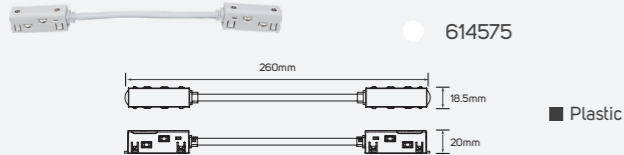

Direct Corner Conductive Module

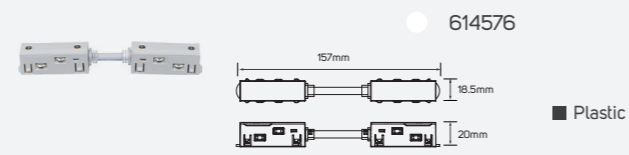

Cable Wire

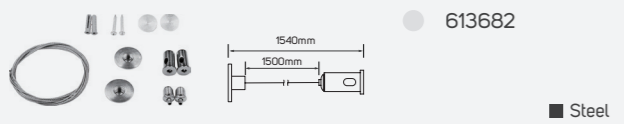

Cable Wire

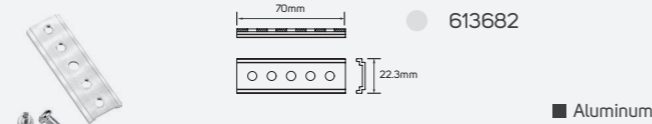

LED Magnetic Track Linear Light (White Version)

Rhythmic Joy

Areas of Application

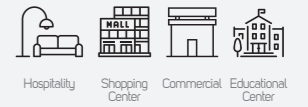

Technical Operating & Electrical Data

Operating Voltage	DC48V
IP Rating	IP20
Body Material	Aluminum
Rated CRI	90
Body Color	Sandy White
Beam Angle	90°
Mounting Type	Surface Mounted
Lifespan	30000H

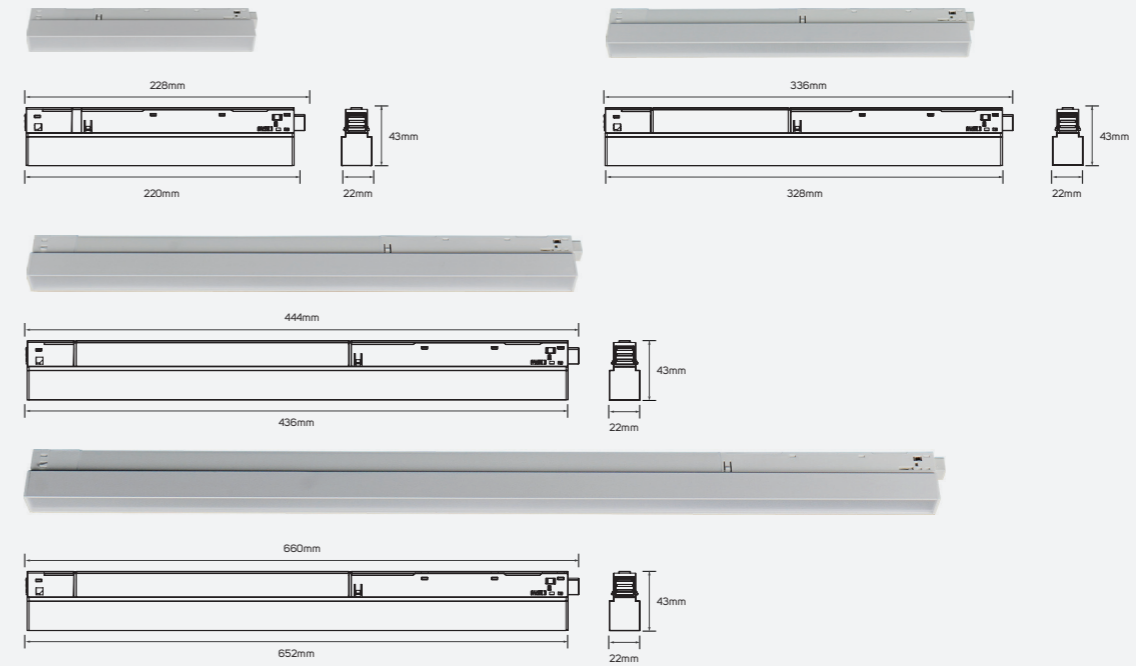

Family Product List

Code No.	Model No.	Power	Lumen	Efficacy	CCT
614538	ILS9W110DMTL930WW03	8W	570lm	71.25lm/W	3000K
614539	ILS9W110DMTL940NW03	8W	600lm	75lm/W	4000K
614540	ILS15W110DMTL930WW03	15W	1110lm	74lm/W	3000K
614541	ILS15W110DMTL940NW03	15W	1170lm	78lm/W	4000K
614542	ILS20W110DMTL930WW03	21W	1600lm	76.19lm/W	3000K
614543	ILS20W110DMTL940NW03	21W	1700lm	80.95lm/W	4000K
614544	ILS24W110DMTL930WW03	24W	1750lm	72.92lm/W	3000K
614545	ILS24W110DMTL940NW03	24W	1900lm	79.17lm/W	4000K

Recessed Magnetic Track Rail

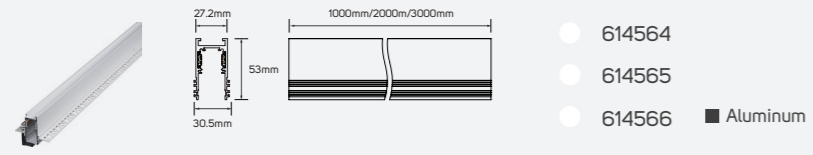

Pendant Magnetic Track Rail

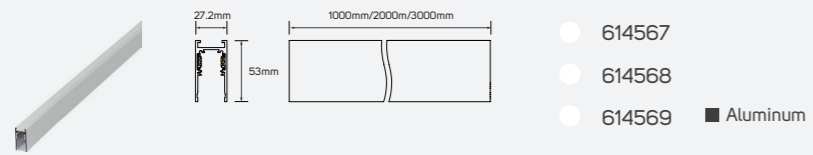

48V Magnetic Driver

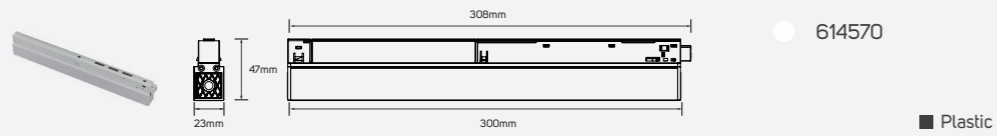

Recessed Horizontal Corner

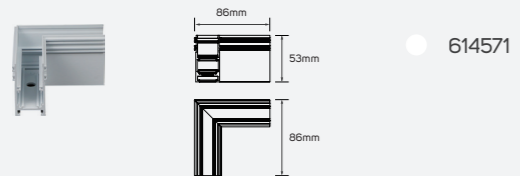

Recessed Inside Corner

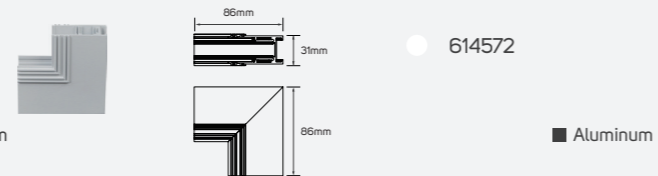

Surface Mounted Horizontal Corner

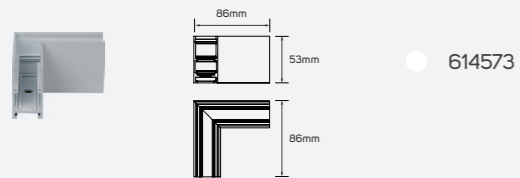

Surface Mounted Inside Corner

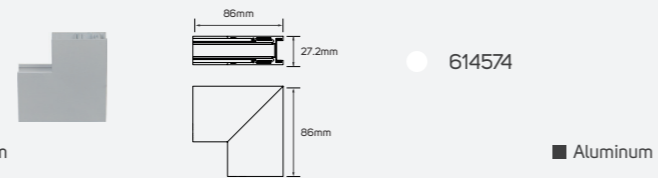

Flexible Corner Conductive Module

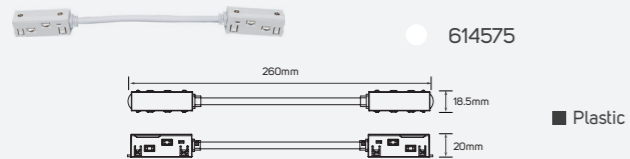

Direct Corner Conductive Module

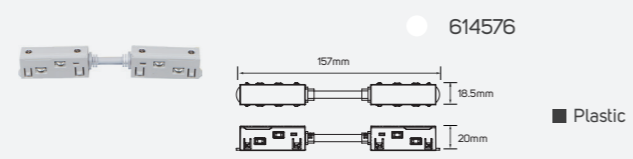

Cable Wire

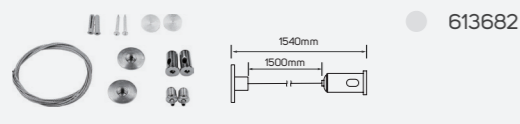

Cable Wire

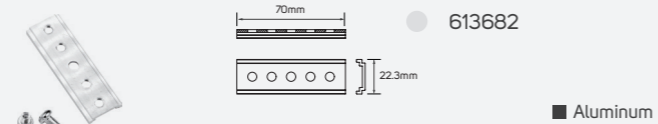



LED Adjustable Magnetic Track Linear Light (White Version)

Areas of Application

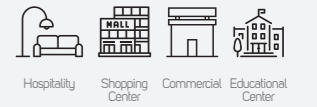

Rhythmic Joy

Technical Operating & Electrical Data

Operating Voltage	DC48V
IP Rating	IP20
Body Material	Aluminum
Rated CRI	90
Body Color	Sandy White
Beam Angle	30°
Mounting Type	Surface Mounted
Lifespan	30000H

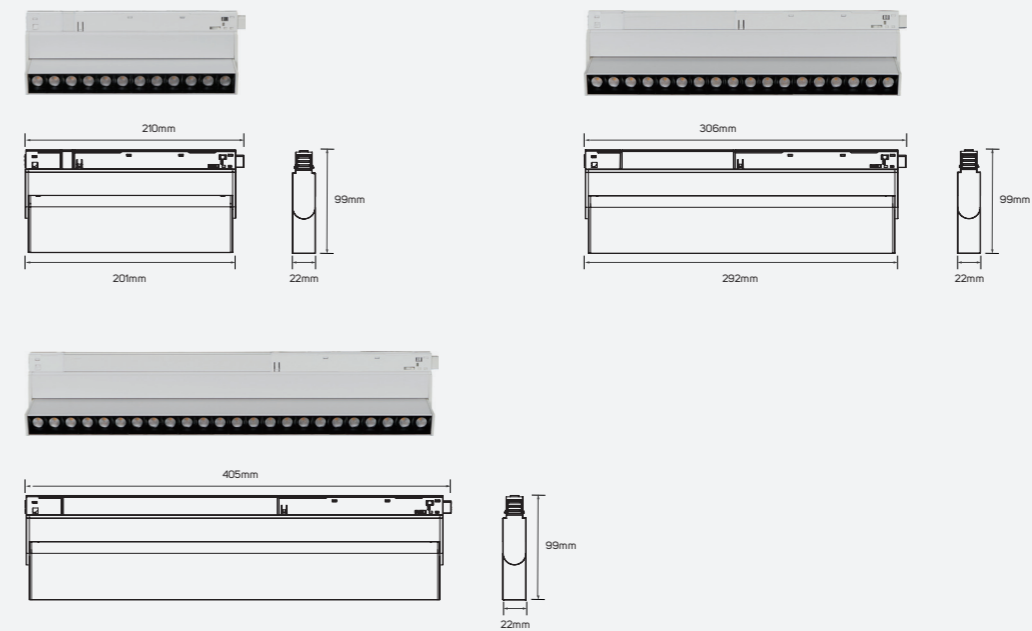

LED Adjustable Magnetic Track Linear Light (White Version)

PRODUCT INFORMATION

- Modern looking, neat luminaire offering comfortable, good quality lighting and can also work as a design element.
- Ideal lighting in the non-working areas of professional spaces such as offices, educational institutes, and also the welcoming areas and entrances of retail spaces.
- ILLUS LED MAGNETIC TRACK LINEAR Light gives the customer the flexibility to choose between 6 models based on their specific need with lumen package from 750 lm to 1850 lm.

BENEFITS

- Clean and uniform light.
- Multiple application use.
- Easy to install and maintain.

FEATURES

- High CRI>90.
- Efficacy up to 94 lm/w.
- Long life span 30,000 hrs.
- Operating voltage DC48 V.
- Non – dimmable.

Family Product List

Code No.	Model No.	Power	Lumen	Efficacy	CCT
614532	ILS8.5W30DMTL930WWW02	8.5W	750lm	88.24lm/W	3000K
614533	ILS8.5W30DMTL940NWW02	8.5W	800lm	94.12lm/W	4000K
614534	ILS15W30DMTL930WWW02	15W	1300lm	86.67lm/W	3000K
614535	ILS15W30DMTL940NWW02	15W	1370lm	91.33lm/W	4000K
614536	ILS20W30DMTL930WWW02	20W	1750lm	87.50lm/W	3000K
614537	ILS20W30DMTL940NWW02	20W	1850lm	92.50lm/W	4000K

Recessed Magnetic Track Rail

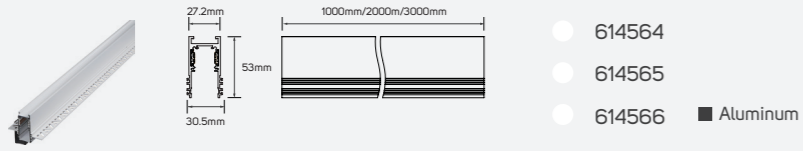

Pendant Magnetic Track Rail

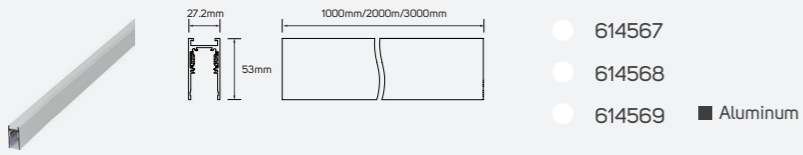

48V Magnetic Driver

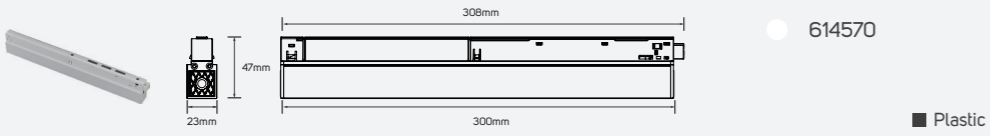

Recessed Horizontal Corner

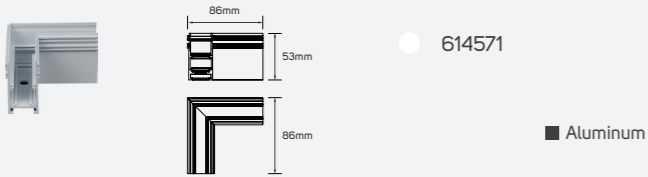

Recessed Inside Corner

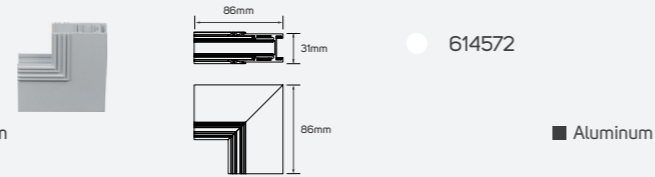

Surface Mounted Horizontal Corner

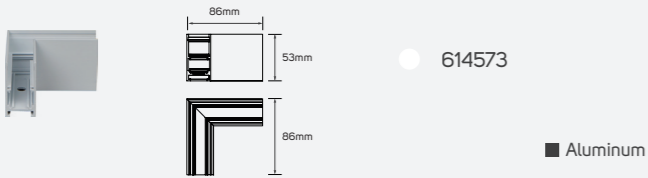

Surface Mounted Inside Corner

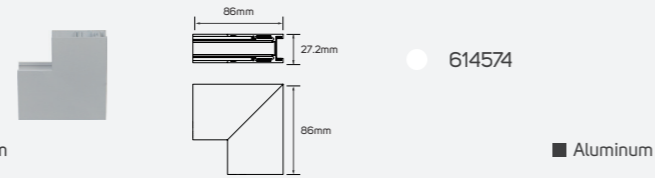

Flexible Corner Conductive Module

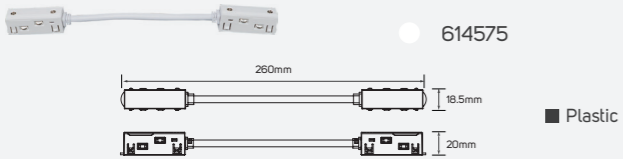

Direct Corner Conductive Module

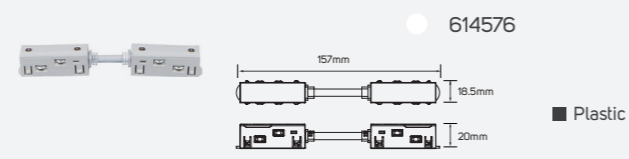

Cable Wire

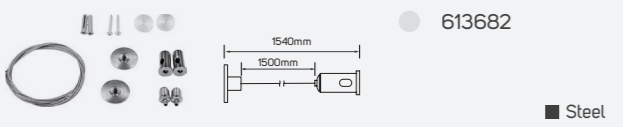

Cable Wire

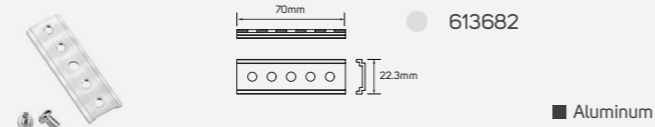



LED Magnetic Track Spot Light (White Version)

Areas of Application

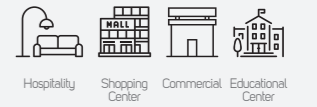

Planet

Technical Operating & Electrical Data

Operating Voltage	DC48V
IP Rating	IP20
Body Material	Aluminum
Rated CRI	90
Body Color	Sandy White
Beam Angle	24°
Mounting Type	Track Mounted
Lifespan	30000H

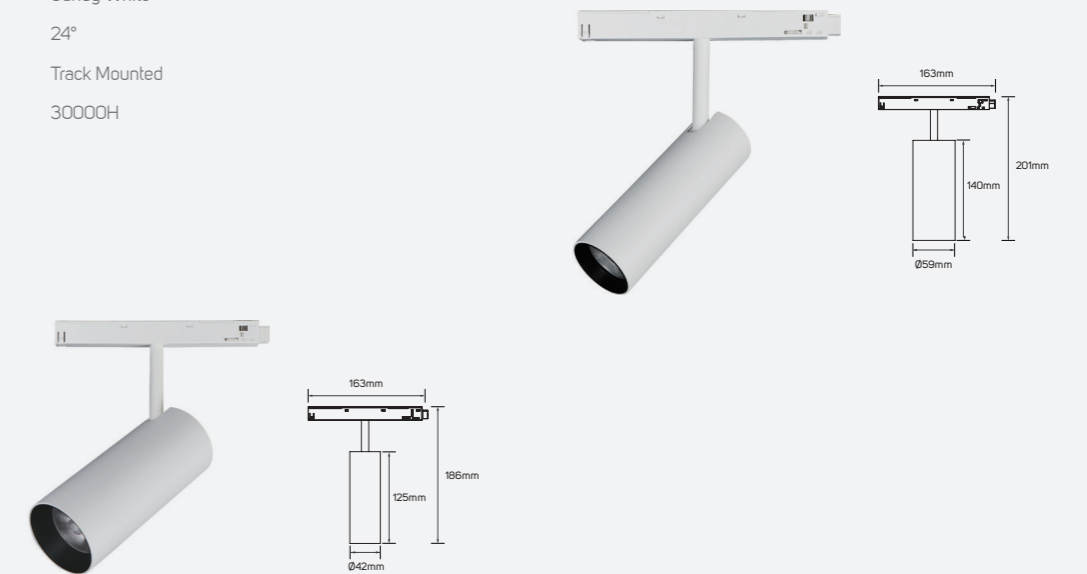

LED Magnetic Track Spot Light (White Version)

PRODUCT INFORMATION

- Modern looking, neat luminaire offering comfortable, good quality lighting and can also work as a design element.
- Ideal lighting in the non-working areas of professional spaces such as offices, educational institutes, and also the welcoming areas and entrances of retail spaces.
- ILLUS LED MAGNETIC TRACK SPOT Light gives the customer the flexibility to choose between 6 models based on their specific need with lumen package from 800 lm to 1450 lm.

BENEFITS

- Clean and uniform light.
- Multiple application use.
- Easy to install and maintain.

FEATURES

- High CRI>90.
- Efficacy up to 106 lm/w.
- Long life span 30,000 hrs.
- Operating voltage DC48 V.
- Non – dimmable.

Family Product List

Code No.	Model No.	Power	Lumen	Efficacy	CCT
614546	ILS8W24DMTSL930WWW01	8W	800lm	100lm/W	3000K
614547	ILS8W24DMTSL940NWW01	8W	850lm	106.25lm/W	4000K
614548	ILS12.5W24DMTSL930WWW01	12.5W	1150lm	92lm/W	3000K
614549	ILS12.5W24DMTSL940NWW01	12.5W	1220lm	97.60lm/W	4000K
614550	ILS16W24DMTSL930WWW01	16W	1350lm	84.38lm/W	3000K
614551	ILS16W24DMTSL940NWW01	16W	1450lm	90.63lm/W	4000K

Recessed Magnetic Track Rail

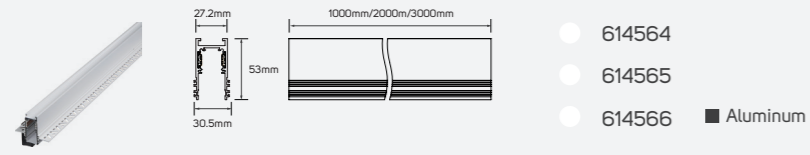

Pendant Magnetic Track Rail

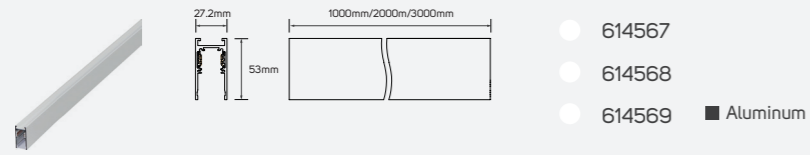

48V Magnetic Driver

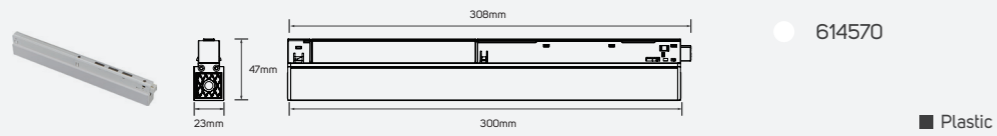

Recessed Horizontal Corner

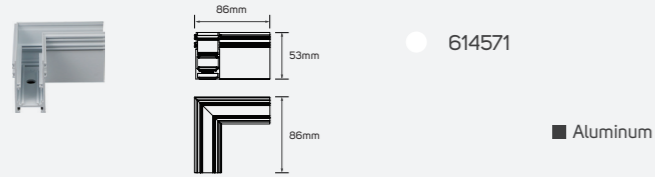

Recessed Inside Corner

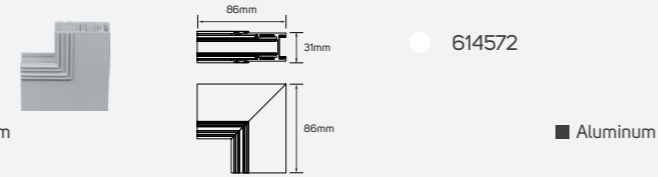

Surface Mounted Horizontal Corner

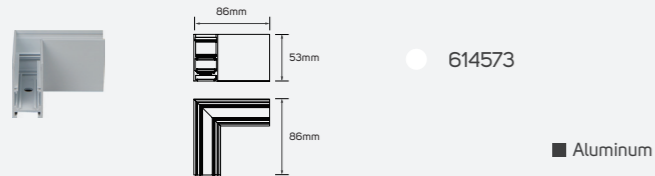

Surface Mounted Inside Corner

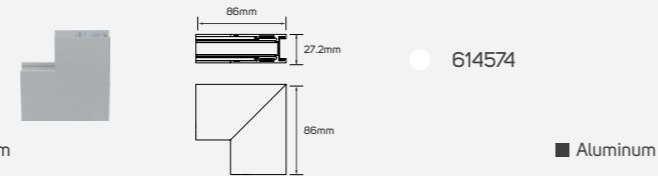

Flexible Corner Conductive Module

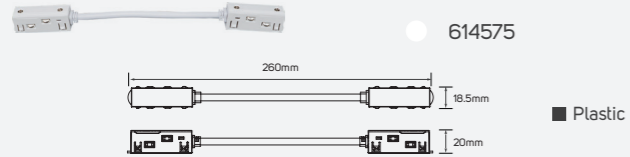

Direct Corner Conductive Module

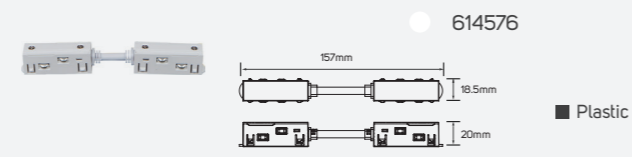

Cable Wire

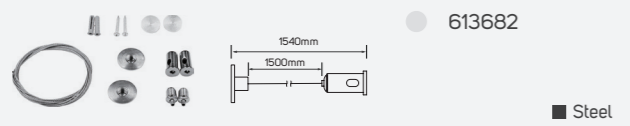

Cable Wire

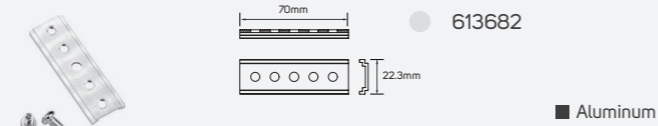



LED Magnetic Track Spot Light (White Version)

Areas of Application

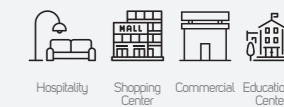

Glorya

Technical Operating & Electrical Data

Operating Voltage	DC48V
IP Rating	IP20
Body Material	Aluminum+Industrial Plastic
Rated CRI	90
Body Color	Sandy White
Beam Angle	24°
Mounting Type	Track Mounted
Lifespan	30000H

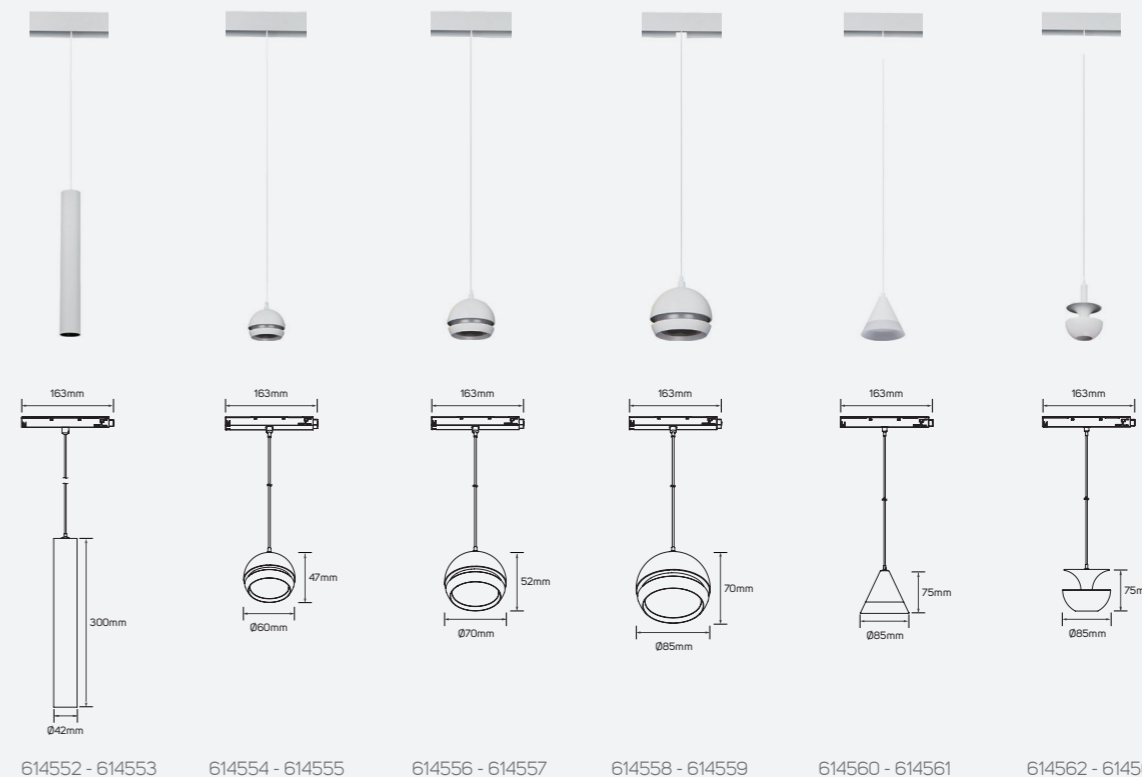

614552 - 614553 614554 - 614555 614556 - 614557 614558 - 614559 614560 - 614561 614562 - 614563

Family Product List

Code No.	Model No.	Power	Lumen	Efficacy	CCT
614552	ILS8.5W24DMTPL930WWW01	8.5W	850lm	100lm/W	3000K
614553	ILS8.5W24DMTPL940NWW01	8.5W	900lm	105.88lm/W	4000K
614554	ILS5W24DMTPL930WWW01	5W	450lm	90lm/W	3000K
614555	ILS5W24DMTPL940NWW01	5W	480lm	96lm/W	4000K
614556	ILS7W24DMTPL930WWW01	7W	650lm	92.86lm/W	3000K
614557	ILS7W24DMTPL940NWW01	7W	700lm	100lm/W	4000K
614558	ILS12W24DMTPL930WWW01	12W	950lm	79.17lm/W	3000K
614559	ILS12W24DMTPL940NWW01	12W	1050lm	87.50lm/W	4000K
614560	ILS4.5W24DMTPL930WWW01	4.5W	370lm	82.22lm/W	3000K
614561	ILS4.5W24DMTPL940NWW01	4.5W	450lm	100lm/W	4000K
614562	ILS4.5W24DMTPL930WWW02	4.5W	380lm	84.44lm/W	3000K
614563	ILS4.5W24DMTPL940NWW02	4.5W	400lm	88.89lm/W	4000K

LED Magnetic Track Spot Light (White Version)

PRODUCT INFORMATION

- Modern looking, neat luminaire offering comfortable, good quality lighting and can also work as a design element.
- Ideal lighting in the non-working areas of professional spaces such as offices, educational institutes, and also the welcoming areas and entrances of retail spaces.
- ILLUS LED MAGNETIC TRACK SPOT Light gives the customer the flexibility to choose between 12 models based on their specific need with lumen package from 370 lm to 1050 lm.

BENEFITS

- Clean and uniform light.
- Multiple application use.
- Easy to install and maintain.

FEATURES

- High CRI>90.
- Efficacy up to 106 lm/w.
- Long life span 30,000 hrs.
- Operating voltage DC48 V.
- Non - dimmable.

Recessed Magnetic Track Rail

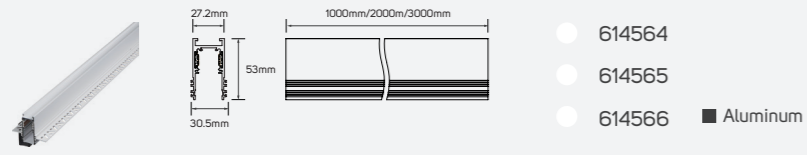

Pendant Magnetic Track Rail

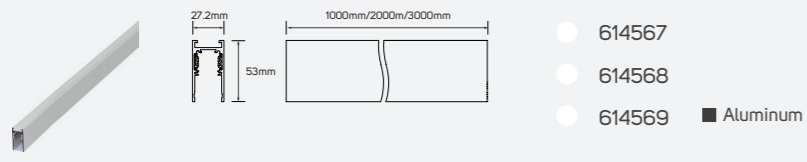

48V Magnetic Driver

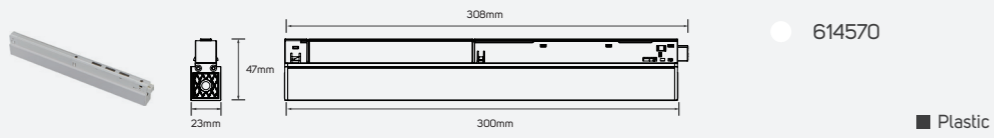

Recessed Horizontal Corner

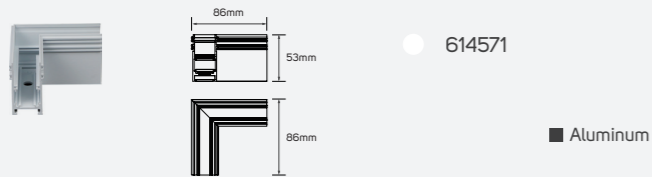

Recessed Inside Corner

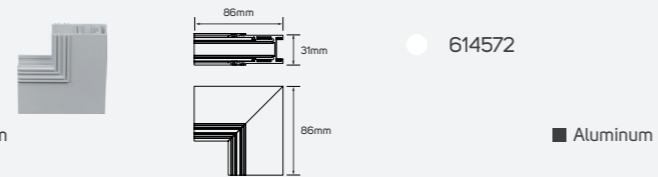

Surface Mounted Horizontal Corner

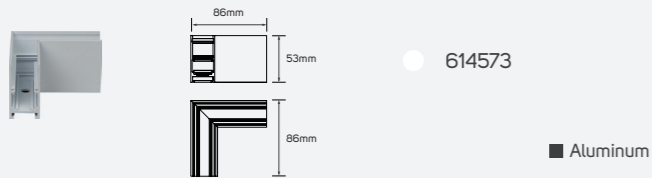

Surface Mounted Inside Corner

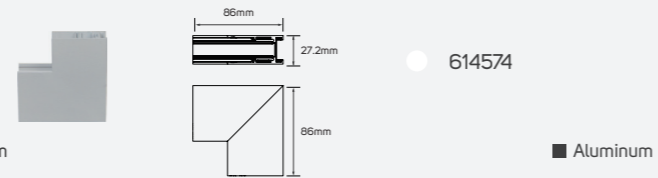

Flexible Corner Conductive Module

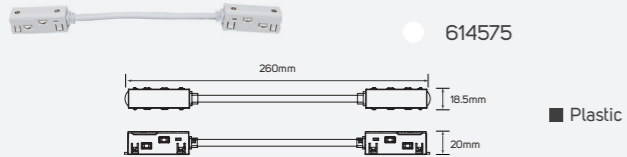

Direct Corner Conductive Module

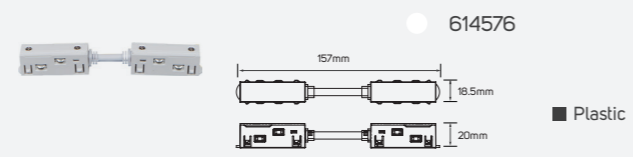

Cable Wire

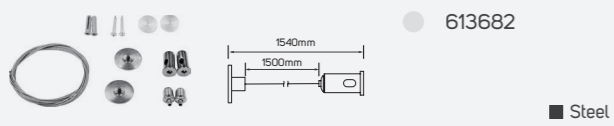

Cable Wire

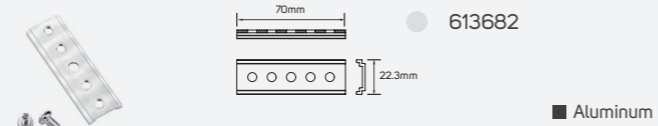



Magnetic Lights

■ LED Magnetic Lights





LED Magnetic Lights

PRODUCT INFORMATION

- Modern looking, neat luminaire offering comfortable, good quality lighting and can also work as a design element.
- Ideal lighting in the non-working areas of professional spaces such as offices, educational institutes, and also the welcoming areas and entrances of retail spaces.
- ILLUS LED MAGNETIC LIGHT gives the customer the flexibility to choose between 12 models based on their specific need with lumen package from 800lm to 3600lm.

BENEFITS

- Clean and uniform light.
- Multiple application use.
- Easy to install and maintain.

FEATURES

- High CRI>90.
- Efficacy up to 100lm/w.
- Long lifespan 30000H.
- Operating voltage DC48V.
- Non-Dimmable.

LED Magnetic Lights

Cosmos

Technical Operating & Electrical Data

Operating Voltage	DC48V
IP Rating	IP20
Body Material	Aluminum
Rated CRI	90
Body Color	Sandy Black
CCT	4000K
Dimming	Non-Dimmable
Lifespan	30000H

Areas of Application

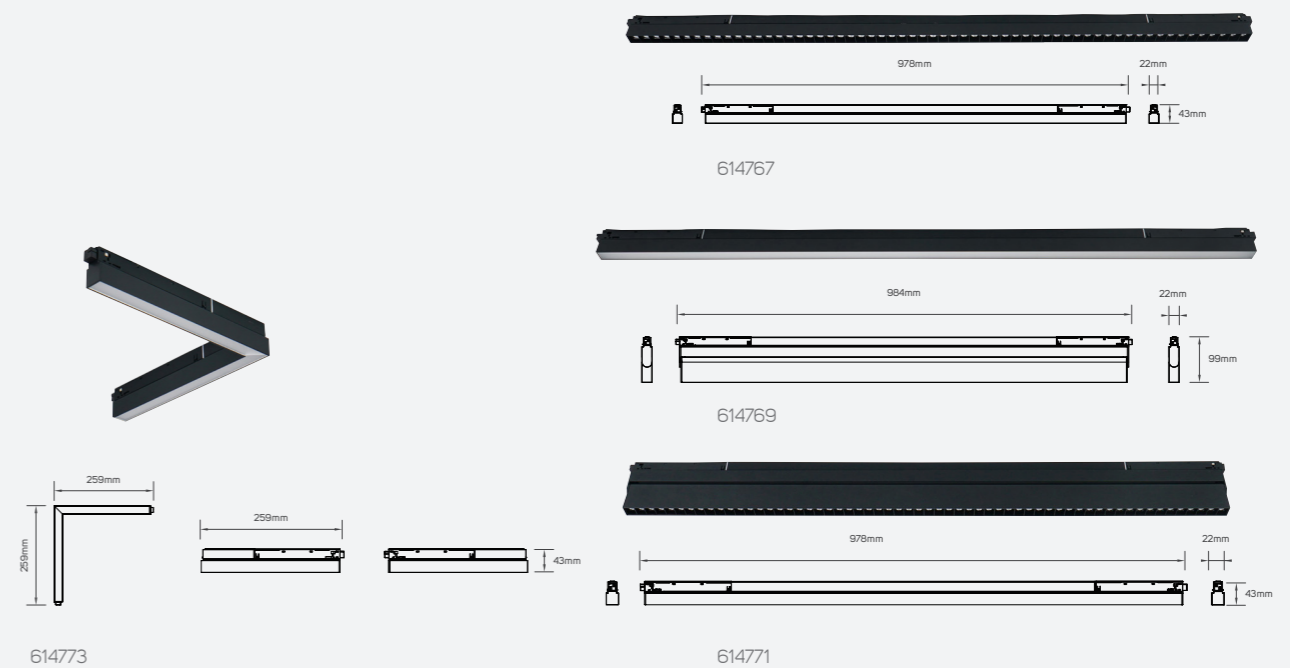
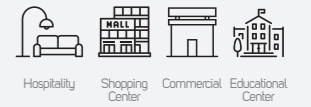

614773

614771

Family Product List

Code No.	Model No.	Power	Lumen	Efficacy	Beam Angle
● 614767	ILS38W28DRTL940NW01	38W	3600lm	94.74lm/W	30°
● 614769	ILS38W90DFMTL940NW01	38W	2950lm	77.63lm/W	90°
● 614771	ILS38W28DAMTL940NW01	38W	3600lm	94.74lm/W	30°
● 614773	ILS20W110DLMTL940NW01	20W	1600lm	80lm/W	90°

Cosmos

Technical Operating & Electrical Data

Operating Voltage	DC48V
IP Rating	IP20
Body Material	Aluminum
Rated CRI	90
Body Color	Sandy Black
CCT	4000K
Dimming	Non-Dimmable
Lifespan	30000H

Areas of Application

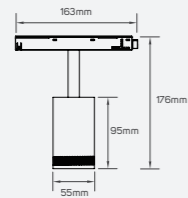
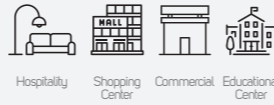

614775

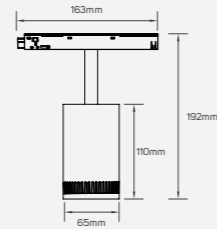

614777

Family Product List

Code No.	Model No.	Power	Lumen	Efficacy	Beam Angle
● 614775	ILS8WZMTL940NW01	8W	800lm	100lm/W	15°~55°
● 614777	ILS16WZMTL940NW01	16W	1600lm	100lm/W	15°~55°

Cosmos

Technical Operating & Electrical Data

Operating Voltage	DC48V
IP Rating	IP20
Body Material	Aluminum
Rated CRI	90
Body Color	Sandy White
CCT	4000K
Dimming	Non-Dimmable
Lifespan	30000H

Areas of Application

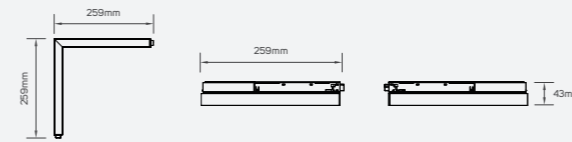
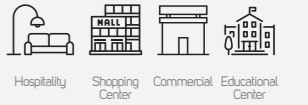

614761

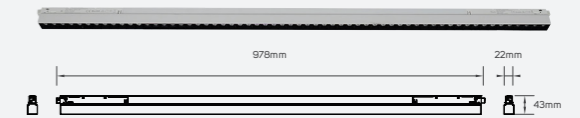

614755

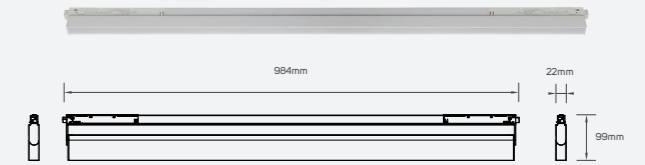

614757

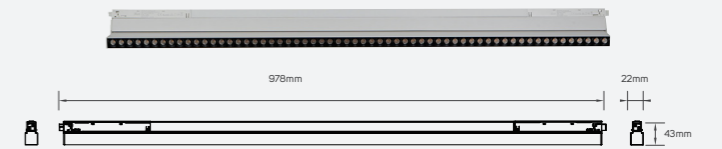

614759

Family Product List

Code No.	Model No.	Power	Lumen	Efficacy	Beam Angle
● 614755	ILS38W28DMTL940NW02	38W	3600lm	94.74lm/W	30°
● 614757	ILS38W90DFMTL940NW02	38W	2950lm	77.63lm/W	90°
● 614759	ILS38W28DAMTL940NW02	38W	3600lm	94.74lm/W	30°
● 614761	ILS20W110DLMTL940NW02	20W	1600lm	80lm/W	90°

Cosmos

Technical Operating & Electrical Data

Operating Voltage	DC48V
IP Rating	IP20
Body Material	Aluminum
Rated CRI	90
Body Color	Sandy White
CCT	4000K
Dimming	Non-Dimmable
Lifespan	30000H

Areas of Application

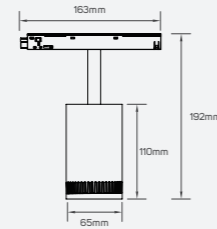
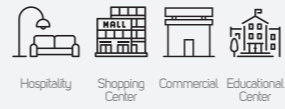

614765

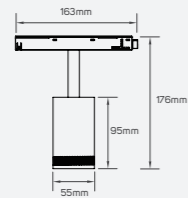

614763

Family Product List

Code No.	Model No.	Power	Lumen	Efficacy	Beam Angle
● 614763	ILS8WZMTL940NW02	8W	800lm	100lm/W	15°~55°
● 614765	ILS16WZMTL940NW02	16W	1600lm	100lm/W	15°~55°





LED Magnetic Lights

PRODUCT INFORMATION

- Modern looking, neat luminaire offering comfortable, good quality lighting and can also work as a design element.
- Ideal lighting in the non-working areas of professional spaces such as offices, educational institutes, and also the welcoming areas and entrances of retail spaces.
- ILLUS LED MAGNETIC ULTRA THIN Light gives the customer the flexibility to choose between 24 models based on their specific need with lumen package from 450lm to 1630lm.

BENEFITS

- Clean and uniform light.
- Multiple application use.
- Easy to install and maintain.

FEATURES

- High CRI>95.
- Efficacy up to 95lm/w.
- Long lifespan 30000H.
- Operating voltage DC24V.
- Non-Dimmable.

LED Magnetic Lights

Solis

Technical Operating & Electrical Data

Operating Voltage	DC24V
IP Rating	IP20
Body Material	Aluminum
Rated CRI	95
Body Color	Black
Dimming	Non-Dimmable
Lifespan	30000H

Areas of Application

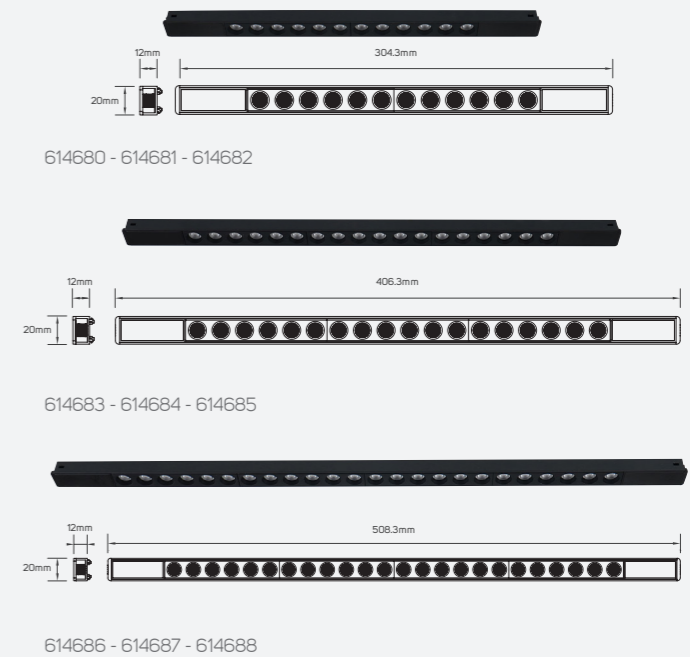
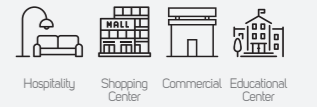

Family Product List

Code No.	Model No.	Power	Lumen	Efficacy	CCT	Beam Angle
● 614680	ILS9.5MSL930WWB01	9.5W	660lm	69.47lm/W	3000K	24°
● 614681	ILS9.5MSL940NWB01	9.5W	680lm	71.58lm/W	4000K	24°
● 614682	ILS9.5MSL965DLB01	9.5W	710lm	74.74lm/W	6500K	24°
● 614683	ILS13MSL930WWB01	13W	950lm	73.08lm/W	3000K	24°
● 614684	ILS13MSL940NWB01	13W	1000lm	76.92lm/W	4000K	24°
● 614685	ILS13MSL965DLB01	13W	1070lm	82.31lm/W	6500K	24°
● 614686	ILS17MSL930WWB01	17W	1250lm	73.53lm/W	3000K	24°
● 614687	ILS17MSL940NWB01	17W	1320lm	77.65lm/W	4000K	24°
● 614688	ILS17MSL965DLB01	17W	1400lm	82.35lm/W	6500K	24°

Embedded Track Rail

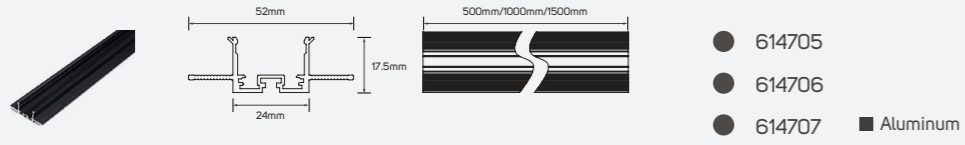

Recessed Track Rail

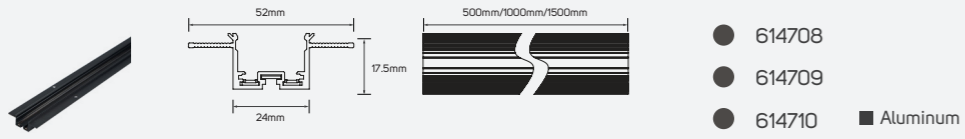

Surface Mounted Track Rail

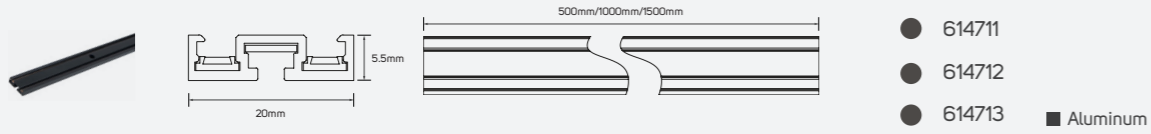

Ultra Thin Surface Mounted Track Rail

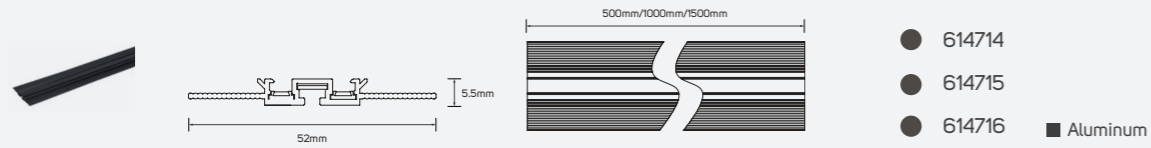

Connector

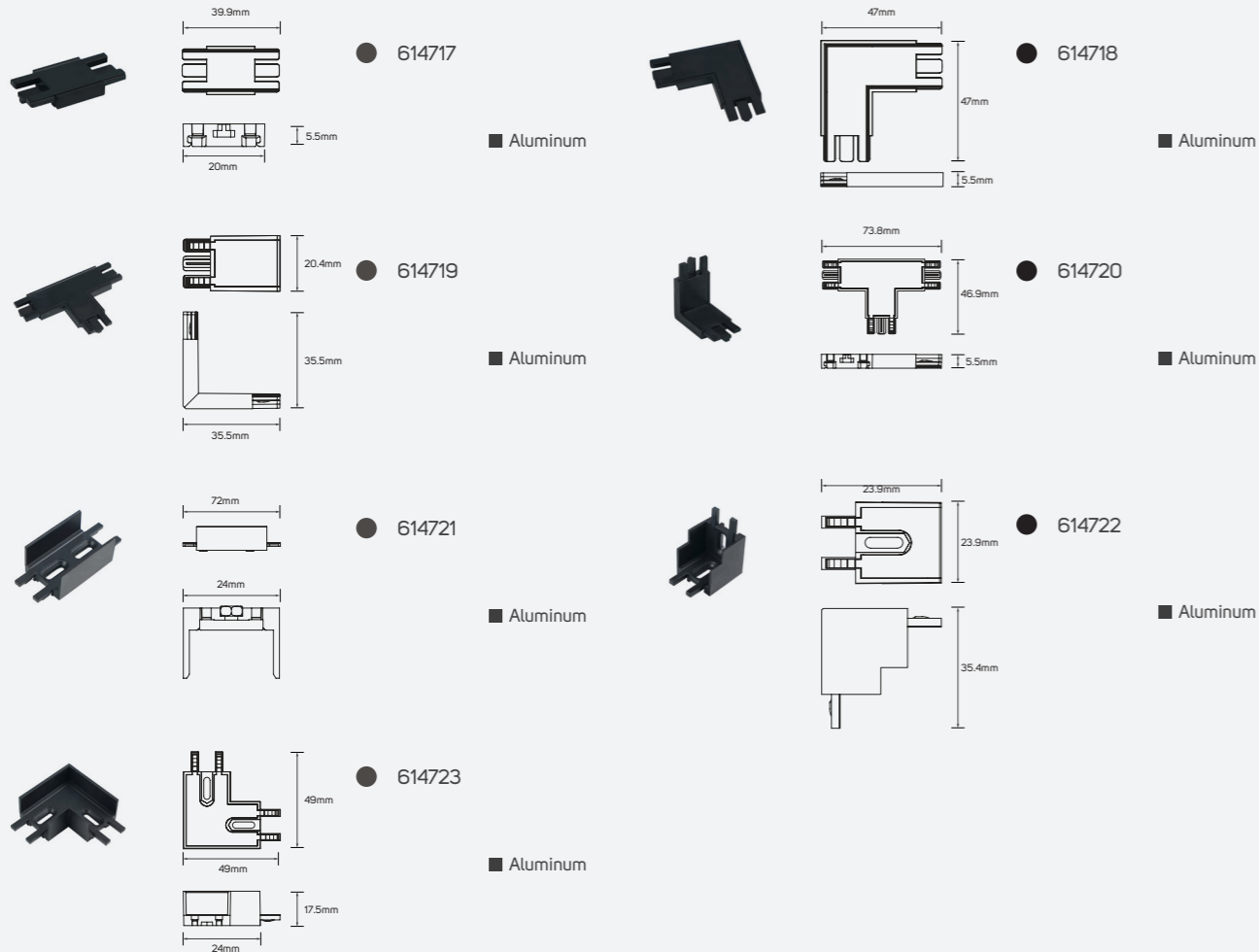

LED Magnetic Lights

Solis

Technical Operating & Electrical Data

Operating Voltage	DC24V
IP Rating	IP20
Body Material	Aluminum
Rated CRI	95
Body Color	Black
Dimming	Non-Dimmable
Lifespan	30000H

Areas of Application

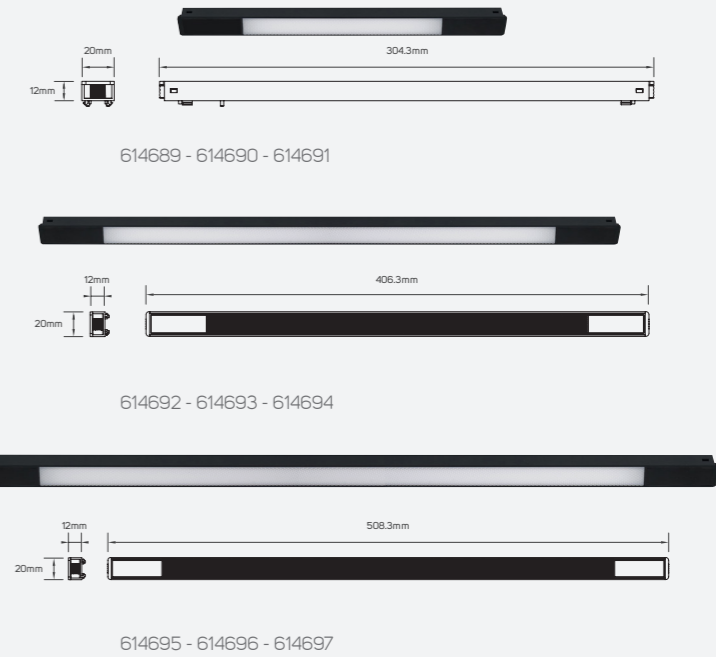

Family Product List

Code No.	Model No.	Power	Lumen	Efficacy	CCT	Beam Angle
● 614689	ILS10MLL930WWB01	10W	800lm	80lm/W	3000K	110°
● 614690	ILS10MLL940NWB01	10W	820lm	82lm/W	4000K	110°
● 614691	ILS10MLL965DLB01	10W	850lm	85lm/W	6500K	110°
● 614692	ILS13MLL930WWB01	13W	1100lm	84.62lm/W	3000K	110°
● 614693	ILS13MLL940NWB01	13W	1150lm	88.46lm/W	4000K	110°
● 614694	ILS13MLL965DLB01	13W	1230lm	94.62lm/W	6500K	110°
● 614695	ILS17.5MLL930WWB01	17.5W	1480lm	84.57lm/W	3000K	110°
● 614696	ILS17.5MLL940NWB01	17.5W	1550lm	88.57lm/W	4000K	110°
● 614697	ILS17.5MLL965DLB01	17.5W	1630lm	93.14lm/W	6500K	110°

Solis

Technical Operating & Electrical Data

Operating Voltage	DC24V
IP Rating	IP20
Body Material	Aluminum
Rated CRI	95
Body Color	Black
Dimming	Non-Dimmable
Lifespan	30000H

Areas of Application

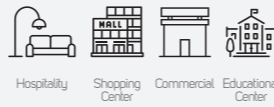

614701 - 614702 - 614703

Family Product List

Code No.	Model No.	Power	Lumen	Efficacy	CCT	Beam Angle
● 614701	ILS9.5AMSL930WWB01	9.5W	690lm	72.63lm/W	3000K	24°
● 614702	ILS9.5AMSL940NWB01	9.5W	720lm	75.79lm/W	4000K	24°
● 614703	ILS9.5AMSL965DLB01	9.5W	750lm	78.95lm/W	6500K	24°

Solis

Technical Operating & Electrical Data

Operating Voltage	DC24V
IP Rating	IP20
Body Material	Aluminum
Rated CRI	95
Body Color	Black
Dimming	Non-Dimmable
Lifespan	30000H

Areas of Application

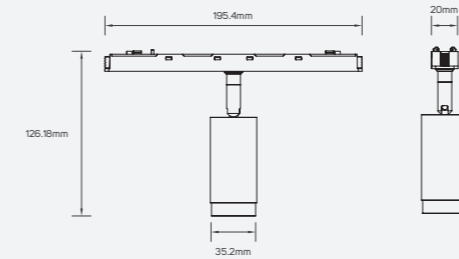
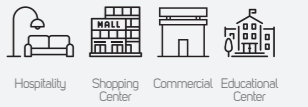

614698 - 614699 - 614700

Family Product List

Code No.	Model No.	Power	Lumen	Efficacy	CCT	Beam Angle
● 614698	ILS6MTL930WWB01	6W	450lm	75lm/W	3000K	36°
● 614699	ILS6MTL940NWB01	6W	470lm	78.33lm/W	4000K	36°
● 614700	ILS6MTL965DLB01	6W	500lm	83.33lm/W	6500K	36°

Embedded Track Rail

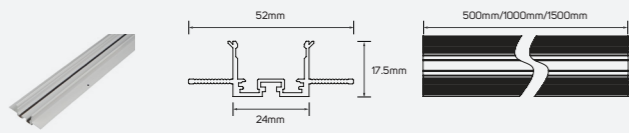

- 614817
- 614818
- 614819
- Aluminum

Recessed Track Rail

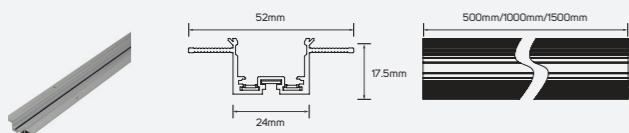

- 614820
- 614821
- 614822
- Aluminum

Surface Mounted Track Rail

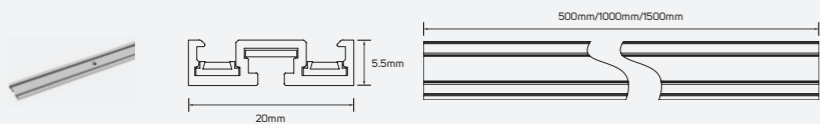

- 614823
- 614824
- 614825
- Aluminum

Ultra Thin Track Light

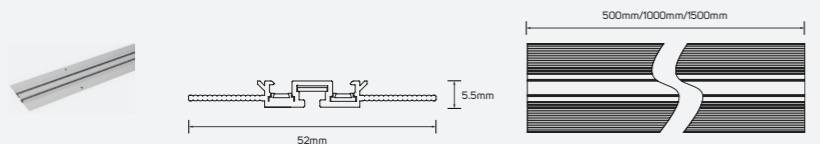

- 614826
- 614827
- 614828
- Aluminum

Connector

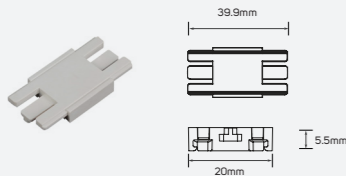

- 614829
- Aluminum

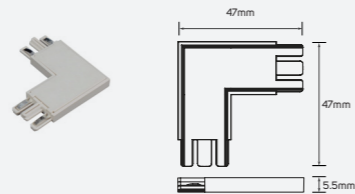

- 614830
- Aluminum

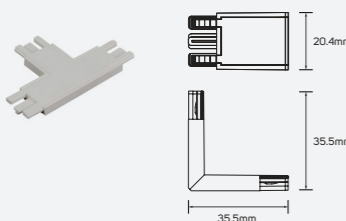

- 614831
- Aluminum

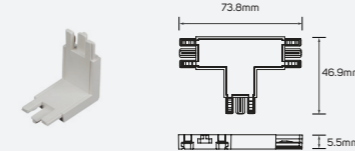

- 614832
- Aluminum

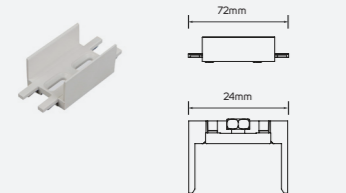

- 614833
- Aluminum

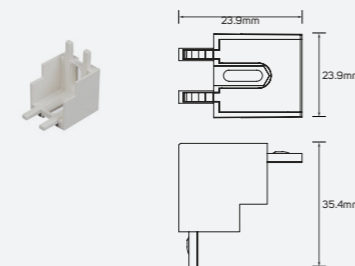

- 614834
- Aluminum

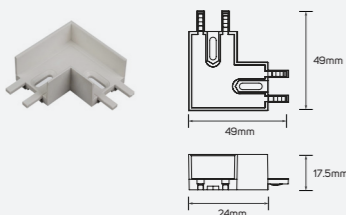

- 614835
- Aluminum

LED Magnetic Lights

Solis

Technical Operating & Electrical Data

Operating Voltage	DC24V
IP Rating	IP20
Body Material	Aluminum
Rated CRI	95
Body Color	White
Dimming	Non-Dimmable
Lifespan	30000H

Areas of Application

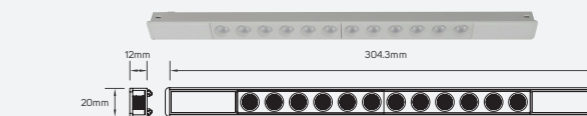
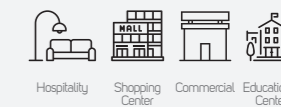

614800 - 614801 - 614861

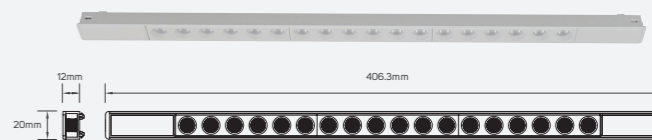

614802 - 614803 - 614862

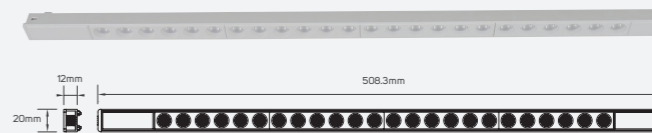

614804 - 614805 - 614863

Family Product List

Code No.	Model No.	Power	Lumen	Efficacy	CCT	Beam Angle
● 614800	ILS9.5MSL930WWB02	9.5W	660lm	69.47lm/W	3000K	24°
● 614801	ILS9.5MSL940NWB02	9.5W	680lm	71.58lm/W	4000K	24°
● 614861	ILS9.5MSL965DLB02	9.5W	710lm	74.74lm/W	6500K	24°
● 614802	ILS13MSL930WWB02	13W	950lm	73.08lm/W	3000K	24°
● 614803	ILS13MSL940NWB02	13W	1000lm	76.92lm/W	4000K	24°
● 614862	ILS13MSL965DLB02	13W	1070lm	82.31lm/W	6500K	24°
● 614804	ILS17MSL930WWB02	17W	1250lm	73.53lm/W	3000K	24°
● 614805	ILS17MSL940NWB02	17W	1320lm	77.65lm/W	4000K	24°
● 614863	ILS17MSL965DLB02	17W	1400lm	82.35lm/W	6500K	24°

Solis

Technical Operating & Electrical Data

Operating Voltage	DC24V
IP Rating	IP20
Body Material	Aluminum
Rated CRI	95
Body Color	White
Dimming	Non-Dimmable
Lifespan	30000H

Areas of Application

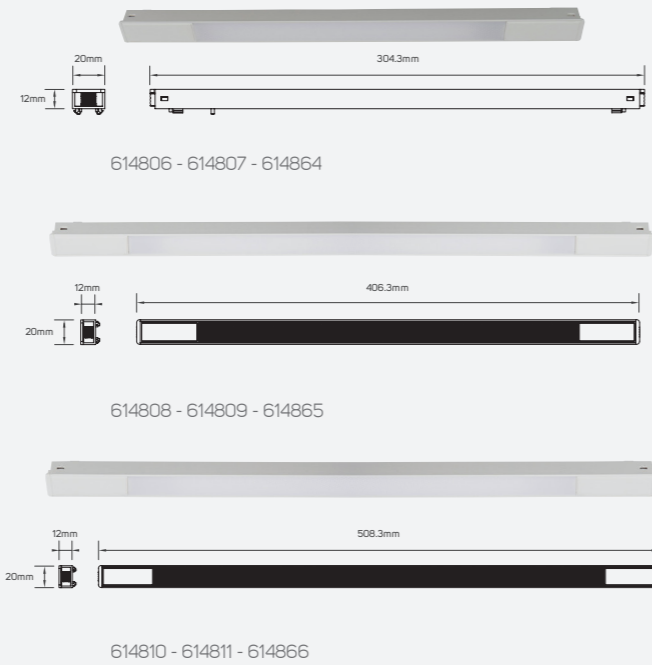
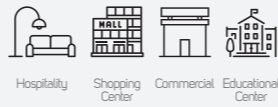

Family Product List

Code No.	Model No.	Power	Lumen	Efficacy	CCT	Beam Angle
614806	ILS10MLL930WWB02	10W	800lm	80lm/W	3000K	110°
614807	ILS10MLL940NWB02	10W	820lm	82lm/W	4000K	110°
614864	ILS10MLL965DLB02	10W	850lm	85lm/W	6500K	110°
614808	ILS13MLL930WWB02	13W	1100lm	84.62lm/W	3000K	110°
614809	ILS13MLL940NWB02	13W	1150lm	88.46lm/W	4000K	110°
614865	ILS13MLL965DLB02	13W	1230lm	94.62lm/W	6500K	110°
614810	ILS17.5MLL930WWB02	17.5W	1480lm	84.57lm/W	3000K	110°
614811	ILS17.5MLL940NWB02	17.5W	1550lm	88.57lm/W	4000K	110°
614866	ILS17.5MLL965DLB02	17.5W	1630lm	93.14lm/W	6500K	110°

Solis

Technical Operating & Electrical Data

Operating Voltage	DC24V
IP Rating	IP20
Body Material	Aluminum
Rated CRI	95
Body Color	White
Dimming	Non-Dimmable
Lifespan	30000H

Areas of Application

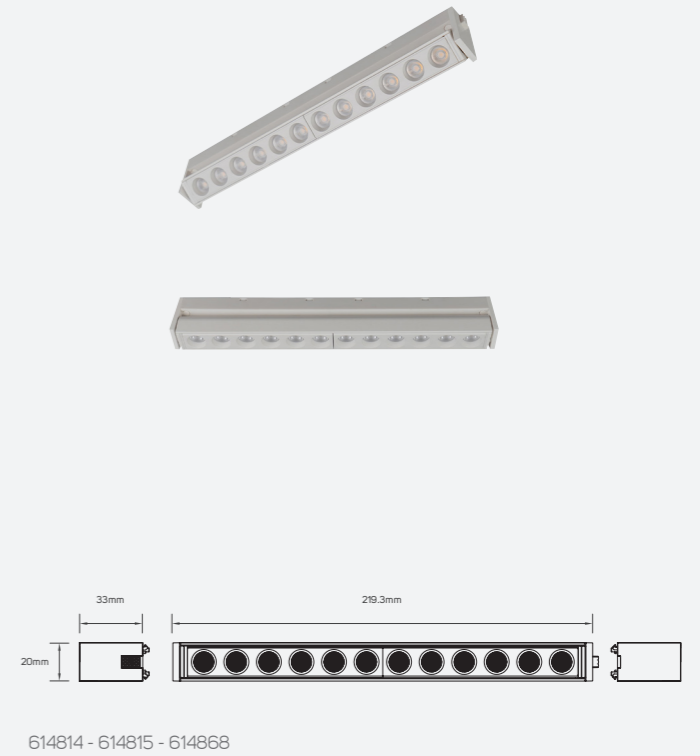
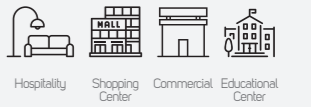

Family Product List

Code No.	Model No.	Power	Lumen	Efficacy	CCT	Beam Angle
614814	ILS9.5AMSL930WWB02	9.5W	690lm	72.63lm/W	3000K	24°
614815	ILS9.5AMSL940NWB02	9.5W	720lm	75.79lm/W	4000K	24°
614868	ILS9.5AMSL965DLB02	9.5W	750lm	78.95lm/W	6500K	24°

Solis

Technical Operating & Electrical Data

Operating Voltage	DC24V
IP Rating	IP20
Body Material	Aluminum
Rated CRI	95
Body Color	White
Dimming	Non-Dimmable
Lifespan	30000H

Areas of Application

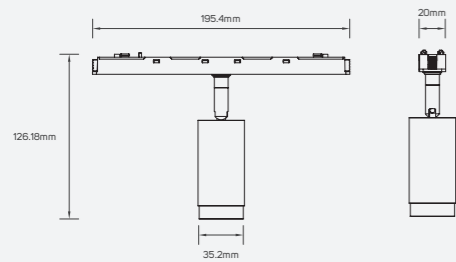
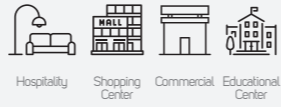

614812 - 614813 - 614867

Family Product List

Code No.	Model No.	Power	Lumen	Efficacy	CCT	Beam Angle
614812	ILS6MTL930WWB02	6W	450lm	75lm/W	3000K	36°
614813	ILS6MTL940NWB02	6W	470lm	78.33lm/W	4000K	36°
614867	ILS6MTL965DLB02	6W	500lm	83.33lm/W	6500K	36°





LED Magnetic Lights

Areas of Application

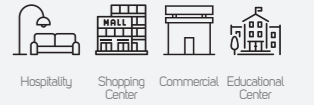

Roman Romance

Technical Operating & Electrical Data

Operating Voltage	DC48V
IP Rating	IP20
Body Material	Aluminum
Rated CRI	90
Body Color	Sandy Black
Beam Angle	30°
Mounting Type	Surface Mounted
Lifespan	30000H

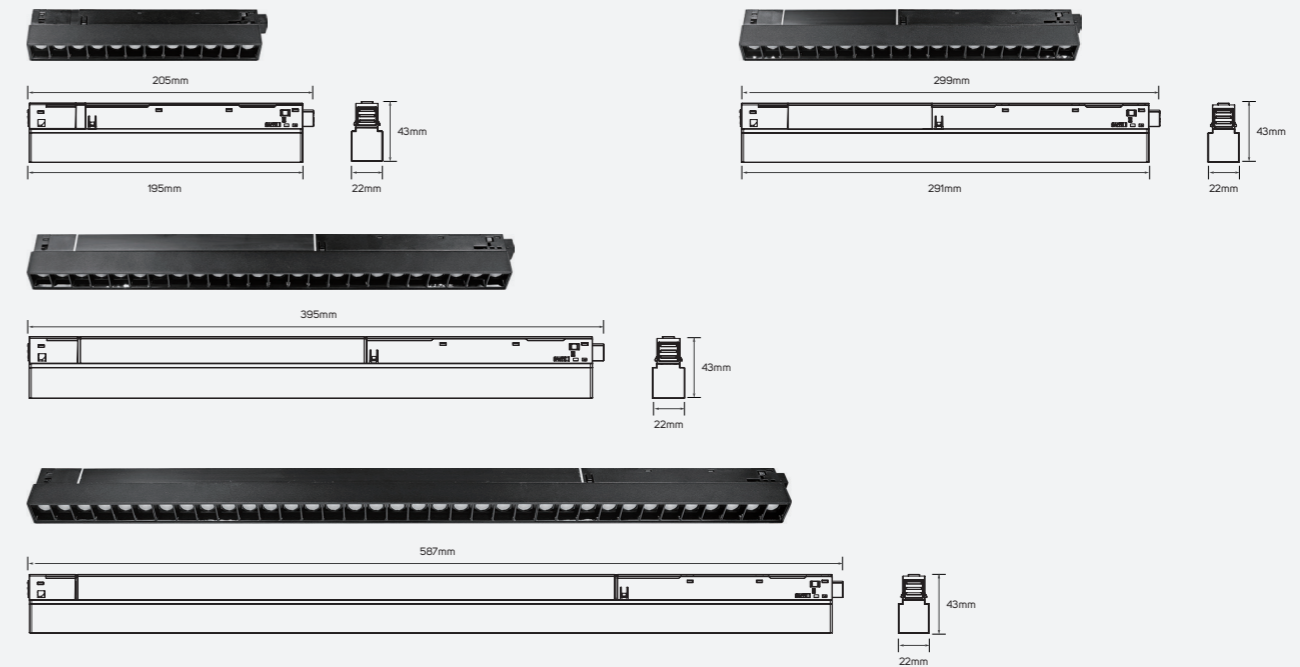

LED Magnetic Lights

PRODUCT INFORMATION

- Modern looking, neat luminaire offering comfortable, good quality lighting and can also work as a design element.
- Ideal lighting in the non-working areas of professional spaces such as offices, educational institutes, and also the welcoming areas and entrances of retail spaces.
- ILLUS LED MAGNETIC TRACK LINEAR Light gives the customer the flexibility to choose between 8 models based on their specific need with lumen package from 750 lm to 2250 lm.

BENEFITS

- Clean and uniform light.
- Multiple application use.
- Easy to install and maintain.

FEATURES

- High CRI>90.
- Efficacy up to 98 lm/w.
- Long life span 30,000 hrs.
- Operating voltage DC48 V.
- Non – dimmable.

Family Product List

Code No.	Model No.	Power	Lumen	Efficacy	CCT
● 613629	ILS9W36DMTL930WW01	8.5W	750lm	88.24lm/W	3000K
● 613630	ILS9W36DMTL940NW01	8.5W	800lm	94.12lm/W	4000K
● 613631	ILS15W36DMTL930WW01	14.5W	1300lm	89.66lm/W	3000K
● 613632	ILS15W36DMTL940NW01	14.5W	1370lm	94.48lm/W	4000K
● 613633	ILS20W36DMTL930WW01	20W	1650lm	82.50lm/W	3000K
● 613634	ILS20W36DMTL940NW01	20W	1750lm	87.50lm/W	4000K
● 613635	ILS24W110DMTL930WW01	23W	2050lm	89.13lm/W	3000K
● 613636	ILS24W110DMTL940NW01	23W	2250lm	97.83lm/W	4000K

Recessed Magnetic Track Rail

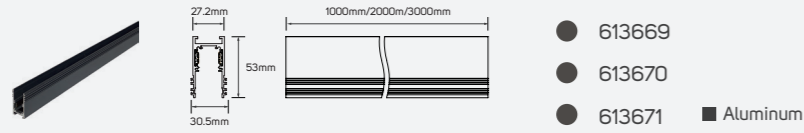

Pendant Magnetic Track Rail

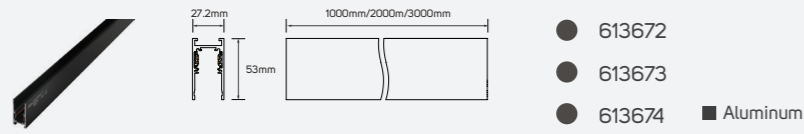

48V Magnetic Driver

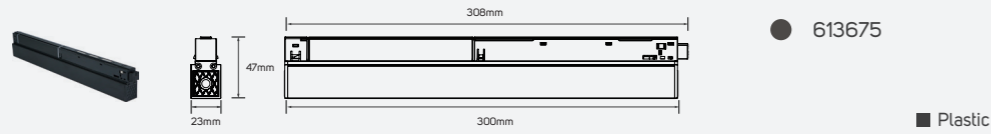

Recessed Horizontal Corner

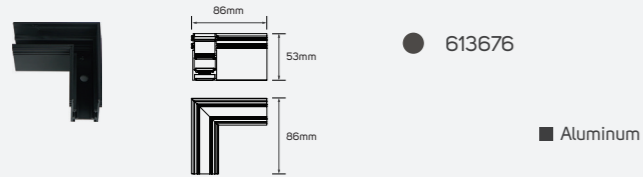

Recessed Inside Corner

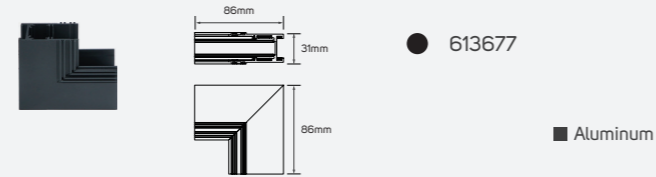

Surface Mounted Horizontal Corner

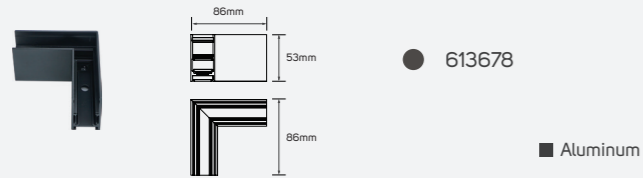

Surface Mounted Inside Corner

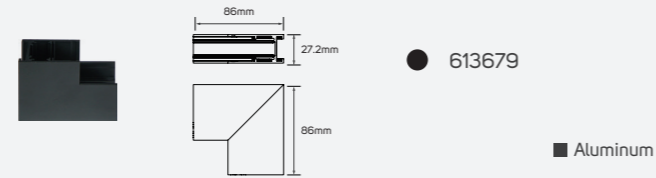

Flexible Corner Conductive Module

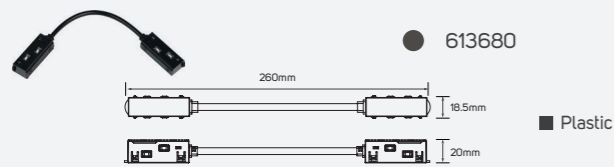

Direct Corner Conductive Module

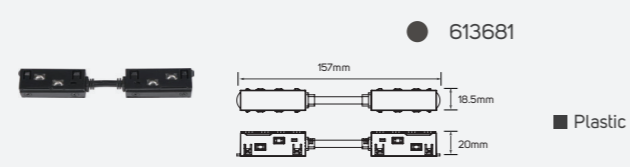

Cable Wire

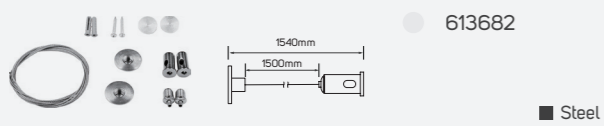

Cable Wire

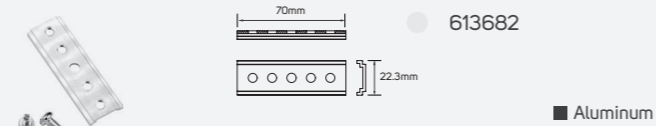

LED Magnetic Lights

Roman Romance

Technical Operating & Electrical Data

Operating Voltage	DC48V
IP Rating	IP20
Body Material	Aluminum
Rated CRI	90
Body Color	Sandy White
Beam Angle	30°
Mounting Type	Surface Mounted
Lifespan	30000H

Areas of Application

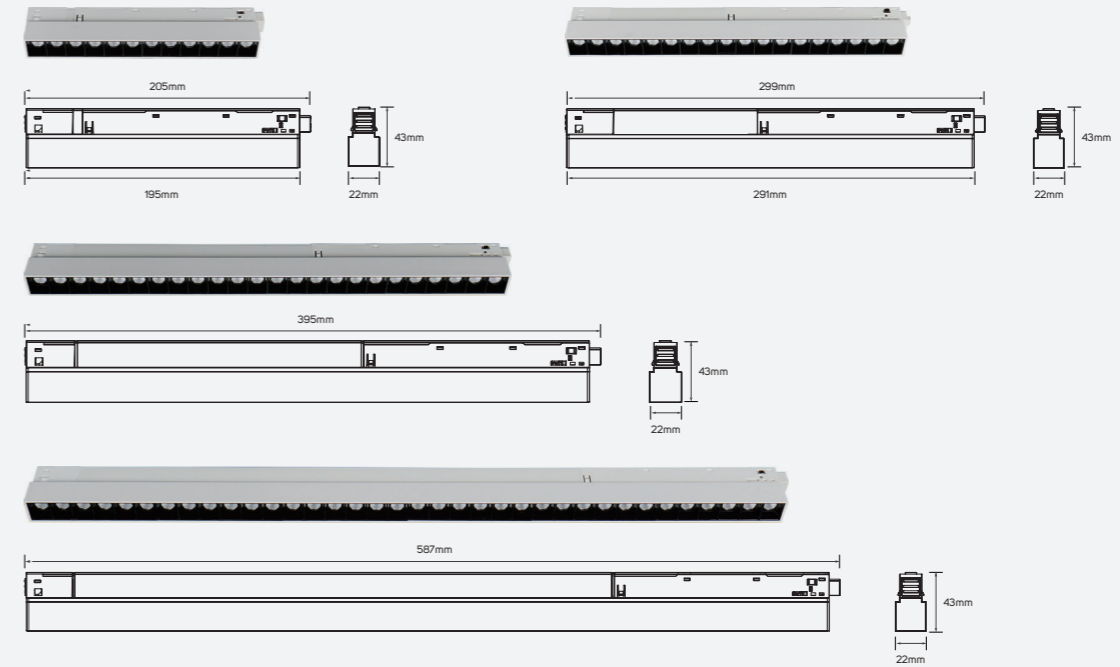

Family Product List

Code No.	Model No.	Power	Lumen	Efficacy	CCT
614524	ILS8.5W30DMTL930WWW01	8.5W	750lm	88.24lm/W	3000K
614525	ILS8.5W30DMTL940NWW01	8.5W	800lm	94.12lm/W	4000K
614526	ILS14.5W30DMTL930WWW01	14.5W	1300lm	89.66lm/W	3000K
614527	ILS14.5W30DMTL940NWW01	14.5W	1370lm	94.48lm/W	4000K
614528	ILS20W30DMTL930WWW01	20W	1650lm	82.50lm/W	3000K
614529	ILS20W30DMTL940NWW01	20W	1750lm	87.50lm/W	4000K
614530	ILS23W30DMTL930WWW01	23W	2050lm	89.13lm/W	3000K
614531	ILS23W30DMTL940NWW01	23W	2250lm	97.83lm/W	4000K

Recessed Magnetic Track Rail

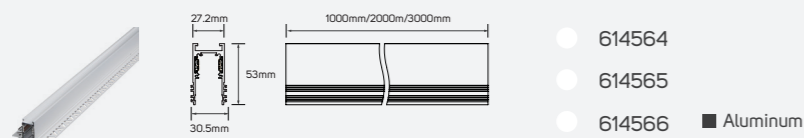

Pendant Magnetic Track Rail

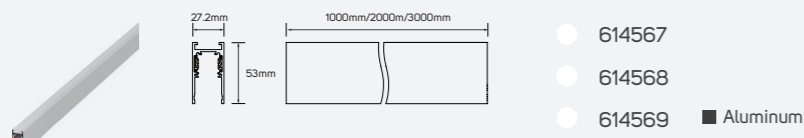

48V Magnetic Driver

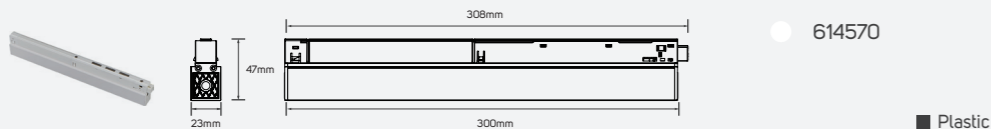

Recessed Horizontal Corner

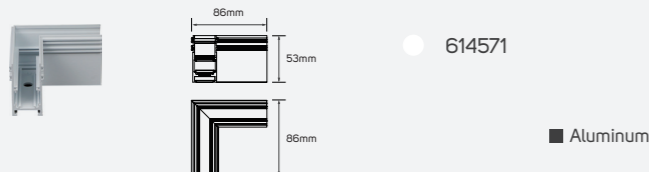

Recessed Inside Corner

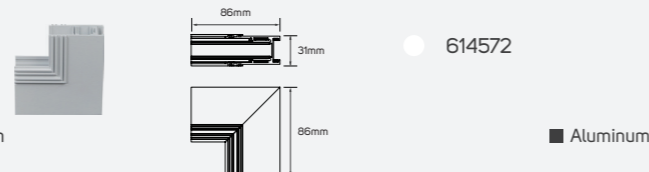

Surface Mounted Horizontal Corner

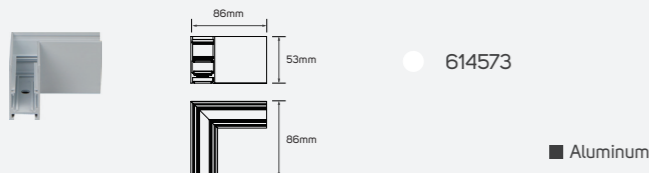

Surface Mounted Inside Corner

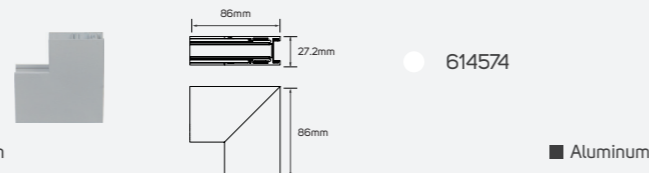

Flexible Corner Conductive Module

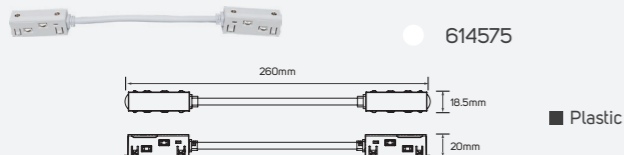

Direct Corner Conductive Module

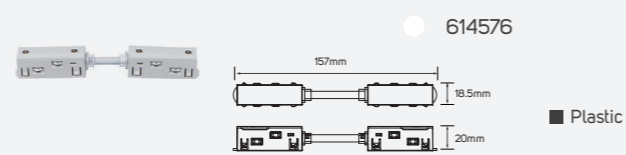

Cable Wire

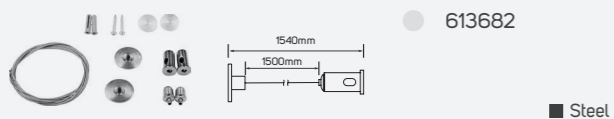

Cable Wire

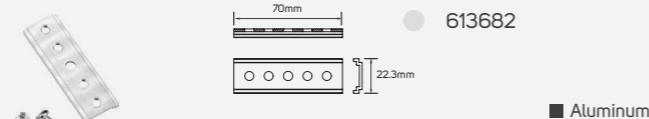

LED Magnetic Lights

Roman Romance

Technical Operating & Electrical Data

Operating Voltage	DC48V
IP Rating	IP20
Body Material	Aluminum
Rated CRI	90
Body Color	Sandy Black
Beam Angle	30°
Mounting Type	Surface Mounted
Lifespan	30000H

Areas of Application

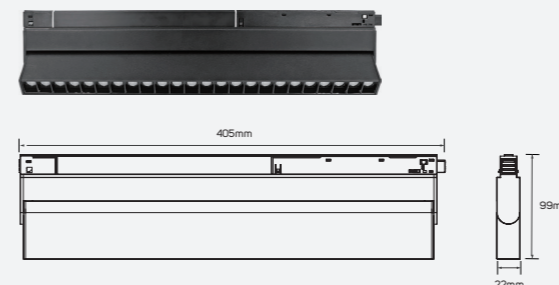
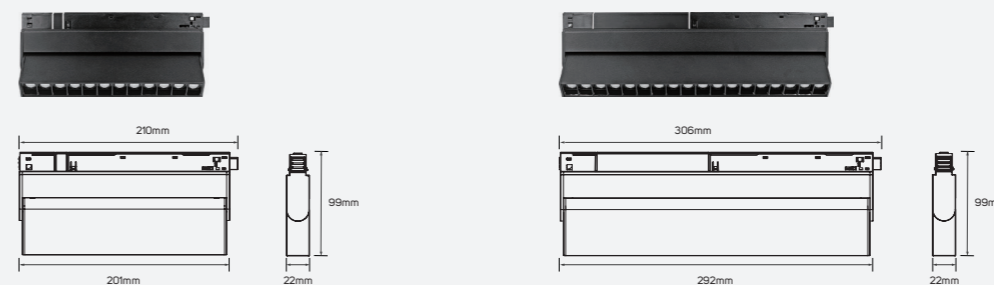
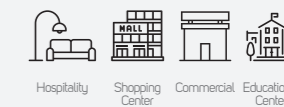

Family Product List

Code No.	Model No.	Power	Lumen	Efficacy	CCT
● 613637	ILS9W36DMTL930WW02	8.5W	750lm	88.24lm/W	3000K
● 613638	ILS9W36DMTL940NW02	8.5W	800lm	94.12lm/W	4000K
● 613639	ILS15W36DMTL930WW02	15W	1300lm	86.67lm/W	3000K
● 613640	ILS15W36DMTL940NW02	15W	1370lm	91.33lm/W	4000K
● 613641	ILS20W36DMTL930WW02	20W	1750lm	87.50lm/W	3000K
● 613642	ILS20W36DMTL940NW02	20W	1850lm	92.50lm/W	4000K

Recessed Magnetic Track Rail

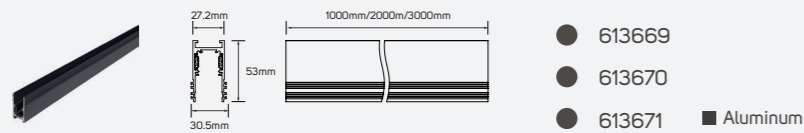

Pendant Magnetic Track Rail

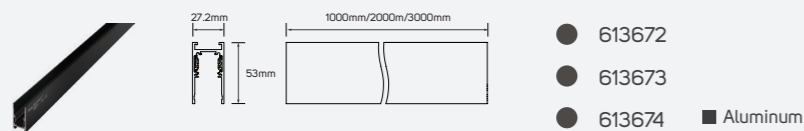

48V Magnetic Driver

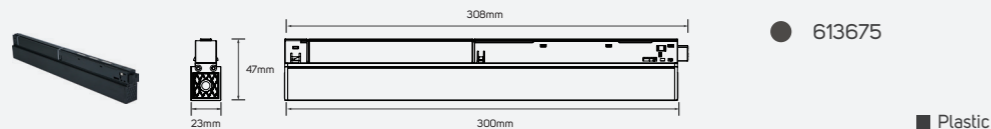

Recessed Horizontal Corner

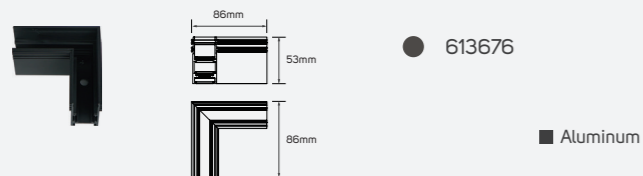

Recessed Inside Corner

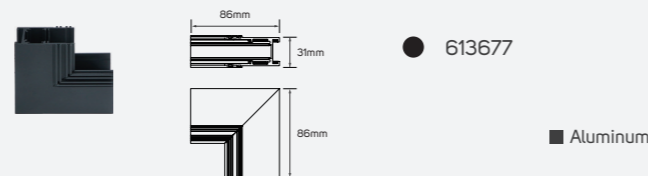

Surface Mounted Horizontal Corner

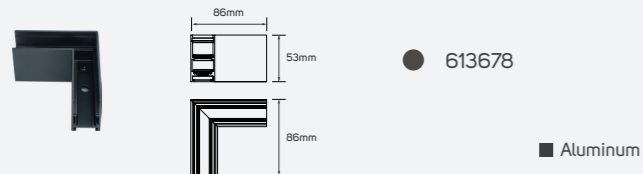

Surface Mounted Inside Corner

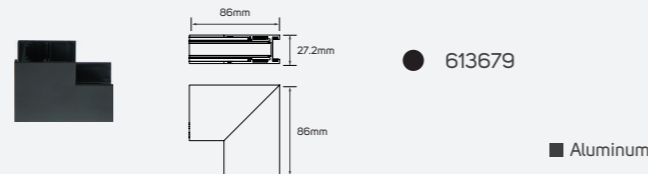

Flexible Corner Conductive Module

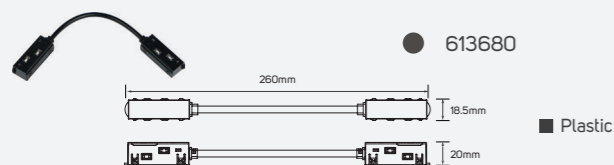

Direct Corner Conductive Module

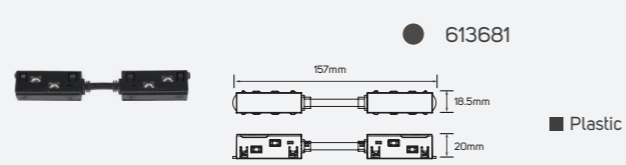

Cable Wire

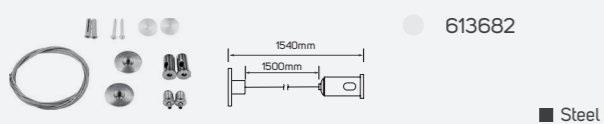

Cable Wire

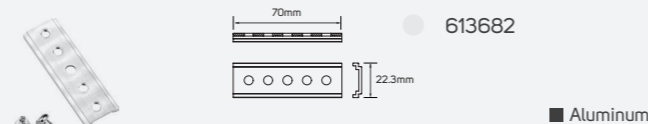

LED Magnetic Lights

Roman Romance

Technical Operating & Electrical Data

Operating Voltage	DC48V
IP Rating	IP20
Body Material	Aluminum
Rated CRI	90
Body Color	Sandy White
Beam Angle	30°
Mounting Type	Surface Mounted
Lifespan	30000H

Areas of Application

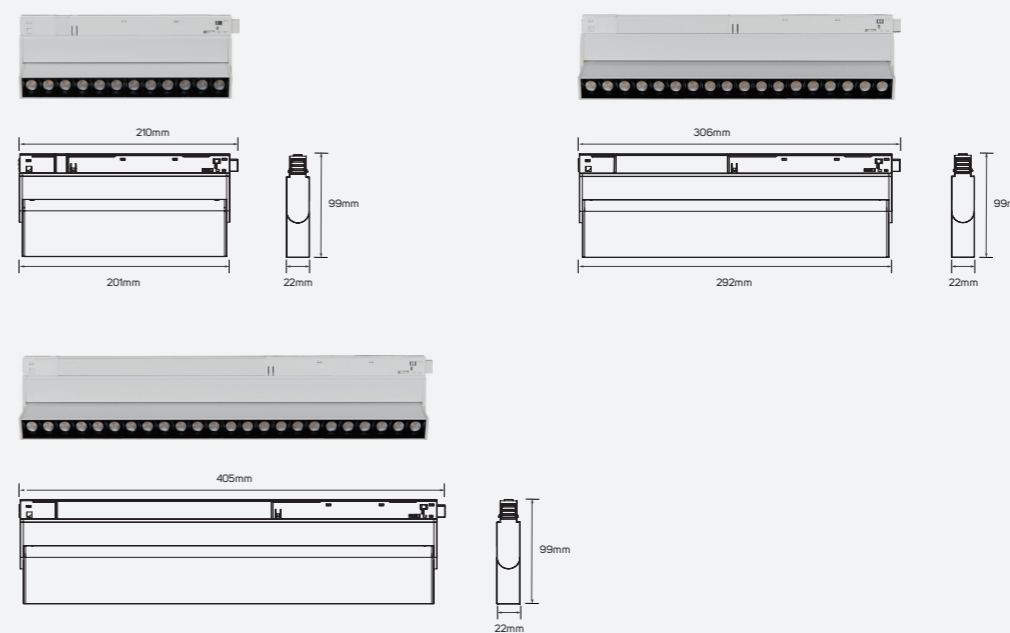
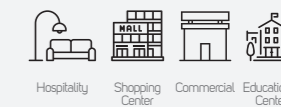

Family Product List

Code No.	Model No.	Power	Lumen	Efficacy	CCT
614532	ILS8.5W30DMTL930WWW02	8.5W	750lm	88.24lm/W	3000K
614533	ILS8.5W30DMTL940NWW02	8.5W	800lm	94.12lm/W	4000K
614534	ILS15W30DMTL930WWW02	15W	1300lm	86.67lm/W	3000K
614535	ILS15W30DMTL940NWW02	15W	1370lm	91.33lm/W	4000K
614536	ILS20W30DMTL930WWW02	20W	1750lm	87.50lm/W	3000K
614537	ILS20W30DMTL940NWW02	20W	1850lm	92.50lm/W	4000K

Recessed Magnetic Track Rail

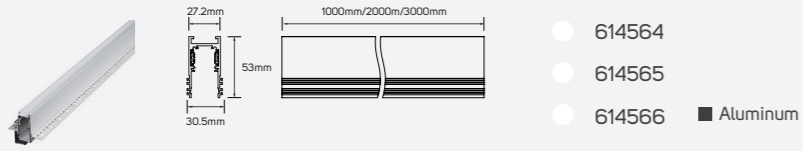

Pendant Magnetic Track Rail

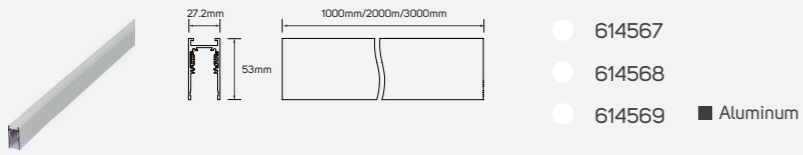

48V Magnetic Driver

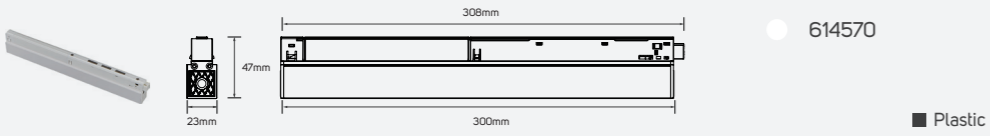

Recessed Horizontal Corner

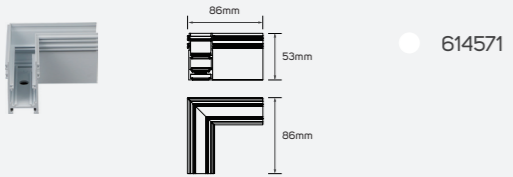

Recessed Inside Corner

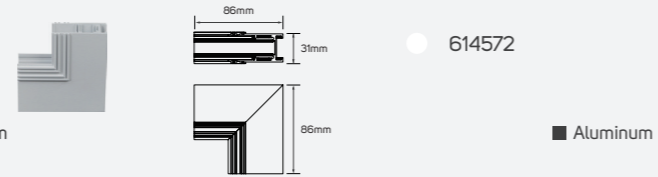

Surface Mounted Horizontal Corner

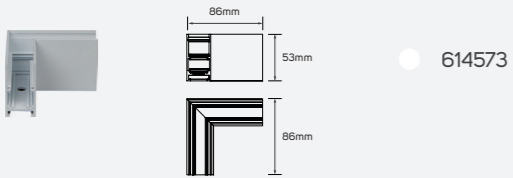

Surface Mounted Inside Corner

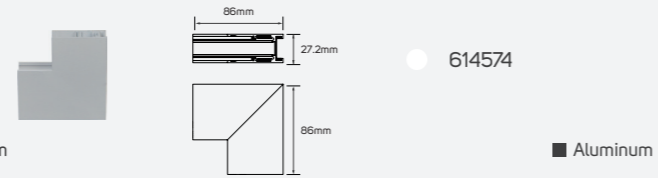

Flexible Corner Conductive Module

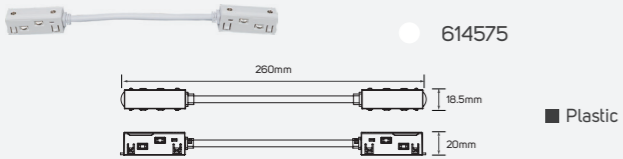

Direct Corner Conductive Module

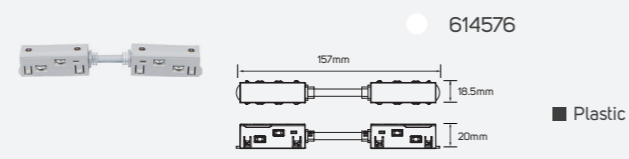

Cable Wire

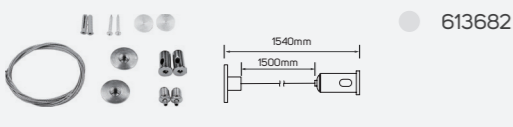

Cable Wire

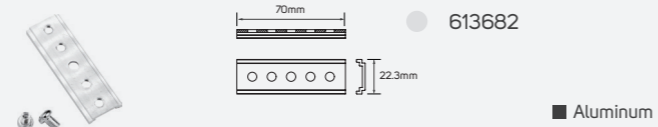



LED Magnetic Lights

PRODUCT INFORMATION

- Modern looking, neat luminaire offering comfortable, good quality lighting and can also work as a design element.
- Ideal lighting in the non-working areas of professional spaces such as offices, educational institutes, and also the welcoming areas and entrances of retail spaces.
- ILLUS LED MAGNETIC TRACK Light gives the customer the flexibility to choose between 8 models based on their specific need with lumen package from 570 lm to 1900 lm.

BENEFITS

- Clean and uniform light.
- Multiple application use.
- Easy to install and maintain.

FEATURES

- High CRI>90.
- Efficacy up to 81 lm/w.
- Long life span 30,000 hrs.
- Operating voltage DC48 V.
- Non – dimmable.

LED Magnetic Lights

Shimmering Moments

Technical Operating & Electrical Data

Operating Voltage	DC48V
IP Rating	IP20
Body Material	Aluminum
Rated CRI	90
Body Color	Sandy Black
Beam Angle	90°
Mounting Type	Surface Mounted
Lifespan	30000H

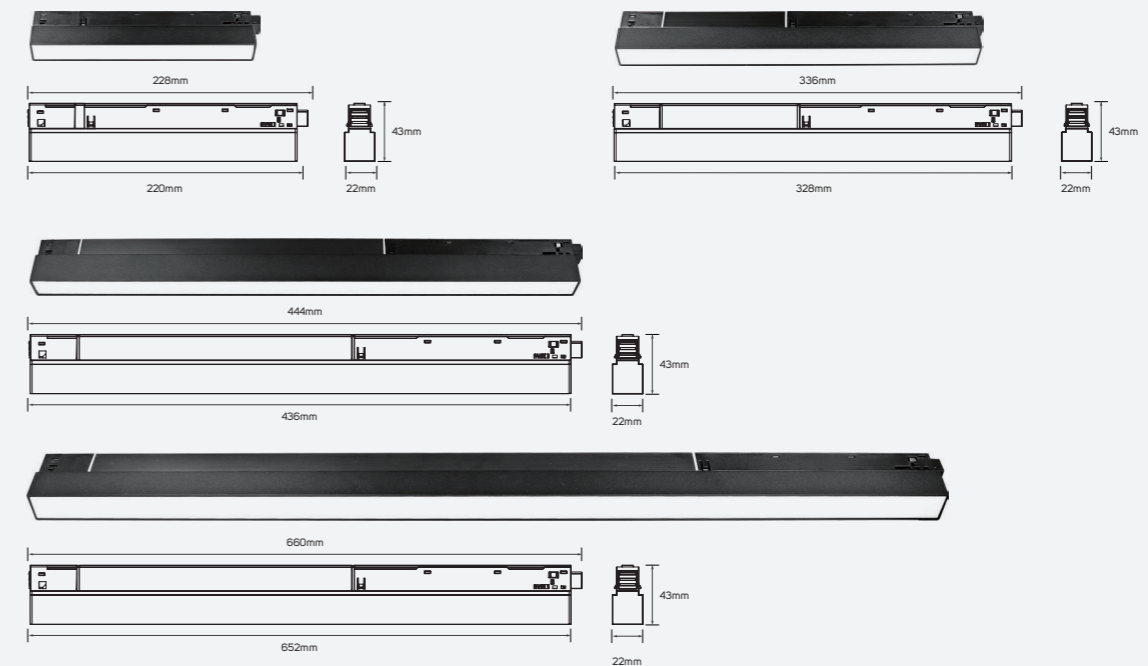

Areas of Application

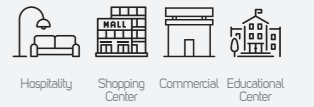

Family Product List

Code No.	Model No.	Power	Lumen	Efficacy	CCT
● 613643	ILS9W110DRTL930WW03	8W	570lm	71.25lm/W	3000K
● 613644	ILS9W110DRTL940NW03	8W	600lm	75lm/W	4000K
● 613645	ILS15W110DRTL930WW03	15W	1110lm	74lm/W	3000K
● 613646	ILS15W110DRTL940NW03	15W	1170lm	78lm/W	4000K
● 613647	ILS20W110DRTL930WW03	21W	1600lm	76.19lm/W	3000K
● 613648	ILS20W110DRTL940NW03	21W	1700lm	80.95lm/W	4000K
● 613649	ILS24W110DRTL930WW03	24W	1750lm	72.92lm/W	3000K
● 613650	ILS24W110DRTL940NW03	24W	1900lm	79.17lm/W	4000K

Recessed Magnetic Track Rail

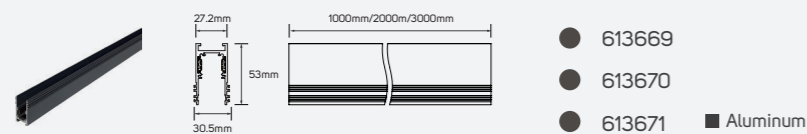

Pendant Magnetic Track Rail

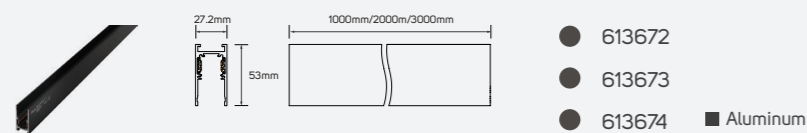

48V Magnetic Driver

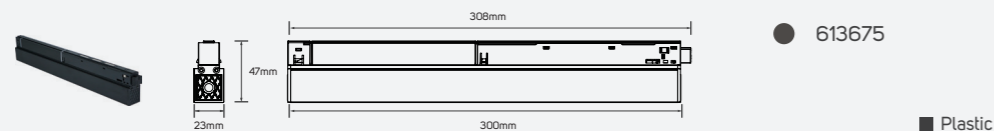

Recessed Horizontal Corner

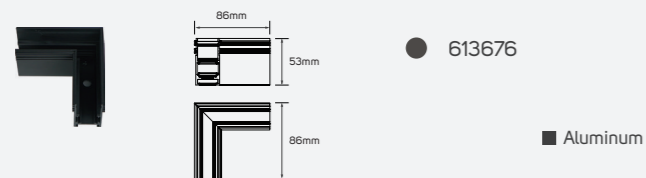

Recessed Inside Corner

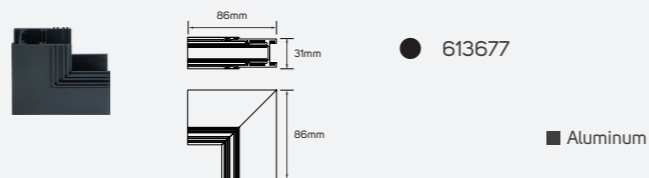

Surface Mounted Horizontal Corner

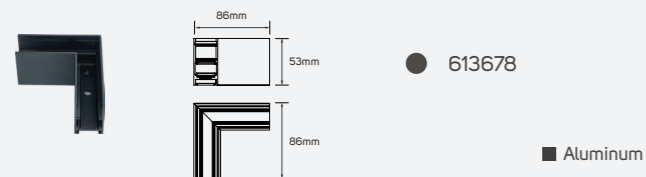

Surface Mounted Inside Corner

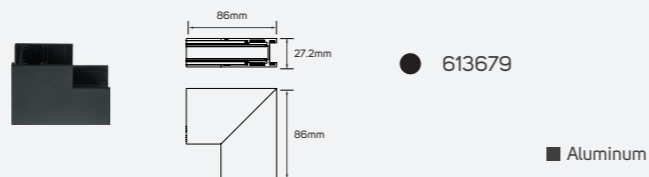

Flexible Corner Conductive Module

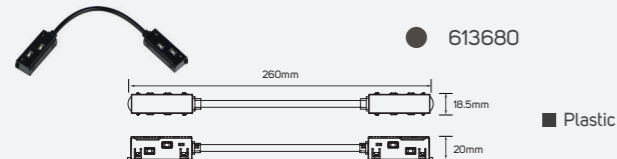

Direct Corner Conductive Module

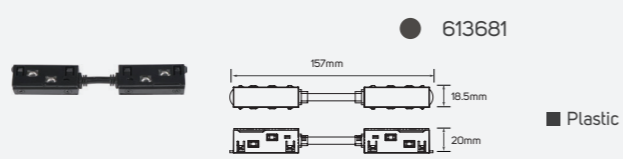

Cable Wire

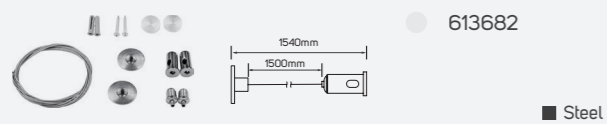

Cable Wire

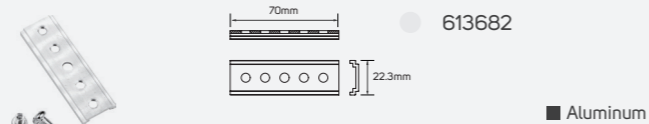

LED Magnetic Lights

Shimmering Moments

Areas of Application

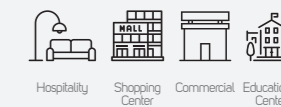

Technical Operating & Electrical Data

Operating Voltage	DC48V
IP Rating	IP20
Body Material	Aluminum
Rated CRI	90
Body Color	Sandy White
Beam Angle	90°
Mounting Type	Surface Mounted
Lifespan	30000H

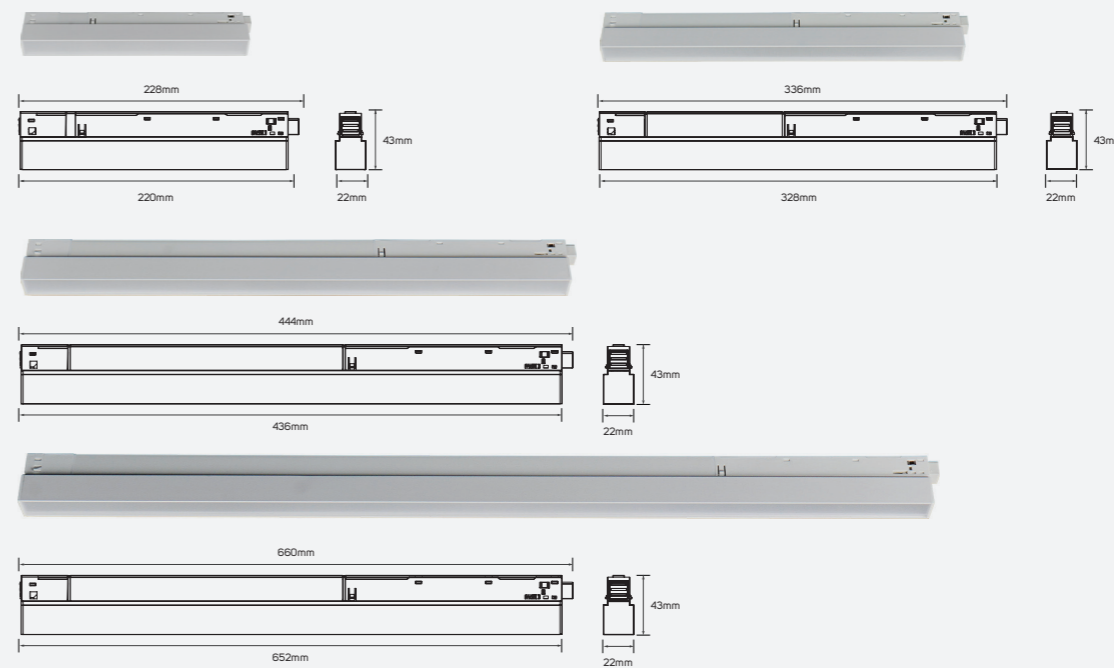

Family Product List

Code No.	Model No.	Power	Lumen	Efficacy	CCT
614538	ILS9W110DMTL930WW03	8W	570lm	71.25lm/W	3000K
614539	ILS9W110DMTL940NW03	8W	600lm	75lm/W	4000K
614540	ILS15W110DMTL930WW03	15W	1110lm	74lm/W	3000K
614541	ILS15W110DMTL940NW03	15W	1170lm	78lm/W	4000K
614542	ILS20W110DMTL930WW03	21W	1600lm	76.19lm/W	3000K
614543	ILS20W110DMTL940NW03	21W	1700lm	80.95lm/W	4000K
614544	ILS24W110DMTL930WW03	24W	1750lm	72.92lm/W	3000K
614545	ILS24W110DMTL940NW03	24W	1900lm	79.17lm/W	4000K

Recessed Magnetic Track Rail

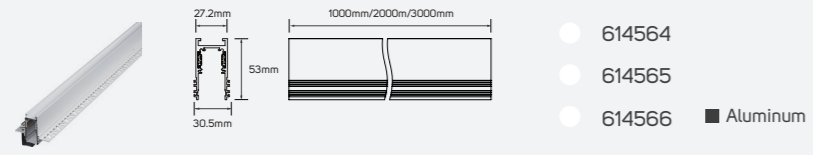

Pendant Magnetic Track Rail

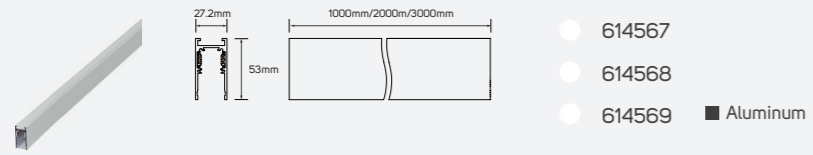

48V Magnetic Driver

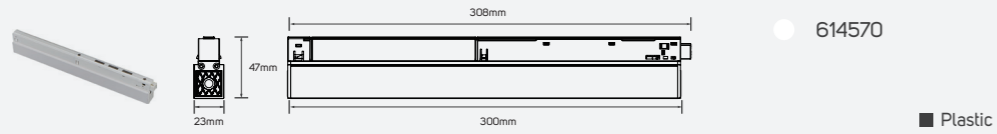

Recessed Horizontal Corner

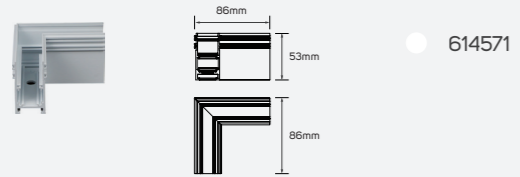

Recessed Inside Corner

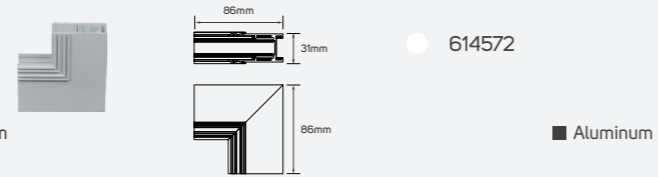

Surface Mounted Horizontal Corner

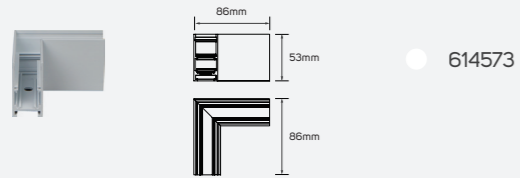

Surface Mounted Inside Corner

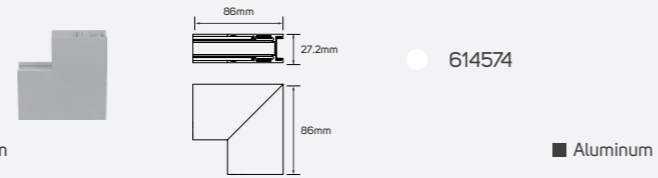

Flexible Corner Conductive Module

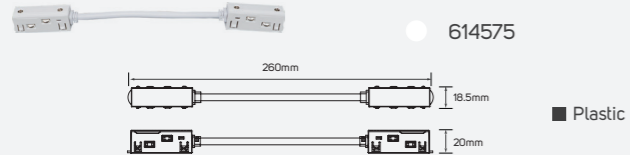

Direct Corner Conductive Module

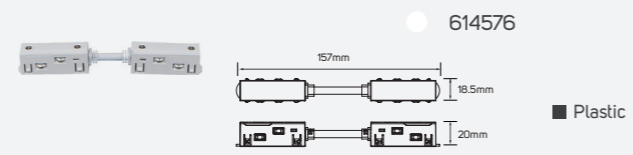

Cable Wire

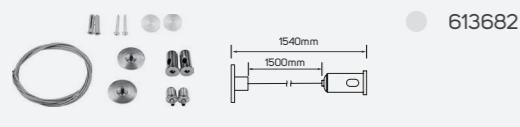

Cable Wire

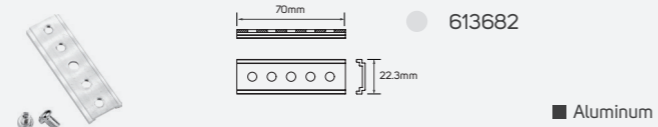



LED Magnetic Lights

Rhythmic Joy

Technical Operating & Electrical Data

Operating Voltage	DC48V
IP Rating	IP20
Body Material	Aluminum
Rated CRI	90
Body Color	Sandy Black
Beam Angle	24°
Mounting Type	Track Mounted
Lifespan	30000H

Areas of Application

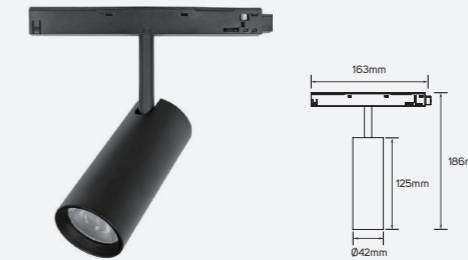
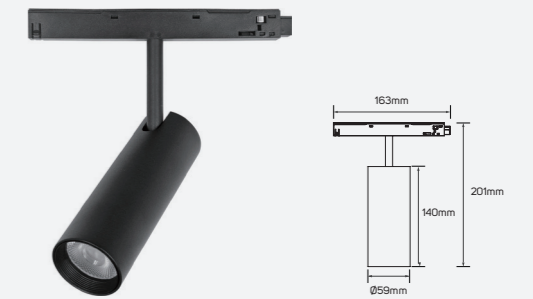
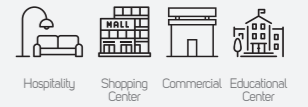

Family Product List

Code No.	Model No.	Power	Lumen	Efficacy	CCT
● 613651	ILS9W24DMTSL930WW01	8W	800lm	100lm/W	3000K
● 613652	ILS9W24DMTSL940NW01	8W	850lm	106.25lm/W	4000K
● 613653	ILS12W24DMTSL930WW01	12.5W	1150lm	92lm/W	3000K
● 613654	ILS12W24DMTSL940NW01	12.5W	1220lm	97.60lm/W	4000K
● 613655	ILS18W24DMTSL930WW01	16W	1350lm	84.38lm/W	3000K
● 613656	ILS18W24DMTSL940NW01	16W	1450lm	90.63lm/W	4000K

Recessed Magnetic Track Rail

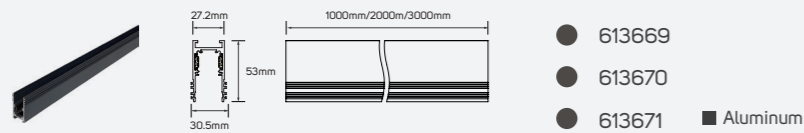

Pendant Magnetic Track Rail

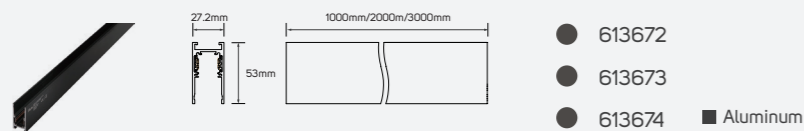

48V Magnetic Driver

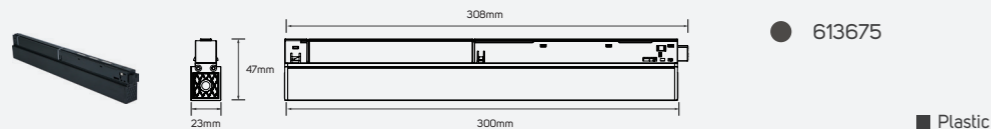

Recessed Horizontal Corner

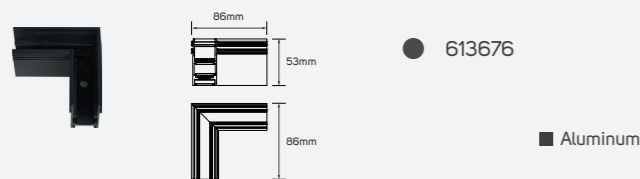

Recessed Inside Corner

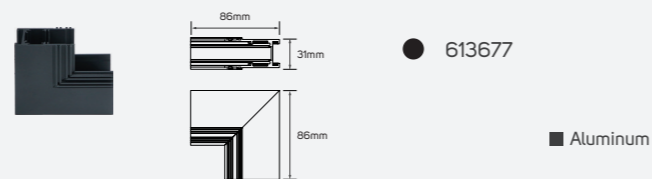

Surface Mounted Horizontal Corner

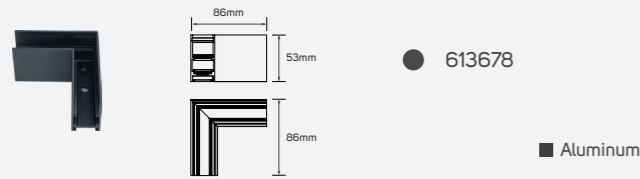

Surface Mounted Inside Corner

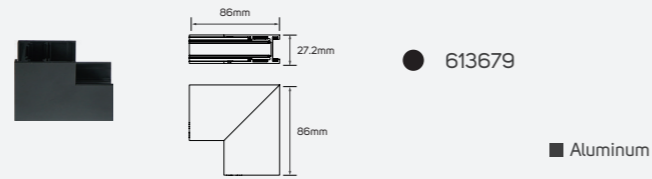

Flexible Corner Conductive Module

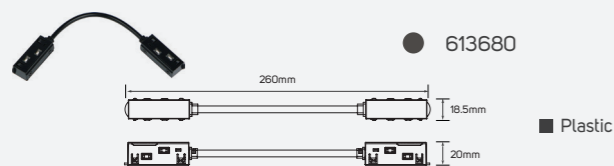

Direct Corner Conductive Module

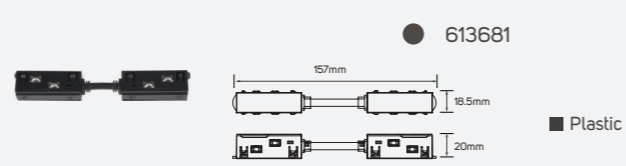

Cable Wire

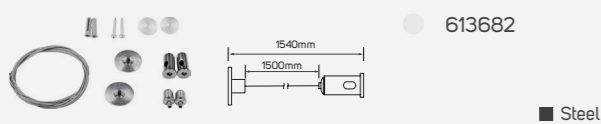

Cable Wire

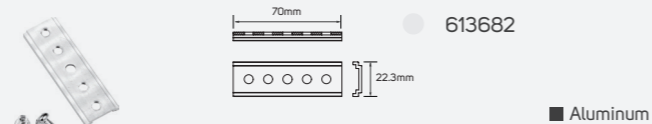

LED Magnetic Lights

Rhythmic Joy

Technical Operating & Electrical Data

Operating Voltage	DC48V
IP Rating	IP20
Body Material	Aluminum
Rated CRI	90
Body Color	Sandy White
Beam Angle	24°
Mounting Type	Track Mounted
Lifespan	30000H

Areas of Application

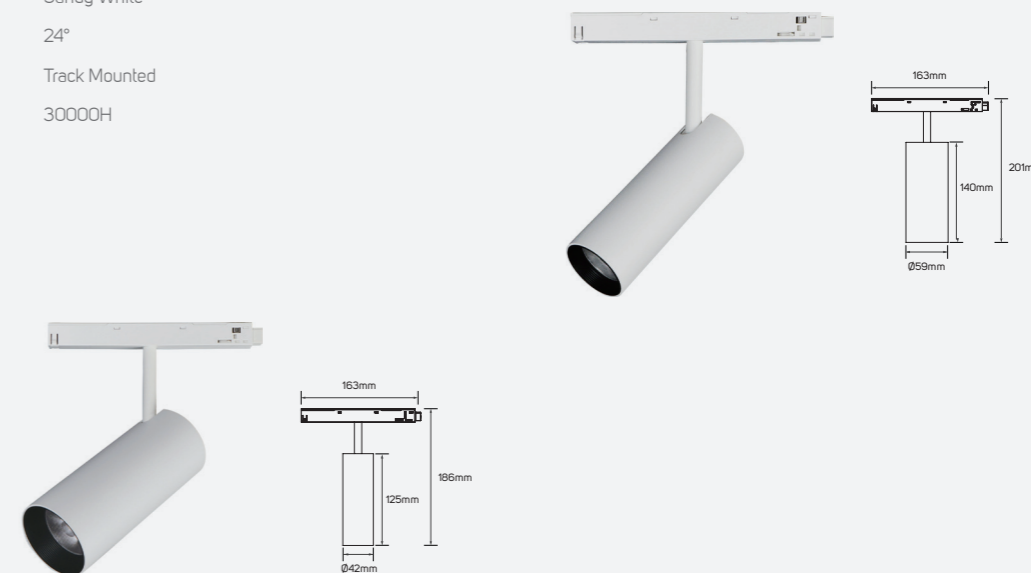
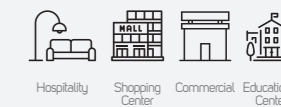

Family Product List

Code No.	Model No.	Power	Lumen	Efficacy	CCT
614546	ILS8W24DMTSL930WWW01	8W	800lm	100lm/W	3000K
614547	ILS8W24DMTSL940NWW01	8W	850lm	106.25lm/W	4000K
614548	ILS12.5W24DMTSL930WWW01	12.5W	1150lm	92lm/W	3000K
614549	ILS12.5W24DMTSL940NWW01	12.5W	1220lm	97.60lm/W	4000K
614550	ILS16W24DMTSL930WWW01	16W	1350lm	84.38lm/W	3000K
614551	ILS16W24DMTSL940NWW01	16W	1450lm	90.63lm/W	4000K

Recessed Magnetic Track Rail

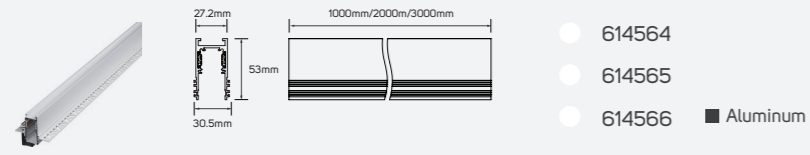

Pendant Magnetic Track Rail

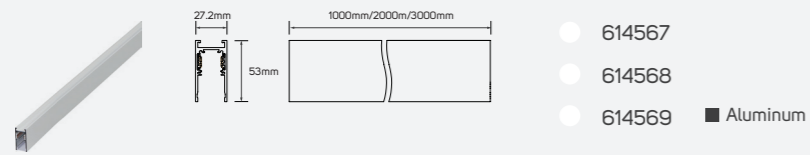

48V Magnetic Driver

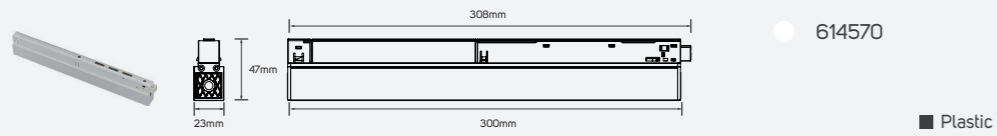

Recessed Horizontal Corner

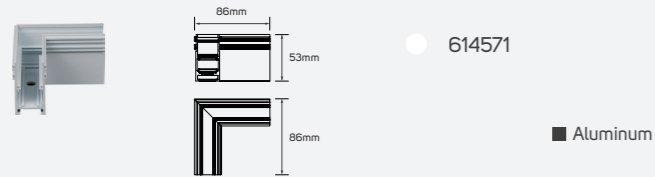

Recessed Inside Corner

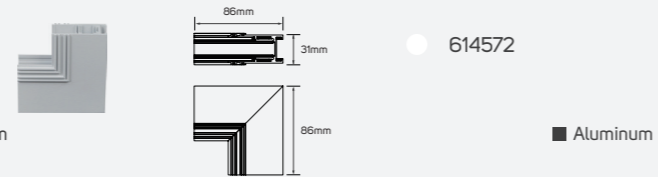

Surface Mounted Horizontal Corner

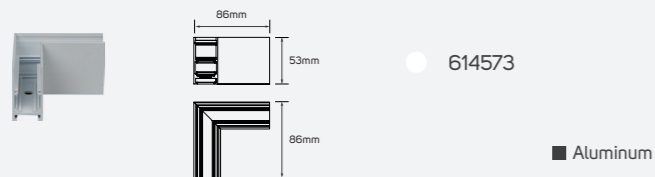

Surface Mounted Inside Corner

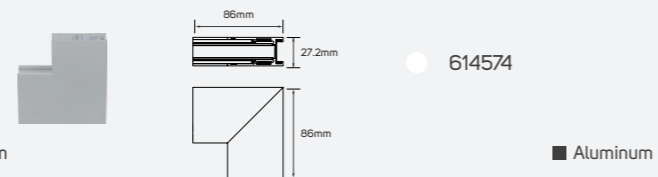

Flexible Corner Conductive Module

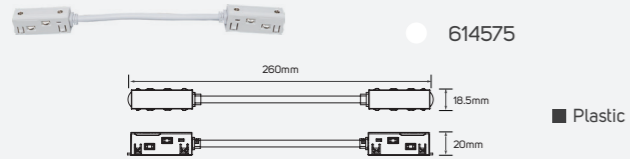

Direct Corner Conductive Module

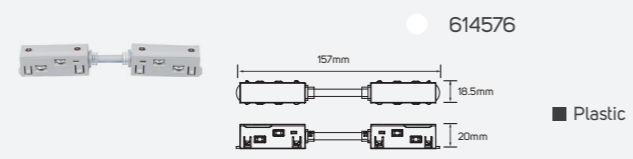

Cable Wire

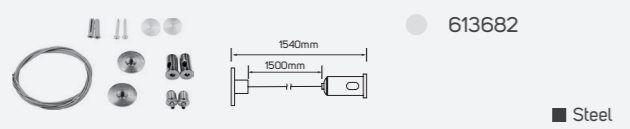

Cable Wire

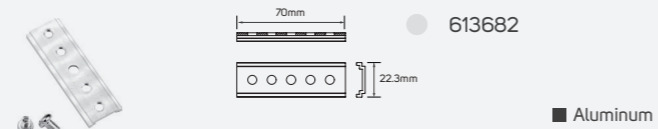



LED Recessed & Surface Mounted Ceiling Luminaire

- LED Flat Luminaire Series
- IP65 Downlight
- SMD
- SMD CCT
- Mini Downlight
- LED Recessed Ceiling Luminaire



Led Flat Luminaire Series

Areas of Application

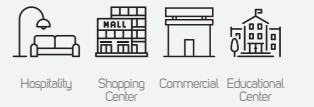

SkyGlow

Technical Operating & Electrical Data

Input Voltage & Frequency	AC220-240V, 50/60Hz
IP Rating	IP44 (Front)- IP20 (Back)
Body Material	Steel+Polystyrene
Ambient Temperature	-20°C~40°C
Body Color	White
Beam Angle	120°
Dimming	Non-Dimmable
Lifespan	50000H
Switching Cycle	100000x on/off
Warranty Period	60 Months

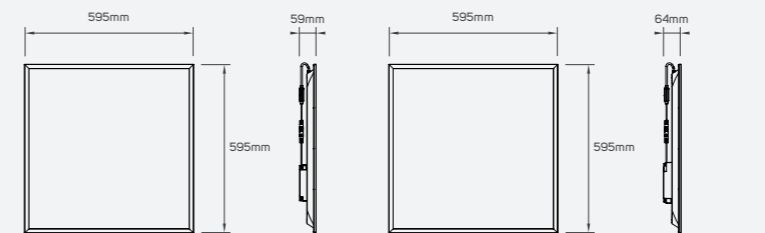

LI615529

LI615530

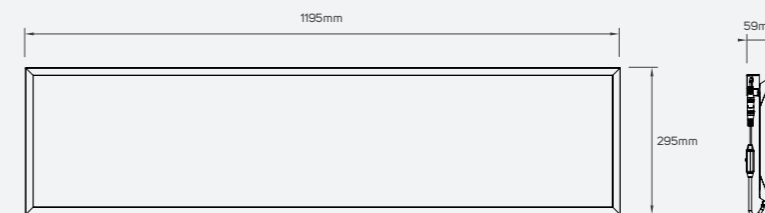

LI615531

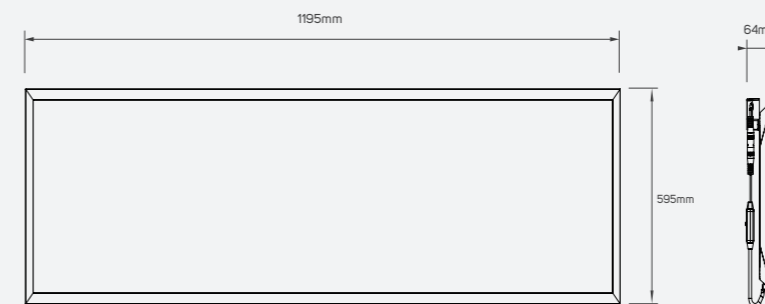

LI615532

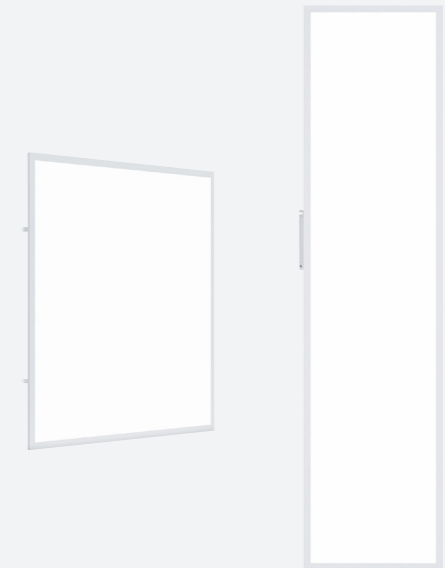

Led Flat Luminaire Series

PRODUCT INFORMATION

- Innovative, easy to use and high-quality luminaires.
- Provide better wide beam light distribution for straightforward and effective lighting.
- ILLUS LED FLAT Luminaire gives the customer the flexibility to choose between 4 models based on their specific need with lumen package from 4200lm to 6400lm.

BENEFITS

- Save on energy and maintenance costs.
- Support fast and flexible installation.
- Ideal for general application projects with a robust design and high water and dust proof rating.

FEATURES

- High CRI95.
- Long lifespan 50000H.
- Operating voltage AC220-240V.
- Tunable CCT.

Family Product List

Code No.	Model No.	Power	Lumen	Efficacy	CCT	Current	CRI
615529	ILS36FLTL9CCTW01	36W	4200lm	116.67lm/W	3000/4000/5700K	160mA	90
615530	ILS50FLTL9CCTW01	50W	6200lm	124lm/W	3000/4000/5700K	220mA	90
615531	ILS36FLTL9CCTW02	36W	4300lm	119.44lm/W	3000/4000/5700K	160mA	90
615532	ILS50FLTL9CCTW02	50W	6400lm	128lm/W	3000/4000/5700K	220mA	90



IP65 Downlight

RainShine

Areas of Application

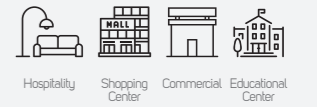

Technical Operating & Electrical Data

Input Voltage & Frequency	AC220-240V, 50/60Hz
IP Rating	IP65
Body Material	Aluminum
Mounting Type	Recessed in Ceiling
Dimming	Non-Dimmable
Lifespan	50000H



Body Color Options



Reflector Color Options

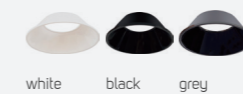

Surface mounted kit Color Options

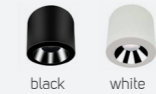

Lens Options



Dimensions Options

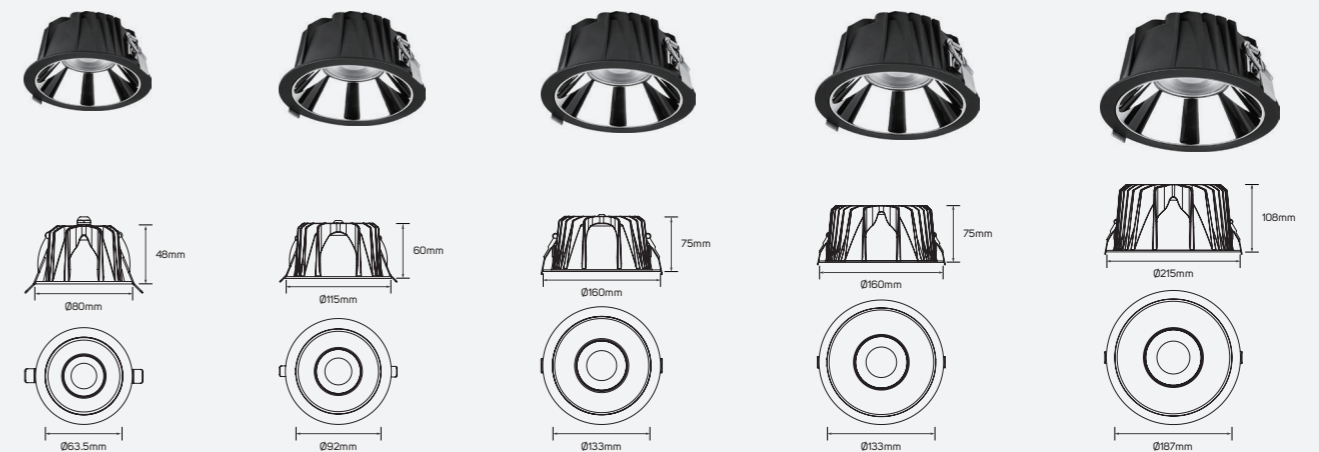

IP65 Downlight

PRODUCT INFORMATION

- Suitable for a series of lighting applications in office, retail and general area lighting.
- Available in a wide variety of lumen packs, cut out size and color temperature.
- ILLUS LED RECESSED CEILING Luminaire gives the customer the flexibility to choose between 30 models based on their specific need with lumen package from 610 lm to 4500 lm.

BENEFITS

- Compact design for better integration with the building.
- Comfortable light with high efficiency.
- Reliable performance for indoor applications.

FEATURES

- High CRI>90.
- Efficacy up to 82lm/w.
- Long life span 50,000 hrs.
- Operating voltage AC220 – 240V.
- Non – dimmable.



Reflector Specifications

■ Plastic



- 613112
- 613113
- 613114



- 613115
- 613116
- 613117

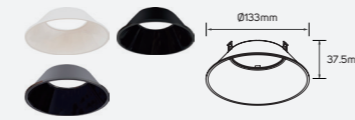

- 613118
- 613119
- 613120



- 613121
- 613122
- 613123

Surface Mounted Kit Specifications

■ Plastic

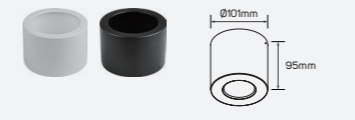

- 613124
- 613125

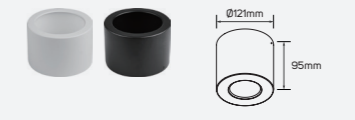

- 613126
- 613127

Lens Specifications

■ PC



- 614219
- 614220
- 614319

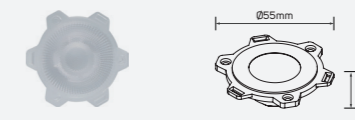

- 614221
- 614222
- 614320

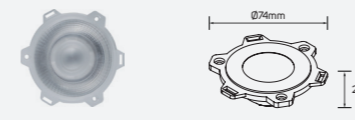

- 614223



- 614224

Family Product List

Code No.	Model No.	Body Color	Power	Lumen	Efficacy	CCT	Beam Angle	Cutting Size
● 613077	ILS9DLO930WW01	white	9W	610lm	67.78lm/w	3000K	24°	Ø70mm
● 613078	ILS9DLO940NW01	white	9W	640lm	71.11lm/w	4000K	24°	Ø70mm
● 613079	ILS9DLO950DL01	white	9W	660lm	73.33lm/w	5000K	24°	Ø70mm
● 613080	ILS9DLO930WW02	black	9W	610lm	67.78lm/w	3000K	24°	Ø70mm
● 613081	ILS9DLO940NW02	black	9W	640lm	71.11lm/w	4000K	24°	Ø70mm
● 613082	ILS9DLO950DL02	black	9W	660lm	73.33lm/w	5000K	24°	Ø70mm
● 613083	ILS15DLO930WW01	white	15W	1120lm	74.67lm/w	3000K	24°	Ø100mm
● 613084	ILS15DLO940NW01	white	15W	1130lm	75.33lm/w	4000K	24°	Ø100mm
● 613085	ILS15DLO950DL01	white	15W	1140lm	76lm/w	5000K	24°	Ø100mm
● 613086	ILS15DLO930WW02	black	15W	1120lm	74.67lm/w	3000K	24°	Ø100mm
● 613087	ILS15DLO940NW02	black	15W	1130lm	75.33lm/w	4000K	24°	Ø100mm
● 613088	ILS15DLO950DL02	black	15W	1140lm	76lm/w	5000K	24°	Ø100mm
● 613089	ILS20DLO930WW02	white	20W	1450lm	72.5lm/w	3000K	36°	Ø140mm
● 613090	ILS20DLO940NW02	white	20W	1510lm	75.5lm/w	4000K	36°	Ø140mm
● 613091	ILS20DLO950DL02	white	20W	1550lm	77.5lm/w	5000K	36°	Ø140mm
● 613092	ILS20DLO930WW01	black	20W	1450lm	72.5lm/w	3000K	36°	Ø140mm
● 613093	ILS20DLO940NW01	black	20W	1510lm	75.5lm/w	4000K	36°	Ø140mm
● 613094	ILS20DLO950DL01	black	20W	1550lm	77.5lm/w	5000K	36°	Ø140mm

Family Product List

Code No.	Model No.	Body Color	Power	Lumen	Efficacy	CCT	Beam Angle	Cutting Size
● 613095	ILS37DLO930WW01	white	37W	2700lm	72.98lm/w	3000K	36°	Ø200mm
● 613096	ILS37DLO940NW01	white	37W	2900lm	78.38lm/w	4000K	36°	Ø200mm
● 613097	ILS37DLO950DL01	white	37W	3050lm	82.43lm/w	5000K	36°	Ø200mm
● 613098	ILS37DLO930WW02	black	37W	2700lm	72.97lm/w	3000K	36°	Ø200mm
● 613099	ILS37DLO940NW02	black	37W	2900lm	78.39lm/w	4000K	36°	Ø200mm
● 613100	ILS37DLO950DL02	black	37W	3050lm	82.43lm/w	5000K	36°	Ø200mm
● 613101	ILS55DLO930WW01	white	55W	4000lm	72.73lm/w	3000K	36°	Ø200mm
● 613102	ILS55DLO940NW01	white	55W	4300lm	78.18lm/w	4000K	36°	Ø200mm
● 613103	ILS55DLO950DL01	white	55W	4500lm	81.82lm/w	5000K	36°	Ø200mm
● 613104	ILS55DLO930WW02	black	55W	4000lm	72.73lm/w	3000K	36°	Ø200mm
● 613105	ILS55DLO940NW02	black	55W	4300lm	78.18lm/w	4000K	36°	Ø200mm
● 613106	ILS55DLO950DL02	black	55W	4500lm	81.82lm/w	5000K	36°	Ø200mm



SMD

CloudWhite

Technical Operating & Electrical Data

Input Voltage & Frequency	AC220-240V, 50/60Hz
IP Rating	IP44
Body Material	Aluminum
Mounting Type	Recessed in Ceiling
Dimming	Non-Dimmable
Lifespan	50000H
Rated CRI	90

Areas of Application

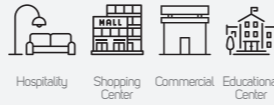

Family Product List

Code No.	Model No.	Power	Lumen	Efficacy	CCT	Beam Angle
613132	ILS7DL930WW02	7W	510lm	72.86lm/W	3000K	90°
613133	ILS7DL940NW02	7W	520lm	74.29lm/W	4000K	90°
613134	ILS7DL957DL02	7W	540lm	77.14lm/W	5700K	90°
613135	ILS10DL930WW02	10W	820lm	82lm/W	3000K	90°
613136	ILS10DL940NW02	10W	840lm	84lm/W	4000K	90°
613137	ILS10DL957DL02	10W	870lm	87lm/W	5700K	90°
613138	ILS15DL930WW02	15W	1250lm	83.33lm/W	3000K	90°
613139	ILS15DL940NW02	15W	1280lm	85.33lm/W	4000K	90°
613140	ILS15DL957DL02	15W	1320lm	88lm/W	5700K	90°
613141	ILS24DL930WW02	23W	2000lm	86.96lm/W	3000K	90°
613142	ILS24DL940NW02	23W	2040lm	88.70lm/W	4000K	90°
613143	ILS24DL957DL02	23W	2100lm	91.30lm/W	5700K	90°
613144	ILS36DL930WW02	35W	2950lm	84.29lm/W	3000K	90°
613145	ILS36DL940NW02	35W	3000lm	85.71lm/W	4000K	90°
613146	ILS36DL957DL02	35W	3060lm	87.43lm/W	5700K	90°

Driver

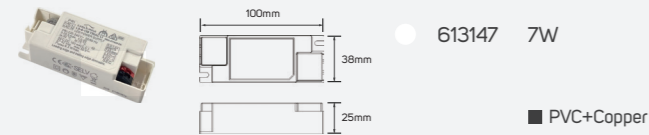

Driver

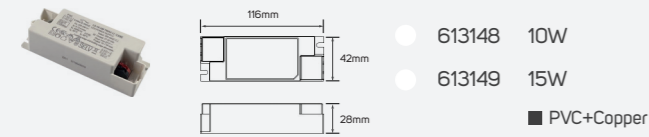

Driver

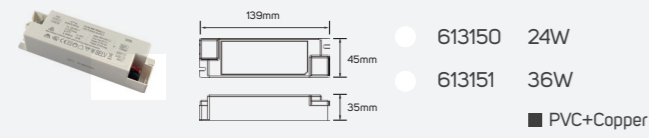

Dimensions Options

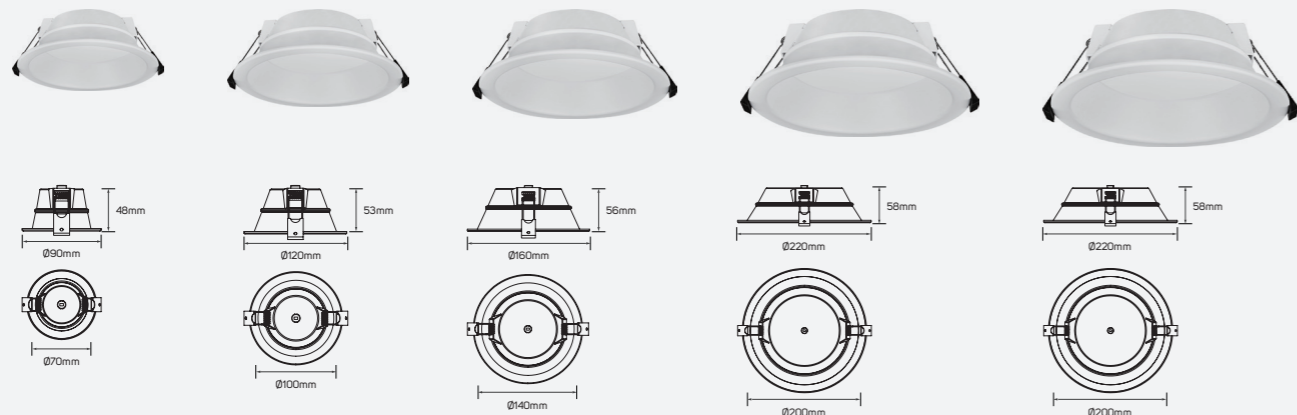

SMD CCT

Aurora

Areas of Application

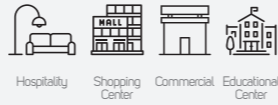

Technical Operating & Electrical Data

Input Voltage & Frequency	AC220-240V, 50/60Hz
IP Rating	IP20
Body Material	PA+PC
Mounting Type	Recessed in Ceiling
Dimming	Non-Dimmable
CCT	CCT-ADJUSTABLE, 3000K/4000K/6000K
Lifespan	15000h
Rated CRI	95
Beam Angle	90°



Family Product List

Code No.	Model No.	Power	Lumen
614170	ILS7WRDL304065K01	7W	3000K@550lm-4000K@590lm-6000K@560lm
614171	ILS10WRDL304065K01	9.5W	3000K@820lm-4000K@880lm-6000K@840lm
614172	ILS15WRDL304065K01	15W	3000K@1300lm-4000K@1420lm-6000K@1350lm
614173	ILS24WRDL304065K01	20W	3000K@1620lm-4000K@1750lm-6000K@1650lm
614174	ILS30WRDL304065K01	26W	3000K@2000lm-4000K@2250lm-6000K@2100lm

Reflector

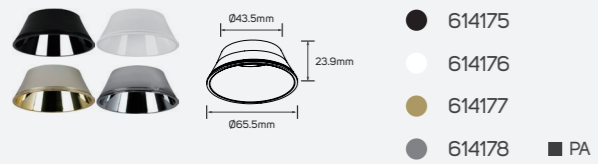

Reflector

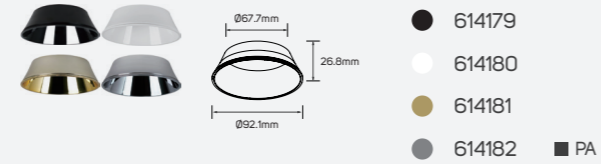

Reflector

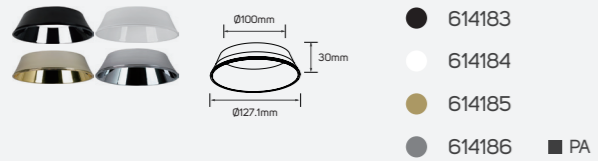

Reflector

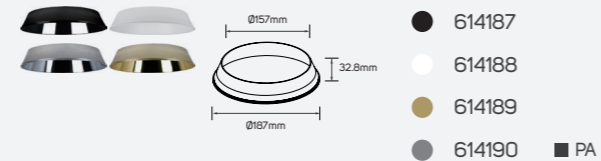

Dimensions Options

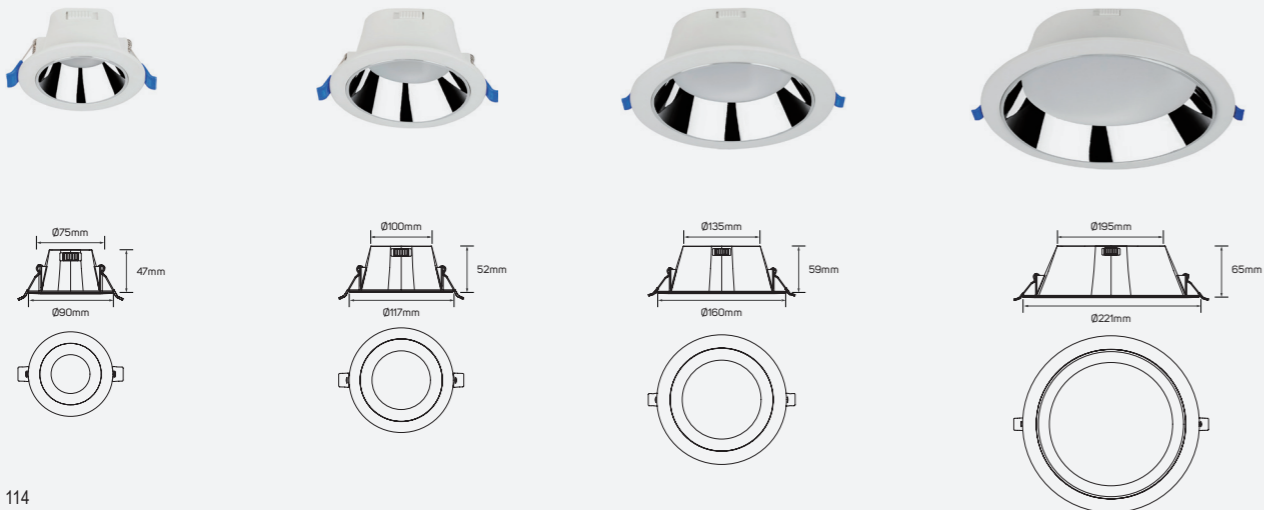

Starry

Technical Operating & Electrical Data

Input Voltage & Frequency	AC220-240V, 50/60Hz
IP Rating	IP20
Body Material	Die Casting Aluminum
Mounting Type	Recessed in Ceiling
Dimming	Non-Dimmable
Lifespan	30000H

Areas of Application

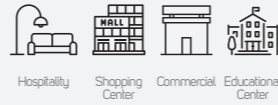

Dimensions Options

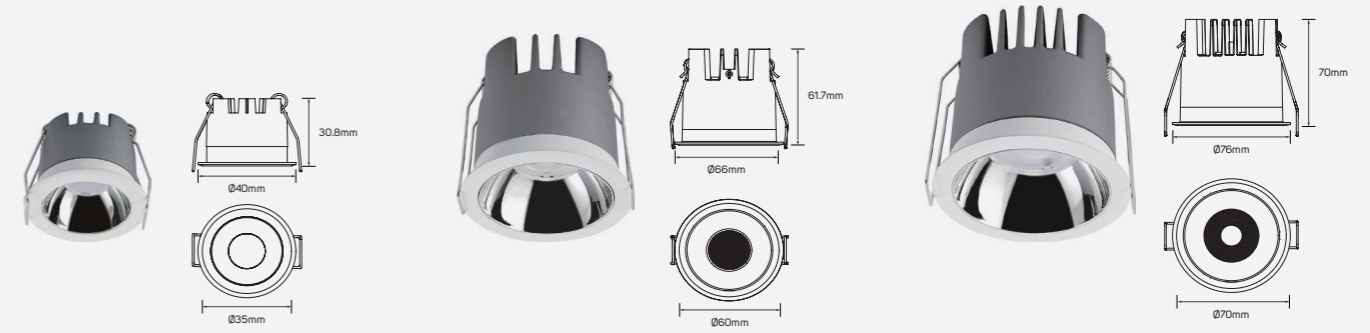

Reflector

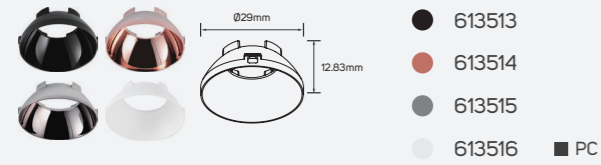

Reflector

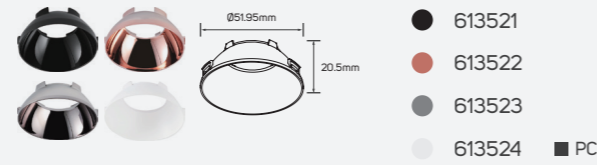

Reflector

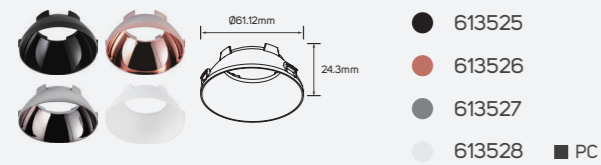

Frame

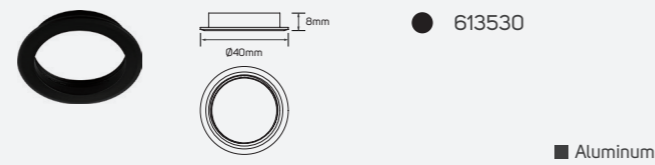

Frame

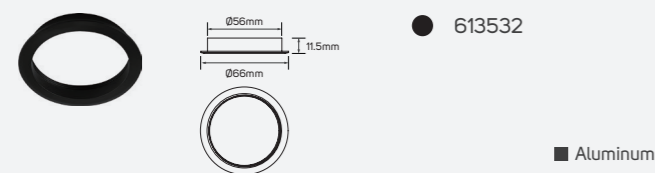

Frame

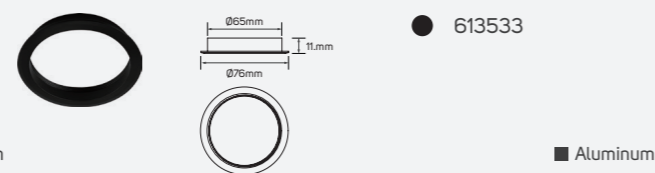

Lens

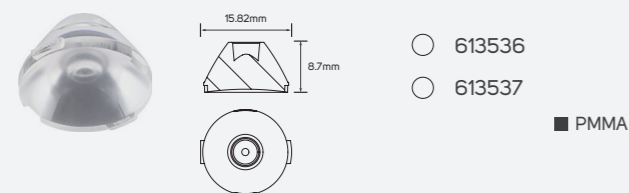

Lens

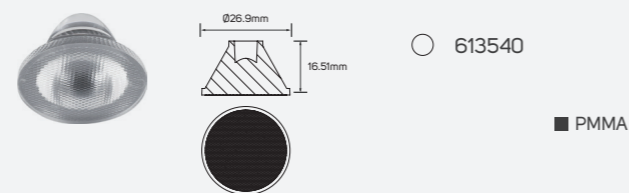

Lens

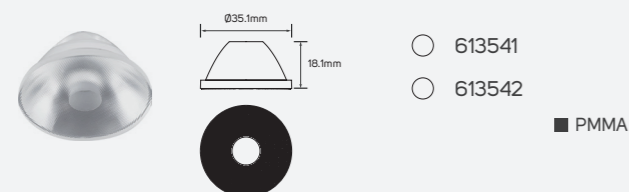

Family Product List

■ Die Casting Aluminum

Code No.	Model No.	Power	Lumen	Efficacy	CCT	Beam Angle
● 613497	ILS3MDL930WW01	3W	195lm	65lm/W	3000K	24°
● 613498	ILS3MDL940NW01	3W	205lm	68.33lm/W	4000K	24°
● 613499	ILS3MDL950DL01	3W	220lm	73.33lm/W	5000K	24°
● 613500	ILS8MDL930WW01	4.5W	350lm	77.78lm/W	3000K	24°
● 613501	ILS4.5MDL940NW01	4.5W	360lm	80lm/W	4000K	24°
● 613502	ILS4.5MDL950DL01	4.5W	380lm	84.44lm/W	5000K	24°
● 613503	ILS4.5MDL930WW01	8W	570lm	71.25lm/W	3000K	24°
● 613504	ILS8MDL940NW01	8W	590lm	73.75lm/W	4000K	24°
● 613505	ILS8MDL950DL01	8W	620lm	77.5lm/W	5000K	24°
● 613506	ILS12.5MDL930WW01	12.5W	970lm	77.6lm/W	3000K	24°
● 613507	ILS12.5MDL940NW01	12.5W	1000lm	80lm/W	4000K	24°
● 613508	ILS12.5MDL950DL01	12.5W	1050lm	84lm/W	5000K	24°



LED Recessed Ceiling Luminaire

PRODUCT INFORMATION

- Suitable for a series of lighting applications in office, retail and general area lighting.
- Available in a wide variety of lumen packs, cut out size and color temperature.
- ILLUS LED RECESSED CEILING Luminaire gives the customer the flexibility to choose between 16 models based on their specific need with lumen package from 460lm to 2550lm.

BENEFITS

- Compact design for better integration with the building.
- Comfortable light with high efficiency.
- Reliable performance for indoor applications.

FEATURES

- High CRI>95.
- Long life span 30,000 hrs.
- Operating voltage AC220 - 240V.
- Non - dimmable.

LED Recessed Ceiling Luminaire

ModernStylish

Technical Operating & Electrical Data

Input Voltage & Frequency	AC220-240V, 50/60Hz
IP Rating	IP20
Body Material	Aluminum
Rated CRI	95
Dimming	Non-Dimmable
Lifespan	30000H
Beam Angle	24°



Areas of Application



Family Product List

Code No.	Model No.	Power	Lumen	Efficacy	CCT	Body Color	
●	613802	ILS6WRSL930WW01	6.5W	460lm	70.77lm/w	3000K	White + Black
●	613803	ILS6WRSL930WW02	6.5W	460lm	70.77lm/w	3000K	Black
●	613804	ILS6WRSL940NW01	6.5W	470lm	72.31lm/w	4000K	White + Black
●	613805	ILS6WRSL940NW02	6.5W	470lm	72.31lm/w	4000K	Black
●	613808	ILS12WRSL930WW01	12W	900lm	75lmw	3000K	White + Black
●	613809	ILS12WRSL930WW02	12W	900lm	75lm/w	3000K	Black
●	613810	ILS12WRSL940NW01	12W	920lm	76.67lm/w	4000K	White + Black
●	613811	ILS12WRSL940NW02	12W	920lm	76.67lm/w	4000K	Black
●	613814	ILS24WRSL930WW01	24W	1680lm	70lm/w	3000K	White + Black
●	613815	ILS24WRSL930WW02	24W	1680lm	70lm/w	3000K	Black
●	613816	ILS24WRSL940NW01	24W	1720lm	71.67lm/w	4000K	White + Black
●	613817	ILS24WRSL940NW02	24W	1720lm	71.67lm/w	4000K	Black
●	613820	ILS35WRSL930WW01	35W	2500lm	71.43lm/w	3000K	White + Black
●	613821	ILS35WRSL930WW02	35W	2500lm	71.43lm/w	3000K	Black
●	613822	ILS35WRSL940NW01	35W	2550lm	72.86lm/w	4000K	White + Black
●	613823	ILS35WRSL940NW02	35W	2550lm	72.86lm/w	4000K	Black

LED Recessed Ceiling Luminaire

Areas of Application

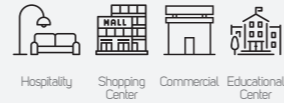

Keroro

Technical Operating & Electrical Data

Input Voltage & Frequency	AC220-240V, 50/60Hz
IP Rating	IP20
Body Material	Aluminum
Rated CRI	95
Dimming	Non-Dimmable
Lifespan	30000H
Beam Angle	24°

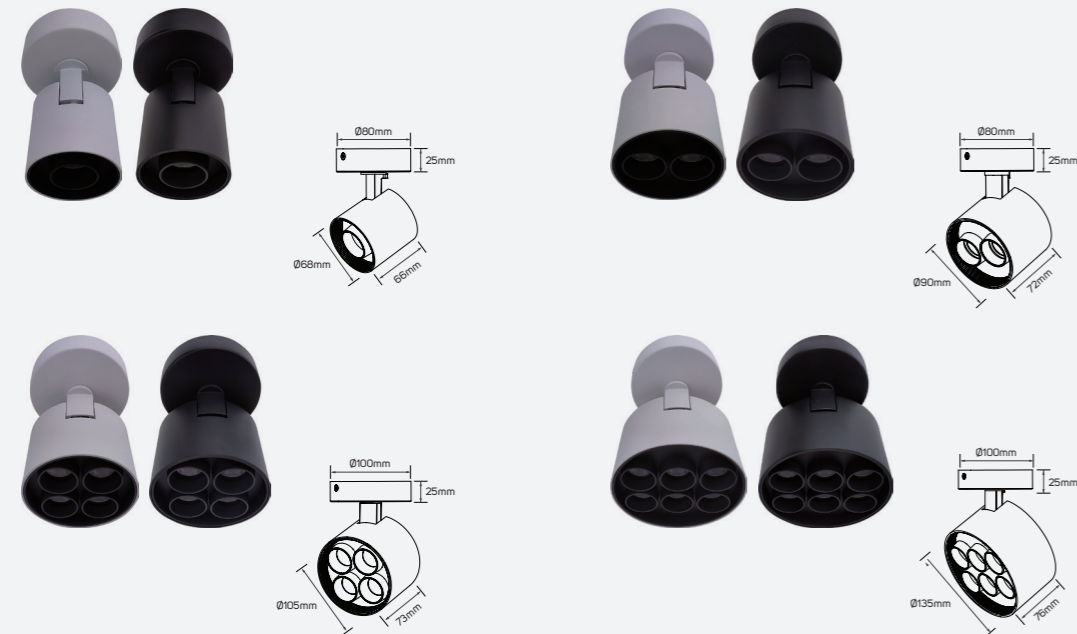

Family Product List

Code No.	Model No.	Power	Lumen	Efficacy	CCT	Body Color
▶ 613778	ILS6WSMSL930WW01	6.5W	460lm	70.77lm/w	3000K	White + Black
● 613779	ILS6WSMSL930WW02	6.5W	460lm	70.77lm/w	3000K	Black
▶ 613780	ILS6WSMSL940NW01	6.5W	470lm	72.31lm/w	4000K	White + Black
● 613781	ILS6WSMSL940NW02	6.5W	470lm	72.31lm/w	4000K	Black
▶ 613784	ILS12WSMSL930WW01	12W	900lm	75lm/w	3000K	White + Black
● 613785	ILS12WSMSL930WW02	12W	900lm	75lm/w	3000K	Black
▶ 613786	ILS12WSMSL940NW01	12W	920lm	76.67lm/w	4000K	White + Black
● 613787	ILS12WSMSL940NW02	12W	920lm	76.67lm/w	4000K	Black
▶ 613790	ILS24WSMSL930WW01	24W	1680lm	70lm/w	3000K	White + Black
● 613791	ILS24WSMSL930WW02	24W	1680lm	70lm/w	3000K	Black
▶ 613792	ILS24WSMSL940NW01	24W	1720lm	71.67lm/w	4000K	White + Black
● 613793	ILS24WSMSL940NW02	24W	1720lm	71.67lm/w	4000K	Black
▶ 613796	ILS35WSMSL930WW01	35W	2500lm	71.43lm/w	3000K	White + Black
● 613797	ILS35WSMSL930WW02	35W	2500lm	71.43lm/w	3000K	Black
▶ 613798	ILS35WSMSL940NW01	35W	2550lm	72.86lm/w	4000K	White + Black
● 613799	ILS35WSMSL940NW02	35W	2550lm	72.86lm/w	4000K	Black

LED Recessed Ceiling Luminaire

Areas of Application

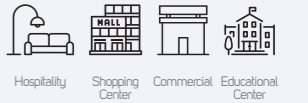

Glorya

Technical Operating & Electrical Data

Input Voltage & Frequency	AC220-240V, 50/60Hz
IP Rating	IP20
Body Material	Aluminum
Rated CRI	95
Dimming	Non-Dimmable
Lifespan	30000H
Beam Angle	24°

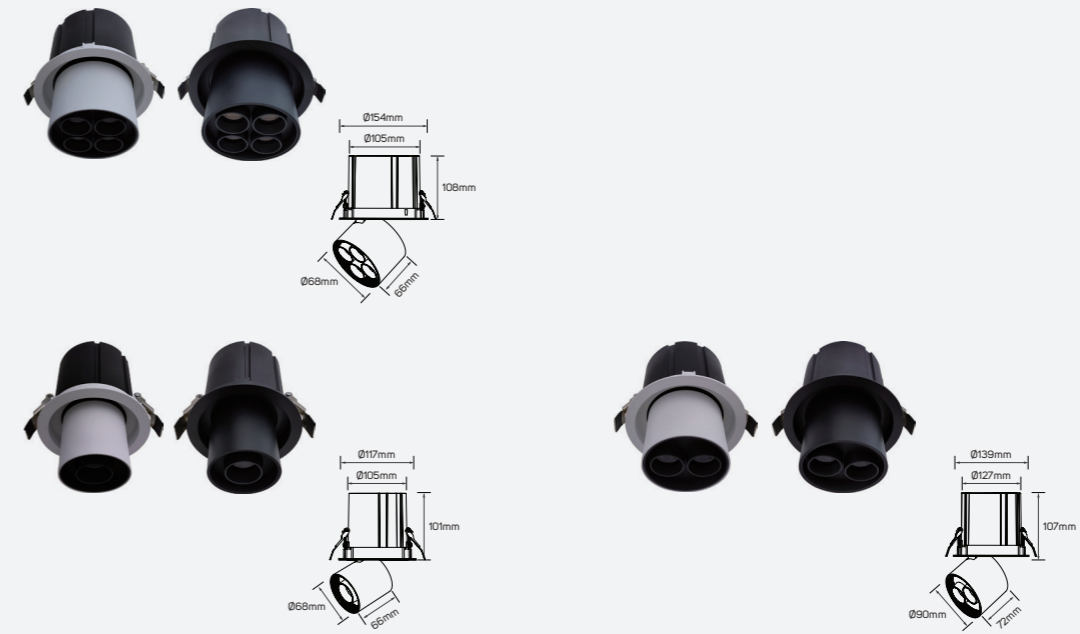

Family Product List

Code No.	Model No.	Power	Lumen	Efficacy	CCT	Body Color
▶ 613826	ILS6WPPRSL930WW01	6.5W	460lm	70.77lm/w	3000K	White + Black
● 613827	ILS6WPPRSL930WW02	6.5W	460lm	70.77lm/w	3000K	Black
▶ 613828	ILS6WPPRSL940NW01	6.5W	470lm	72.31lm/w	4000K	White + Black
● 613829	ILS6WPPRSL940NW02	6.5W	470lm	72.31lm/w	4000K	Black
▶ 613832	ILS12WPPRSL930WW01	12W	900lm	75lm/w	3000K	White + Black
● 613833	ILS12WPPRSL930WW02	12W	900lm	75lm/w	3000K	Black
▶ 613834	ILS12WPPRSL940NW01	12W	920lm	76.67lm/w	4000K	White + Black
● 613835	ILS12WPPRSL940NW02	12W	920lm	76.67lm/w	4000K	Black
▶ 613838	ILS24WPPRSL930WW01	24W	1680lm	70lm/w	3000K	White + Black
● 613839	ILS24WPPRSL930WW02	24W	1680lm	70lm/w	3000K	Black
▶ 613840	ILS24WPPRSL940NW01	24W	1720lm	71.67lm/w	4000K	White + Black
● 613841	ILS24WPPRSL940NW02	24W	1720lm	71.67lm/w	4000K	Black





LED Track & Track Rail Accessories

- Track Light Luminaire
- LED Track Mounted Luminaire
- LED Recessed Linear Light Luminaire
- LED Recessed Linear Light Luminaire (Trimless)
- LED Recessed Linear Light Luminaire (Wall Washer)
- LED Recessed Spot Light Luminaire
- LED Recessed Linear Luminaire
- LED Recessed Linear Luminaire-Corner
- LED Pendant Linear Light Luminaire
- LED Pendant Linear Luminaire-Corner

Track Light Luminaire

Areas of Application

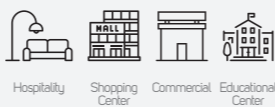

Artist-Impressionism

Technical Operating & Electrical Data

Input Voltage & Frequency	AC220-240V, 50/60Hz
IP Rating	IP20
Body Material	Aluminum+Plastic
Cap Type	GU10
Mounting Type	Track Mounted
Type of Frame	Adjustable



612119 - 612120



612121 - 612122

Family Product List

Code No.	Model No.	Max. Wattage	Body Color	Code No.	Model No.	Max. Wattage	Body Color
▶ 612119	ILSATMF09	Max.9W	white+black	612121	ILSATMF10	Max.9W	white+black
● 612120	ILSATMF09	Max.9W	black	612122	ILSATMF10	Max.9W	black

LED Track Mounted Luminaire

Areas of Application

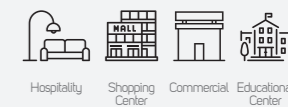

Moonlight Sonata

Technical Operating & Electrical Data

Input Voltage & Frequency	AC220-240V, 50/60Hz
IP Rating	IP20
Body Material	Aluminum+Plastic
Rated CRI	92
Beam Angle	24°
Type of Frame	Adjustable
Lifespan	30000H

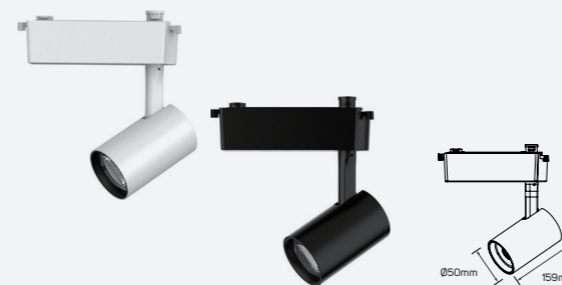

611769 - 611770 - 611771 - 611772



61173 - 61174 - 61175 - 61176

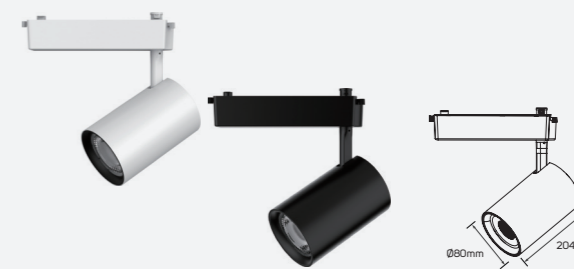

61177 - 61178 - 61179 - 61180

Family Product List

Code No.	Model No.	Power	Lumen	Efficacy	CCT	Current
▶ 611769	ILS12ATML930WW01	12W	920lm	77lm/W	3000k	53.6 mA
● 611770	ILS12ATML940NW01	12W	950lm	79lm/W	4000k	53.4 mA
▶ 611771	ILS12ATML930WW02	12W	920lm	77lm/W	3000k	54.6 mA
● 611772	ILS12ATML940NW02	12W	950lm	79lm/W	4000k	54 mA
▶ 611773	ILS20ATML930WW01	20W	1510lm	75lm/W	3000k	96.9 mA
● 611774	ILS20ATML940NW01	20W	1570lm	78lm/W	4000k	96.7 mA
▶ 611775	ILS20ATML930WW02	20W	1510lm	75lm/W	3000k	96.9 mA
● 611776	ILS20ATML940NW02	20W	1570lm	78lm/W	4000k	96.7 mA
▶ 611777	ILS31ATML930WW01	31W	2490lm	80lm/W	3000k	142.4 mA
● 611778	ILS31ATML940NW01	31W	2550lm	82lm/W	4000k	136.8 mA
▶ 611779	ILS31ATML930WW02	31W	2490lm	80lm/W	3000k	142.4 mA
● 611780	ILS31ATML940NW02	31W	2550lm	82lm/W	4000k	136.8 mA

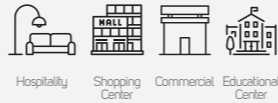

Poetic Moments

Technical Operating & Electrical Data

Input Voltage & Frequency	AC220-240V, 50/60Hz
IP Rating	IP20
Body Material	Aluminum+Plastic
Rated CRI	95
Beam Angle	24°
Type of Frame	Adjustable
Lifespan	50000H

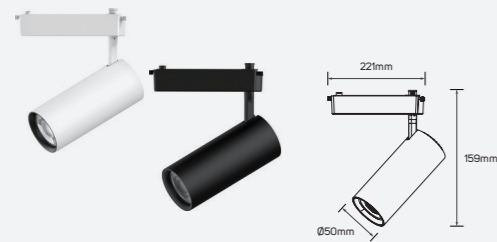

613195 - 613196 - 613197 - 613198

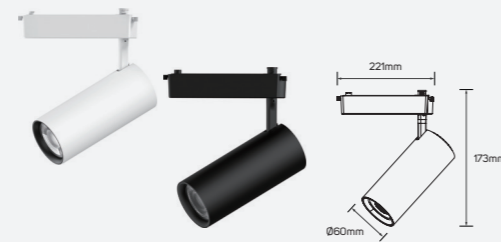

613199 - 613200 - 613201 - 613202

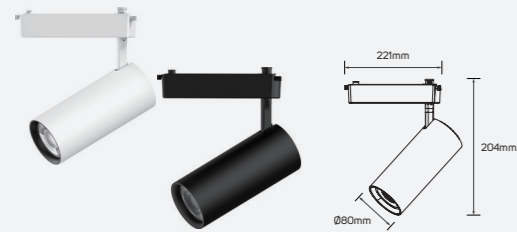

613203 - 613204 - 613205 - 613206



613207 - 613208 - 613209 - 613210

Family Product List

Code No.	Model No.	Power	Lumen	Efficacy	CCT	Body Color
► 613195	ILS11.5ATML930WW01	11.5W	950lm	82.61lm/W	3000k	matt white+black ring
► 613196	ILS11.5ATML940NW01	11.5W	1000lm	86.96lm/W	4000k	matt white+black ring
● 613197	ILS11.5ATML930WW02	11.5W	950lm	82.61lm/W	3000k	matt black
● 613198	ILS11.5ATML940NW02	11.5W	1000lm	86.96lm/W	4000k	matt black
► 613199	ILS19.5ATML930WW01	19.5W	1510lm	77.44lm/W	3000k	matt white+black ring
► 613200	ILS19.5ATML940NW01	19.5W	1600lm	82.05lm/W	4000k	matt white+black ring
● 613201	ILS19.5ATML930WW02	19.5W	1510lm	77.44lm/W	3000k	matt black
● 613202	ILS19.5ATML940NW02	19.5W	1600lm	82.05lm/W	4000k	matt black
► 613203	ILS30ATML930WW01	30W	2600lm	86.67lm/W	3000k	matt white+black ring
► 613204	ILS30ATML940NW01	30W	2800lm	93.33lm/W	4000k	matt white+black ring
● 613205	ILS30ATML930WW02	30W	2600lm	86.67lm/W	3000k	matt black
● 613206	ILS30ATML940NW02	30W	2800lm	93.33lm/W	4000k	matt black
► 613207	ILS40ATML930WW01	40W	3100lm	77.50lm/W	3000k	matt white+black ring
► 613208	ILS40ATML940NW01	40W	3300lm	82.50lm/W	4000k	matt white+black ring
● 613209	ILS40ATML930WW02	40W	3100lm	77.50lm/W	3000k	matt black
● 613210	ILS40ATML940NW02	40W	3300lm	82.50lm/W	4000k	matt black





Led Recessed Linear Light Luminaire

Areas of Application

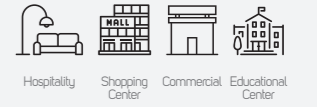

GlowMist

Technical Operating & Electrical Data

Input Voltage & Frequency	AC220-240V, 50/60Hz
IP Rating	IP20
Body Material	Aluminum+PC
Rated CRI	95
Body Color	Black
Beam Angle	28°
Dimming	Non-Dimmable
Lifespan	30000H
Switching Cycle	100000x on/off
Warranty Period	36 Months

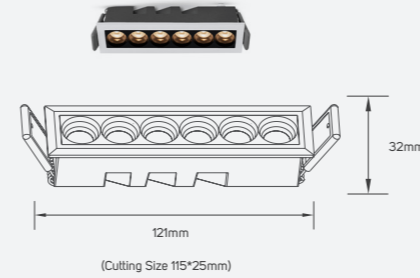

LI614983 - LI614984 - LI614985 - LI614987 - LI614988 - LI614989

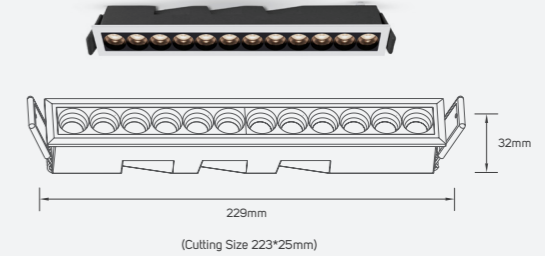

LI614991 - LI614992 - LI614993 - LI614995 - LI614996 - LI614997

Led Recessed Linear Light Luminaire

PRODUCT INFORMATION

- Modern looking, neat luminaire offering comfortable, good quality lighting and can also work as a design element.
- Ideal lighting in the non-working areas of professional spaces such as offices, educational institutes, and also the welcoming areas and entrances of retail spaces.
- ILLUS LED RECESSED LINEAR Luminaire gives the customer the flexibility to choose between 12 models based on their specific need with lumen package from 600lm to 1800lm.

BENEFITS

- Clean and uniform light.
- Multiple application use.
- Easy to install and maintain.

FEATURES

- High CRI>95.
- Efficacy up to 108lm/w.
- Lifespan 30000H.
- Operating voltage AC220-240V.
- Non-Dimmable.

Family Product List

Code No.	Model No.	Power	Lumen	Efficacy	CCT	Saving Energy	Current	Equivalent
● 614983	ILS6WGDL930WW01	6W	600lm	100lm/W	3000K	93%	50mA	83W
● 614984	ILS6WGDL940NW01	6W	620lm	103.33lm/W	4000K	93%	50mA	86W
● 614985	ILS6WGDL950DL01	6W	650lm	108.33lm/W	5000K	93%	50mA	90W
● 614987	ILS10WGDL930WW01	10W	820lm	82lm/W	3000K	91%	83mA	112W
● 614988	ILS10WGDL940NW01	10W	850lm	85lm/W	4000K	91%	83mA	116W
● 614989	ILS10WGDL950DL01	10W	890lm	89lm/W	5000K	92%	83mA	121W
● 614991	ILS12WGDL930WW01	12W	1150lm	95.83lm/W	3000K	92%	100mA	155W
● 614992	ILS12WGDL940NW01	12W	1200lm	100lm/W	4000K	93%	100mA	162W
● 614993	ILS12WGDL950DL01	12W	1270lm	105.83lm/W	5000K	93%	100mA	171W
● 614995	ILS20WGDL930WW01	20W	1650lm	82.50lm/W	3000K	91%	150mA	220W
● 614996	ILS20WGDL940NW01	20W	1720lm	86lm/W	4000K	91%	150mA	229W
● 614997	ILS20WGDL950DL01	20W	1800lm	90lm/W	5000K	92%	150mA	240W

Led Recessed Linear Light Luminaire (Trimless)

Areas of Application

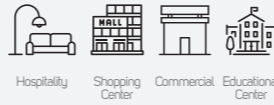

Luma

Technical Operating & Electrical Data

Input Voltage & Frequency	AC220-240V, 50/60Hz
IP Rating	IP20
Body Material	Aluminum+PC
Rated CRI	95
Body Color	White
Beam Angle	28°
Dimming	Non-Dimmable
Lifespan	30000H
Switching Cycle	10000x on/off
Warranty Period	36 Months

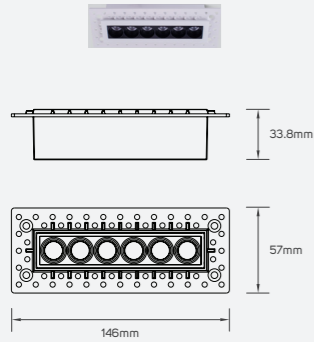

Cutting Size-120*32MM
LI614999 - LI615000 - LI615001 - LI615003 - LI615004 - LI615005

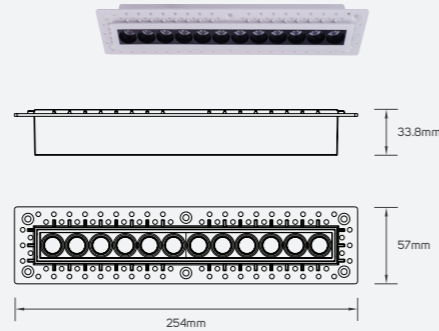

Cutting Size-228*32MM
LI615007 - LI615008 - LI615009 - LI615011 - LI615012 - LI615013

Family Product List

Code No.	Model No.	Power	Lumen	Efficacy	CCT	Saving Energy	Current	Equivalent
● 614999	ILS6WGD930WW01	6W	600lm	100lm/W	3000K	93%	50mA	83W
● 615000	ILS6WGD940NW01	6W	620lm	103.33lm/W	4000K	93%	50mA	86W
● 615001	ILS6WGD950DL01	6W	650lm	108.33lm/W	5000K	93%	50mA	90W
● 615003	ILS10WGD930WW01	10W	820lm	82lm/W	3000K	91%	83mA	112W
● 615004	ILS10WGD940NW01	10W	850lm	85lm/W	4000K	91%	83mA	116W
● 615005	ILS10WGD950DL01	10W	890lm	89lm/W	5000K	92%	83mA	121W
● 615007	ILS12WGD930WW01	12W	1150lm	95.83lm/W	3000K	92%	100mA	155W
● 615008	ILS12WGD940NW01	12W	1200lm	100lm/W	4000K	93%	100mA	162W
● 615009	ILS12WGD950DL01	12W	1270lm	105.83lm/W	5000K	93%	100mA	171W
● 615011	ILS20WGD930WW01	20W	1650lm	82.50lm/W	3000K	91%	150mA	220W
● 615012	ILS20WGD940NW01	20W	1720lm	86lm/W	4000K	91%	150mA	229W
● 615013	ILS20WGD950DL01	20W	1800lm	90lm/W	5000K	92%	150mA	240W

Led Recessed Linear Light Luminaire (Wall Washer)

Areas of Application



Prism

Technical Operating & Electrical Data

Input Voltage & Frequency	AC220-240V, 50/60Hz
IP Rating	IP20
Body Material	Aluminum + Plastic
Rated CRI	95
Body Color	White+Grey
Beam Angle	90°
Dimming	Non-Dimmable
Lifespan	30000H
Switching Cycle	10000x on/off
Warranty Period	36 Months

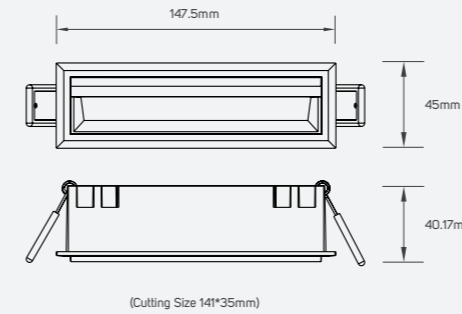

LI615015 - LI615016 - LI615017 - LI615019 - LI615020 - LI615021

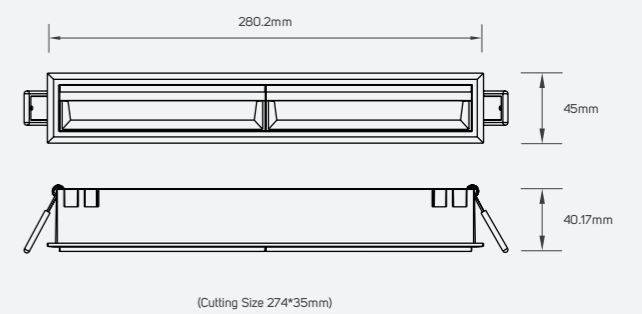

LI615023 - LI615024 - LI615025 - LI615027 - LI615028 - LI615029

Family Product List

Code No.	Model No.	Power	Lumen	Efficacy	CCT	Saving Energy	Current	Equivalent
● 615015	ILS6WGD930WW03	6W	415lm	69.17lm/W	3000K	83%	50mA	36W
● 615016	ILS6WGD940NW03	6W	425lm	79.83lm/W	4000K	84%	50mA	37W
● 615017	ILS6WGD950DL03	6W	445lm	74.17lm/W	5000K	84%	50mA	38W
● 615019	ILS9.5WGD930WW03	9.5W	640lm	67.37lm/W	3000K	81%	80mA	50W
● 615020	ILS9.5WGD940NW03	9.5W	660lm	69.47lm/W	4000K	81%	80mA	51W
● 615021	ILS9.5WGD950DL03	9.5W	705lm	74.21lm/W	5000K	82%	80mA	54W
● 615023	ILS11.5WGD930WW03	11.5W	800lm	69.57lm/W	3000K	81%	90mA	60W
● 615024	ILS11.5WGD940NW03	11.5W	830lm	72.17lm/W	4000K	81%	90mA	61W
● 615025	ILS11.5WGD950DL03	11.5W	865lm	75.22lm/W	5000K	82%	90mA	64W
● 615027	ILS19.5WGD930WW03	19.5W	1410lm	72.31lm/W	3000K	79%	150mA	94W
● 615028	ILS19.5WGD940NW03	19.5W	1460lm	74.87lm/W	4000K	80%	150mA	97W
● 615029	ILS19.5WGD950DL03	19.5W	1520lm	77.95lm/W	5000K	81%	150mA	100W



Led Recessed Spot Light Luminaire

Blaze

Technical Operating & Electrical Data

Input Voltage & Frequency	AC220-240V, 50/60Hz
IP Rating	IP20
Body Material	Aluminum + Plastic
Rated CRI	95
Body Color	White
Beam Angle	24°
Dimming	Non-Dimmable
Lifespan	30000H
Switching Cycle	10000x on/off
Warranty Period	36 Months

Areas of Application

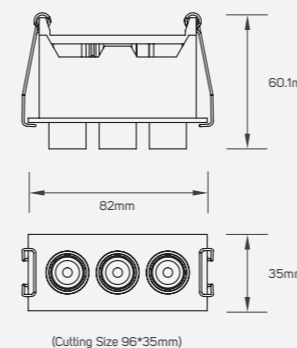
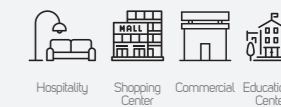

LI615031 - LI615032 - LI615033

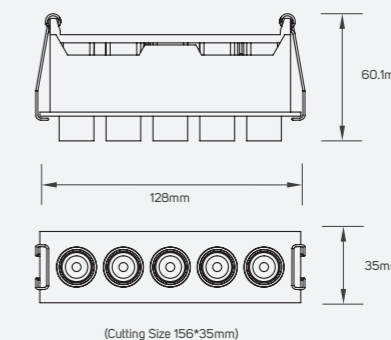

LI615035 - LI615036 - LI615037

Led Recessed Spot Light Luminaire

PRODUCT INFORMATION

- Modern looking, neat luminaire offering comfortable, good quality lighting and can also work as a design element.
- Ideal lighting in the non-working areas of professional spaces such as offices, educational institutes, and also the welcoming areas and entrances of retail spaces.
- ILLUS LED RECESSED LINEAR Luminaire gives the customer the flexibility to choose between 6 models based on their specific need with lumen package from 460lm to 820lm.

BENEFITS

- Clean and uniform light.
- Multiple application use.
- Easy to install and maintain.

FEATURES

- High CRI>95.
- Efficacy up to 83lm/w.
- Lifespan 30000H.
- Operating voltage AC220-240V.
- Non-Dimmable.

Family Product List

Code No.	Model No.	Power	Lumen	Efficacy	CCT	Saving Energy	Current	Equivalent
615031	ILS6WGSL930WW01	6W	460lm	76.67lm/W	3000K	91%	50mA	65W
615032	ILS6WGSL940NW01	6W	475lm	79.17lm/W	4000K	91%	50mA	67W
615033	ILS6WGSL950DL01	6W	500lm	83.33lm/W	5000K	91%	50mA	70W
615035	ILS10WGSL930WW01	10W	750lm	75lm/W	3000K	90%	70mA	103W
615036	ILS10WGSL940NW01	10W	780lm	78lm/W	4000K	91%	70mA	107W
615037	ILS10WGSL950DL01	10W	820lm	82lm/W	5000K	91%	70mA	112W



LED Recessed Linear Luminaire

Skyline

Areas of Application

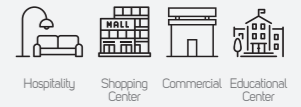

Technical Operating & Electrical Data

Input Voltage & Frequency	AC220-240V, 50/60Hz
IP Rating	IP20
Body Material	Aluminum
Rated CRI	80
Beam Angle	110°
Dimming	Non-Dimmable
Lifespan	40000h

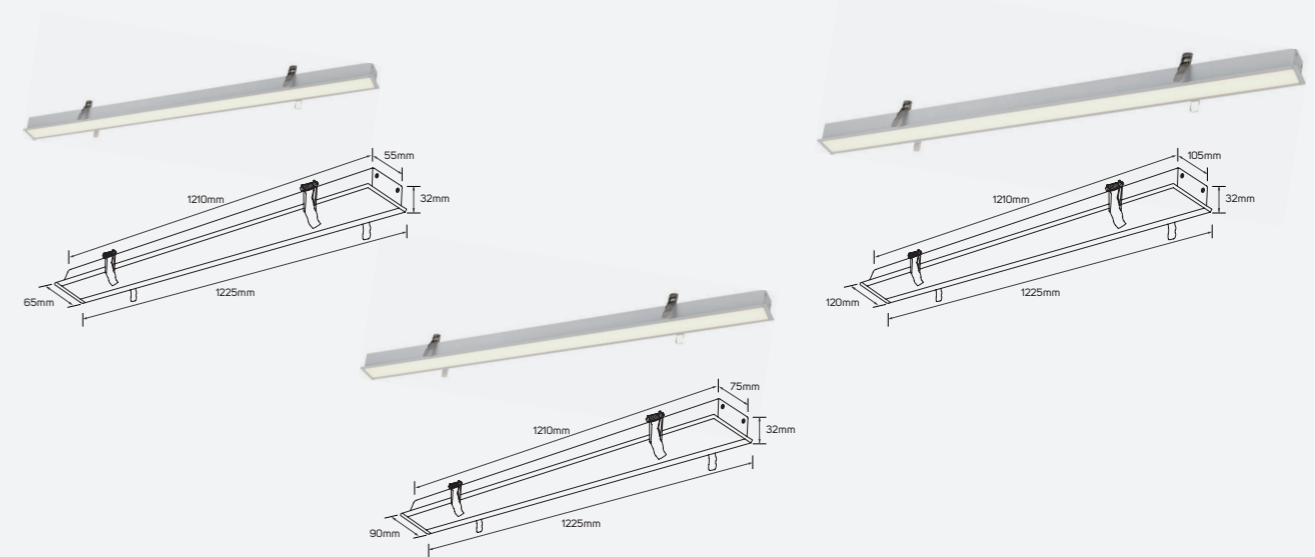

LED Recessed Linear Luminaire

PRODUCT INFORMATION

- Modern looking, neat luminaire offering comfortable, good quality lighting and can also work as a design element.
- Ideal lighting in the non-working areas of professional spaces such as offices, Educational institutes, and also the welcoming areas and entrances of retail spaces.
- ILLUS LED RECESSED LINEAR Luminaire gives the customer the flexibility to choose between 3 CCT based on their specific need with lumenpackage from 2060lm to 7200lm.

BENEFITS

- Uniform light.
- Multiple application use.
- Easy to install and maintain.

FEATURES

- High CRI>80.
- Efficacy up to 126lm/w.
- Long life span 40,000 hrs.
- Wide operating voltage AC220-240V.
- Non-Dimmable.

Family Product List

Code No.	Model No.	CCT	Power	Lumen	Efficacy	Cutting Size
612490	ILS57RLL830WW01	3000K	57W	6800lm	119lm/w	1210x105mm
612491	ILS57RLL857DL01	5700K	57W	7200lm	126lm/w	1210x105mm
612492	ILS57RLL840NW01	4000K	57W	7150lm	125lm/w	1210x105mm

Areas of Application

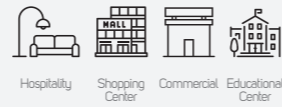

Geostar

Technical Operating & Electrical Data

Input Voltage & Frequency	AC220-240V, 50/60Hz
IP Rating	IP20
Body Material	Aluminum
Mounting Type	Recessed in Ceiling
Beam Angle	115°
Dimming	Non-Dimmable
Lifespan	30000H

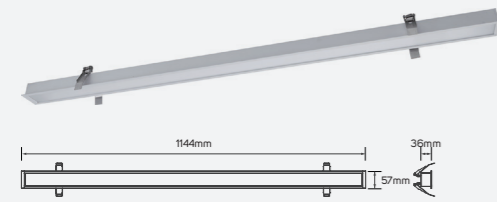

671059 - 671060 - 671061

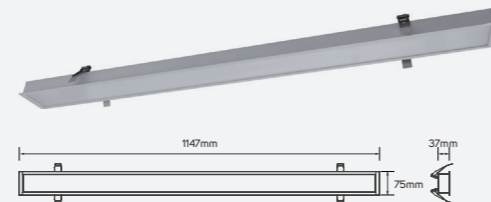

671062 - 671063 - 671064

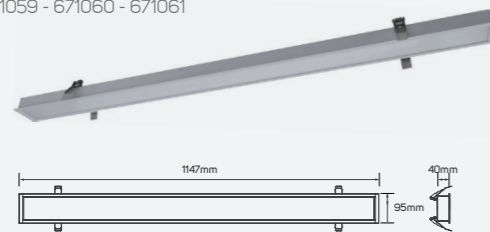

671065 - 671066 - 671067

Family Product List

Code No.	Model No.	CCT	Power	Lumen	Efficacy	Cutting Size
671059	ILS20RLL830WW02	3000K	20W	1700lm	85lm/w	1210x75mm
671060	ILS20RLL840NW02	4000K	20W	1800lm	90lm/w	1210x75mm
671061	ILS20RLL850DL02	5000K	20W	1850lm	92.5lm/w	1210x75mm
671062	ILS30RLL830WW01	3000K	30W	2500lm	83.33lm/w	1210x55mm
671063	ILS30RLL840NW01	4000K	30W	2700lm	90lm/w	1210x55mm
671064	ILS30RLL850DL01	5000K	30W	2750lm	91.67lm/w	1210x55mm
671065	ILS40RLL830WW02	3000K	40W	3300lm	82.5lm/w	1210x105mm
671066	ILS40RLL840NW02	4000K	40W	3500lm	87.5lm/w	1210x105mm
671067	ILS40RLL850DL02	5000K	40W	3600lm	90lm/w	1210x105mm





LED Recessed Linear Luminaire-Corner

LED Recessed Linear Luminaire (L-Shape)

Technical Operating & Electrical Data

Input Voltage & Frequency	AC220-240V, 50/60Hz
IP Rating	IP20
Body Material	Aluminum
Body Color	Matt White
Mounting Type	Recessed in Ceiling
Dimming	Non-Dimmable
Lifespan	30000H

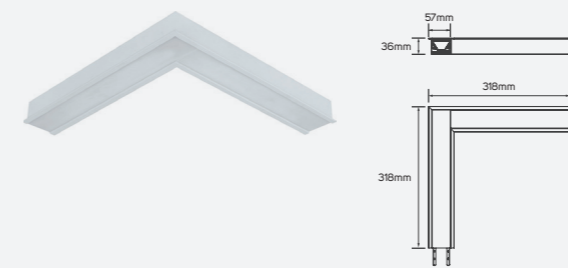

Diffuser

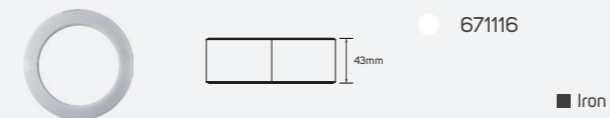

Iron

Family Product List

Code No.	Power	CCT	Lumen	Efficacy
671068	10.5W	3000K	1070lm	101.9lm/w
671069	10.5W	4000K	1100lm	104.76lm/w
671070	10.5W	5000K	1150lm	109.52lm/w

■ Aluminum
 IP 20 ▲ 110°
 □ AC220-240V ⌚ 30,000h

Connector

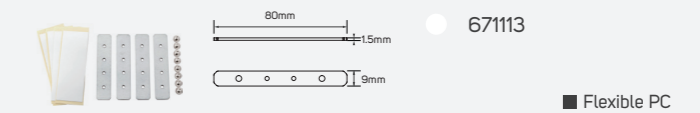

Flexible PC

LED Recessed Linear Luminaire-Corner

PRODUCT INFORMATION

- Modern looking, neat luminaire offering comfortable, good quality lighting and can also work as a design element.
- Ideal lighting in the non-working areas of professional spaces such as offices, educational institutes, and also the welcoming areas and entrances of retail spaces.
- ILLUS LED RECESSED LINEAR Luminaire (CORNER) gives the customer the flexibility to choose between 9 models based on their specific need with lumen package from 1070 lm to 2300 lm.

BENEFITS

- Clean and uniform light.
- Multiple application use.
- Easy to install and maintain.

FEATURES

- High CRI>80.
- Efficacy up to 115lm/w.
- Life span 30,000 hrs.
- Operating voltage AC220 – 240V.
- Non – dimmable.

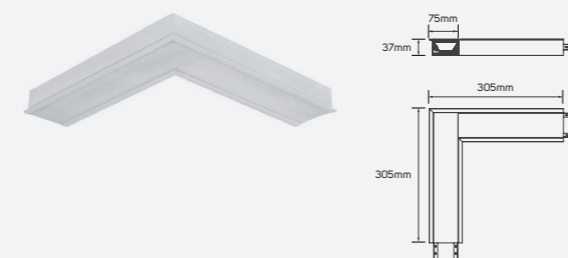

Diffuser

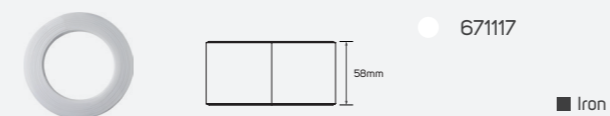

Iron

Family Product List

Code No.	Power	CCT	Lumen	Efficacy
671071	14W	3000K	1500lm	107.14lm/w
671072	14W	4000K	1570lm	112.14lm/w
671073	14W	5000K	1600lm	114.29lm/w

■ Aluminum
 IP 20 ▲ 115°
 □ AC220-240V ⌚ 30,000h

Connector

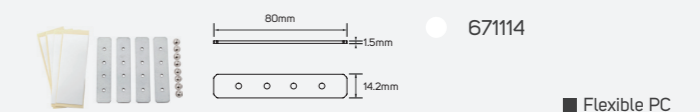

Flexible PC

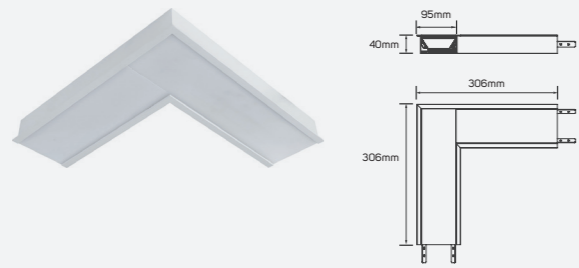

Diffuser

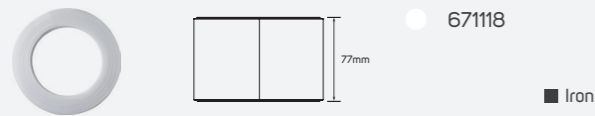

Family Product List

Code No.	Power	CCT	Lumen	Efficacy
----------	-------	-----	-------	----------

- 671074 20W 3000K 2100lm 105lm/w
- 671075 20W 4000K 2200lm 110lm/w
- 671076 20W 5000K 2300lm 115lm/w

Aluminum
 IP 20
 AC220-240V 115°
 30,000h

Connector

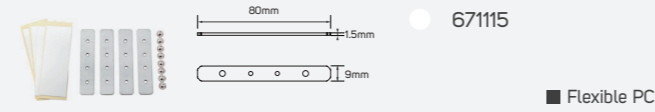

Family Product List

Code No.	Power	CCT	Lumen	Efficacy
----------	-------	-----	-------	----------

- 671077 10.5W 3000K 1000lm 95.24lm/w
- 671078 10.5W 4000K 1020lm 97.14lm/w
- 671079 10.5W 5000K 1040lm 99.05lm/w

Aluminum
 IP 20
 AC220-240V 110°
 30,000h

Connector

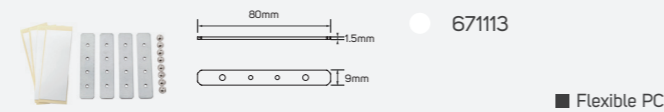

Family Product List

Code No.	Power	CCT	Lumen	Efficacy
----------	-------	-----	-------	----------

- 671080 14.5W 3000K 1350lm 93.1lm/w
- 671081 14.5W 4000K 1470lm 101.38lm/w
- 671082 14.5W 5000K 1500lm 103.45lm/w

Aluminum
 IP 20
 AC220-240V 110°
 30,000h

Connector

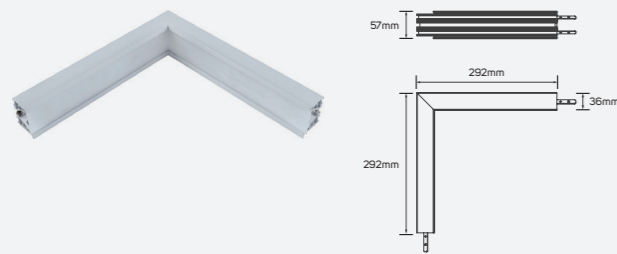
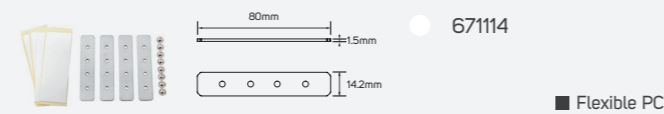

Diffuser

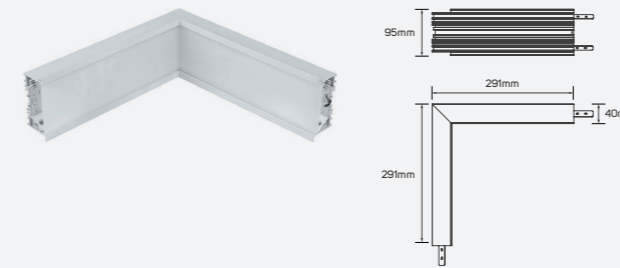
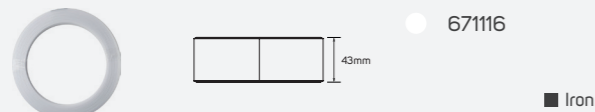

Diffuser

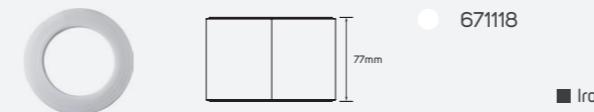

Family Product List

Code No.	Power	CCT	Lumen	Efficacy
----------	-------	-----	-------	----------

- 671083 20W 3000K 1980lm 99lm/w
- 671084 20W 4000K 2040lm 102lm/w
- 671085 20W 5000K 2100lm 105lm/w

Aluminum
 IP 20
 AC220-240V 110°
 30,000h

Connector

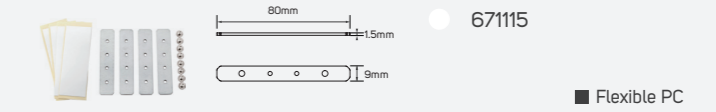

Family Product List

Code No.	Power	CCT	Lumen	Efficacy
----------	-------	-----	-------	----------

- 671086 11W 3000K 1060lm 96.36lm/w
- 671087 11W 4000K 1090lm 99.09lm/w
- 671088 11W 5000K 1110lm 100.91lm/w

Aluminum
 IP 20
 AC220-240V 140°
 30,000h

Connector

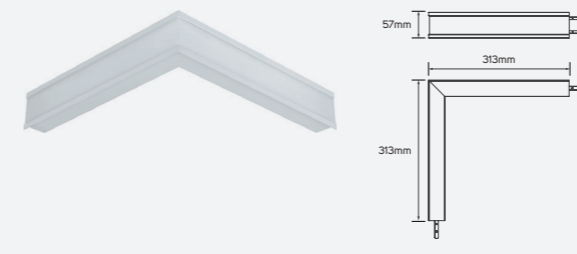
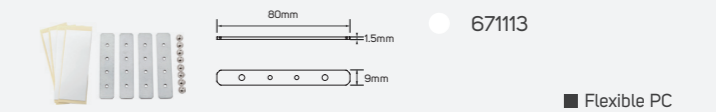

Diffuser

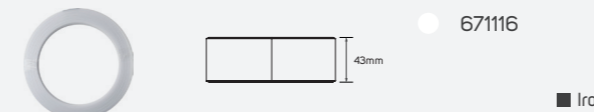

Family Product List

Code No.	Power	CCT	Lumen	Efficacy
----------	-------	-----	-------	----------

- 671089 14.5W 3000K 1570lm 108.28lm/w
- 671090 14.5W 4000K 1600lm 110.34lm/w
- 671091 14.5W 5000K 1650lm 113.79lm/w

Aluminum
 IP 20
 AC220-240V 140°
 30,000h

Connector

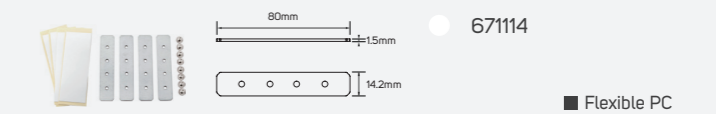

Diffuser

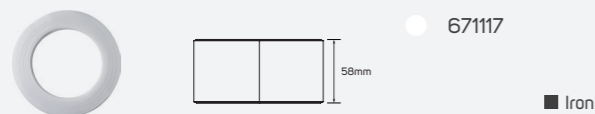

Diffuser

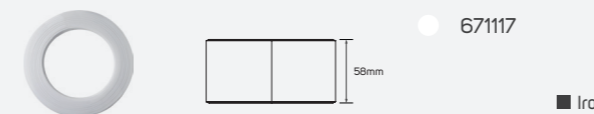

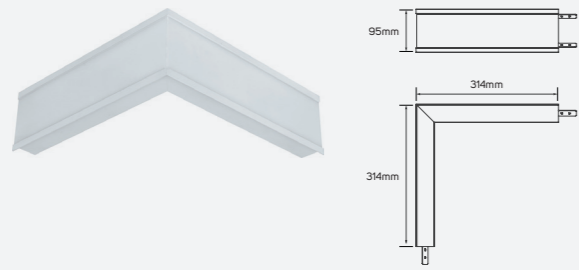

Diffuser



● 671118
■ Iron

Family Product List

Code No.	Power	CCT	Lumen	Efficacy
----------	-------	-----	-------	----------

- 671092 20.5W 3000K 2100lm 102.44lm/w
- 671093 20.5W 4000K 2200lm 107.32lm/w
- 671094 20.5W 5000K 2250lm 109.76lm/w

■ Aluminum
IP 20 \angle 140°
AC220-240V \odot 30,000h

Connector

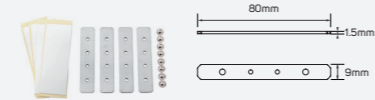

● 671115
■ Flexible PC

LED Recessed Linear Luminaire-Corner

LED Recessed Linear Luminaire (T-Shape)

Technical Operating & Electrical Data

Input Voltage & Frequency AC220-240V, 50/60Hz
IP Rating IP20
Body Material Aluminum
Body Color Matt White
Mounting Type Recessed in Ceiling
Dimming Non-Dimmable
Lifespan 30000H

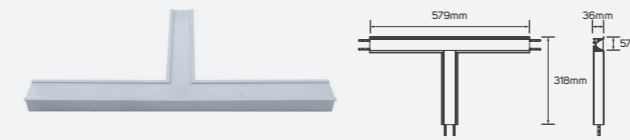

Diffuser



● 671116
■ Iron

Family Product List

Code No.	Power	CCT	Lumen	Efficacy
----------	-------	-----	-------	----------

- 671095 14.5W 3000K 1570lm 108.28lm/w
- 671096 14.5W 4000K 1600lm 110.34lm/w
- 671097 14.5W 5000K 1650lm 113.79lm/w

■ Aluminum
IP 20 \angle 110°
AC220-240V \odot 30,000h

Connector

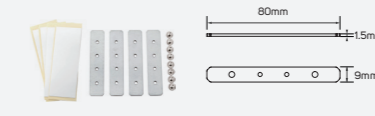

● 671113
■ Flexible PC

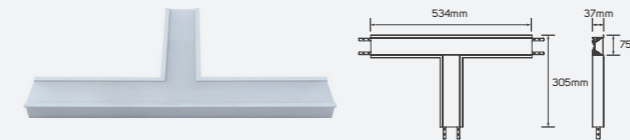

Diffuser



● 671117
■ Iron

Family Product List

Code No.	Power	CCT	Lumen	Efficacy
----------	-------	-----	-------	----------

- 671098 21.5W 3000K 2250lm 104.65lm/w
- 671099 21.5W 4000K 2350lm 109.3lm/w
- 671100 21.5W 5000K 2450lm 113.95lm/w

■ Aluminum
IP 20 \angle 110°
AC220-240V \odot 30,000h

Connector

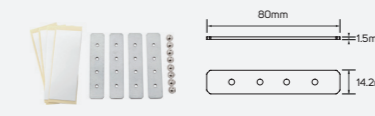

● 671114
■ Flexible PC

LED Recessed Linear Luminaire-Corner

LED Recessed Linear Luminaire (X-Shape)

Technical Operating & Electrical Data

Input Voltage & Frequency	AC220-240V, 50/60Hz
IP Rating	IP20
Body Material	Aluminum
Body Color	Matt White
Mounting Type	Recessed in Ceiling
Dimming	Non-Dimmable
Lifespan	30000H

Family Product List

Code No.	Power	CCT	Lumen	Efficacy
----------	-------	-----	-------	----------

- 671101 30W 3000K 3150lm 105lm/w
- 671102 30W 4000K 3200lm 106.67lm/w
- 671103 30W 5000K 3250lm 108.33lm/w

■ Aluminum

IP 20

110°

AC220-240V

30,000h

Connector

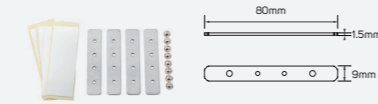

● 671115

■ Flexible PC

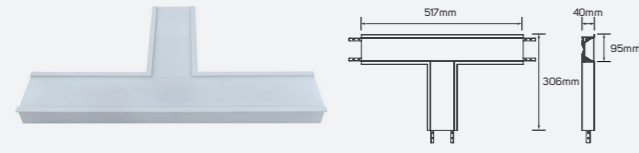

Diffuser

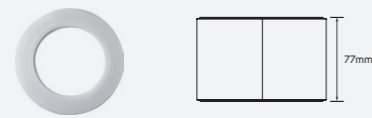

● 671118

■ Iron

Family Product List

Code No.	Power	CCT	Lumen	Efficacy
----------	-------	-----	-------	----------

- 671104 20W 3000K 2110lm 105.5lm/w
- 671105 20W 4000K 2200lm 110lm/w
- 671106 20W 5000K 2280lm 114lm/w

■ Aluminum

IP 20

110°

AC220-240V

30,000h

Connector

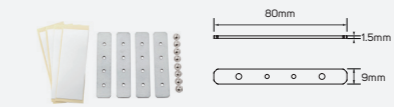

● 671113

■ Flexible PC

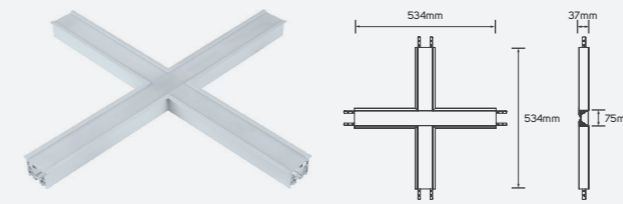

Diffuser



● 671116

■ Iron

Family Product List

Code No.	Power	CCT	Lumen	Efficacy
----------	-------	-----	-------	----------

- 671107 30W 3000K 3300lm 110lm/w
- 671108 30W 4000K 3400lm 113.33lm/w
- 671109 30W 5000K 3480lm 116lm/w

■ Aluminum

IP 20

110°

AC220-240V

30,000h

Connector

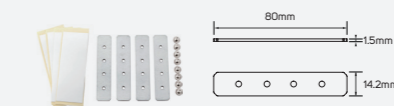

● 671114

■ Flexible PC

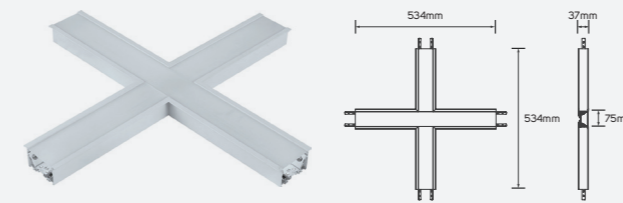

Diffuser



● 671117

■ Iron

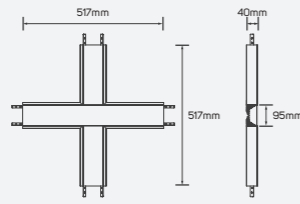
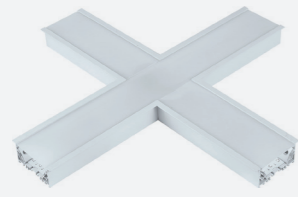

Family Product List

Code No.	Power	CCT	Lumen	Efficacy
671110	40W	3000K	4200lm	105lm/w
671111	40W	4000K	4500lm	112.5lm/w
671112	40W	5000K	4600lm	115lm/w

■ Aluminum
 IP 20 ▽ 110°
 AC220-240V ⌚ 30,000h

Diffuser



● 671118

■ Iron

Connector



● 671115

■ Flexible PC

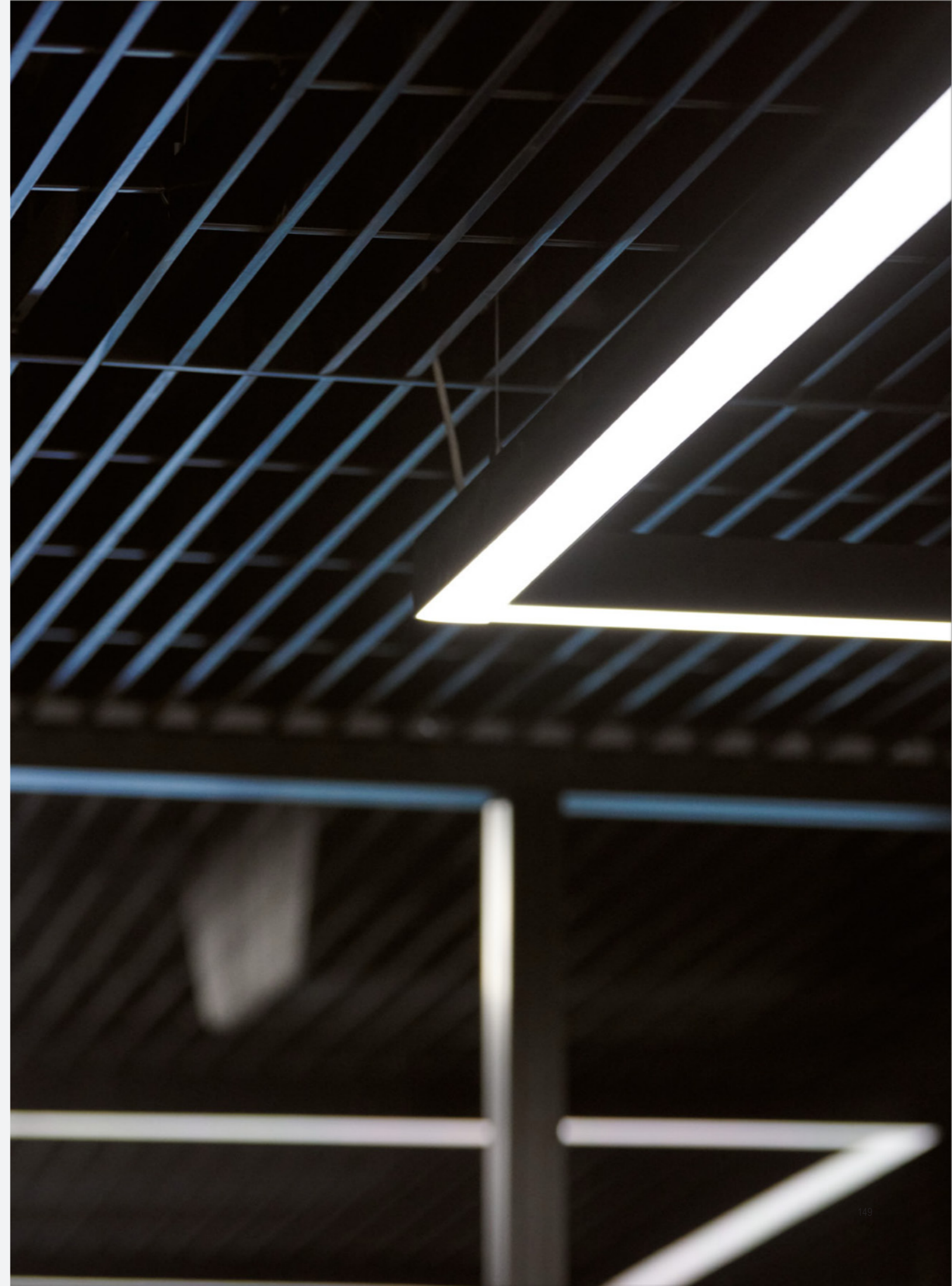



Led Pendant Linear Light Luminaire

Zen

Technical Operating & Electrical Data

Input Voltage & Frequency	AC220-240V, 50/60Hz
IP Rating	IP20
Body Material	Aluminum + PC
Rated CRI	95
Body Color	Sandy Black/White
Rated Power	23W
Dimming	Non-Dimmable
Lifespan	30000H
Switching Cycle	100000x on/off
Warranty Period	36 Months

Areas of Application

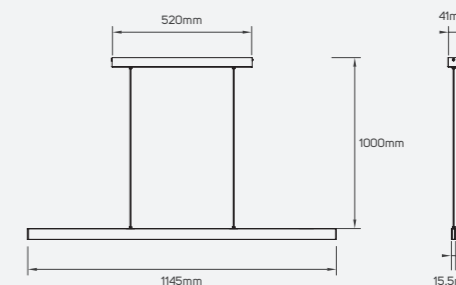
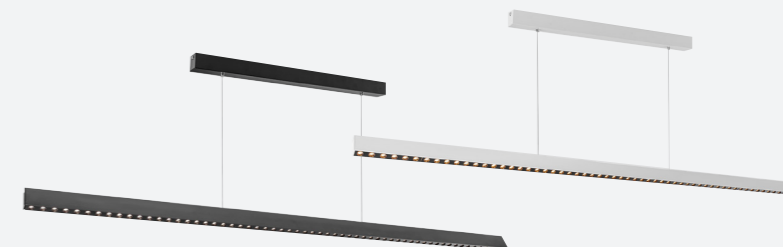
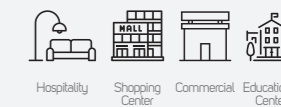

Led Pendant Linear Light Luminaire

PRODUCT INFORMATION

- Modern looking, neat luminaire offering comfortable, good quality lighting and can also work as a design element.
- Ideal lighting in the non-working areas of professional spaces such as offices, educational institutes, and also the welcoming areas and entrances of retail spaces.
- ILLUS LED PENDANT LINEAR LIGHT Luminaire gives the customer the flexibility to choose between 6 models based on their specific need with lumen package from 2200lm to 2350lm.

BENEFITS

- Clean and uniform light.
- Multiple application use.
- Easy to install and maintain.

FEATURES

- High CRI>95.
- Efficacy up to 102lm/w.
- Long lifespan 30000H.
- Operating Voltage AC220-240V.
- Non-Dimmable.

Family Product List

Code No.	Model No.	Beam Angle	Lumen	Efficacy	CCT	Saving Energy	Current	Equivalent
● 615106	ILS23PLL930WW01	40°	2200lm	95.65lm/W	3000K	92%	100mA	292W
● 615107	ILS23PLL940NW01	40°	2250lm	97.83lm/W	4000K	92%	100mA	298W
● 615108	ILS23PLL950DL01	40°	2300lm	100lm/W	5000K	92%	100mA	305W
○ 615109	ILS23PLL930WW02	40°	2250lm	97.83lm/W	3000K	92%	100mA	298W
○ 615110	ILS23PLL940NW02	40°	2300lm	100lm/W	4000K	92%	100mA	305W
○ 615111	ILS23PLL950DL02	40°	2350lm	102.17lm/W	5000K	93%	100mA	312W

LED Pendant Linear Luminaire

Tido

Technical Operating & Electrical Data

Input Voltage & Frequency	AC220-240V, 50/60Hz
IP Rating	IP20
Material	Aluminum
Beam Angle	115°
Rated CRI	80
Dimming	Non-Dimmable
Fixed or Adjustable	Adjustable
Lifespan	30000H



Areas of Application

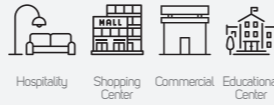

Dimensions

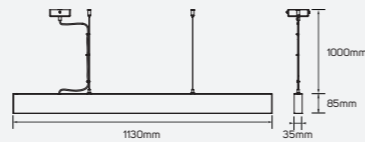

Family Product List

Code No.	Model No.	Power	Lumen	Efficacy	CCT	Body Color
671119	ILS14.5PLL830WW01	14.5W	1070lm	73.79lm/w	3000K	aluminum
671120	ILS14.5PLL840NW01	14.5W	1150lm	79.31lm/w	4000K	aluminum
671121	ILS14.5PLL850DL01	14.5W	1200lm	82.76lm/w	5000K	aluminum
671122	ILS14.5PLL830WW02	14.5W	1150lm	79.31lm/w	3000K	matt white
671123	ILS14.5PLL840NW02	14.5W	1250lm	86.21lm/w	4000K	matt white
671124	ILS14.5PLL850DL02	14.5W	1300lm	89.66lm/w	5000K	matt white
671125	ILS14.5PLL830WW03	14.5W	950lm	65.52lm/w	3000K	matt black
671126	ILS14.5PLL840NW03	14.5W	1050lm	72.41lm/w	4000K	matt black
671127	ILS14.5PLL850DL03	14.5W	1100lm	75.86lm/w	5000K	matt black

LED Pendant Linear Luminaire

Xenon

Technical Operating & Electrical Data

Input Voltage & Frequency	AC220-240V, 50/60Hz
IP Rating	IP20
Material	Aluminum
Beam Angle	115°
Rated CRI	80
Dimming	Non-Dimmable
Fixed or Adjustable	Adjustable
Lifespan	30000H



Areas of Application

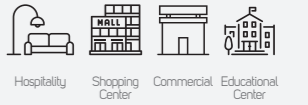

Dimensions

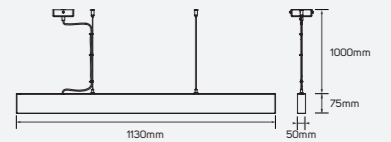

Family Product List

Code No.	Model No.	Power	Lumen	Efficacy	CCT	Body Color
671128	ILS30PLL830WW01	30W	2400lm	80lm/w	3000K	Silver
671129	ILS30PLL840NW01	30W	2550lm	85lm/w	4000K	Silver
671130	ILS30PLL850DL01	30W	2650lm	88.33lm/w	5000K	Silver
671131	ILS30PLL830WW02	30W	2550lm	85lm/w	3000K	matt white
671132	ILS30PLL840NW02	30W	2700lm	90lm/w	4000K	matt white
671133	ILS30PLL850DL02	30W	2800lm	93.33lm/w	5000K	matt white
671134	ILS30PLL830WW03	30W	2300lm	76.67lm/w	3000K	matt black
671135	ILS30PLL840NW03	30W	2550lm	85lm/w	4000K	matt black
671136	ILS30PLL850DL03	30W	2600lm	86.67lm/w	5000K	matt black



LED Pendant Linear Light Luminaire (CCT & Power Changeable)

Areas of Application

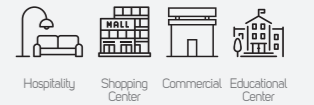

Tido

Technical Operating & Electrical Data

Input Voltage & Frequency	AC220-240V, 50/60Hz (DC104V T-L-X Shapes)
IP Rating	IP20
Material	Aluminum
CCT	CCT Tunable (3000K-4000K-5000K)
Ambient Temperature	40°C
Rated CRI	95
IEC Classification	Class I
Dimming	Non-Dimmable
Lifespan	30000H
Switching Cycle	100,000x on/off
Warranty Period	60 Months

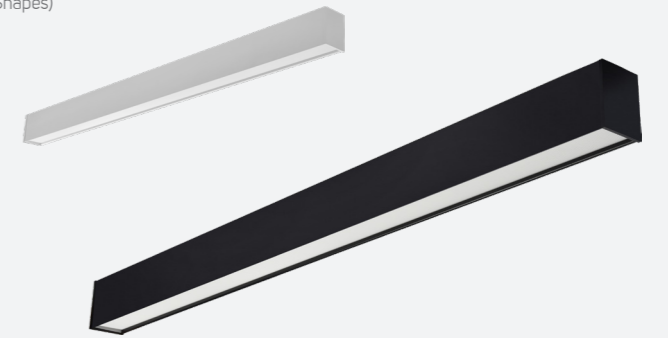

Dimensions Options

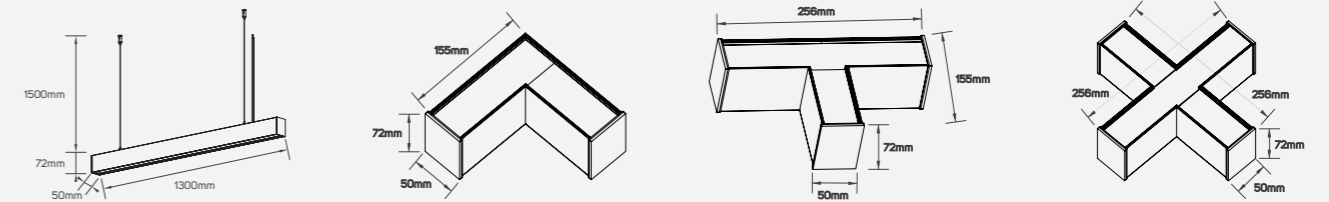

LED Pendant Linear Light Luminaire (CCT & Power Changeable)

PRODUCT INFORMATION

- Illus LED pendant lights, featuring adjustable wattage and CCT (Correlated Color Temperature), provide enhanced flexibility, mood control, and energy efficiency, enabling users to tailor lighting to various tasks and atmospheres.
- These fixtures usually include built-in switches, enabling users to adjust both color temperature (warm, neutral, or cool) and brightness without the need for additional hardware or complicated technical modifications.*
- The LED pendant light is available in 2 models, featuring LED connectors in T-, L-, and X-types, with lumen outputs ranging from 1000lm to 5000lm at 3000K.

BENEFITS

- Adjust from warm (3000K) to neutral (4000K) or cool white (5000K) for any mood or task.
- Ideal for open-plan spaces, like kitchen islands or dining areas that shift from meals to work.
- Adjustable wattage lets you optimize light output for any room, avoiding over- or under-lighting.
- LED technology saves energy, and adjustable power settings further reduce consumption.

FEATURES

- Flicker Free.
- High CRI≥95.
- Saving Energy.
- Efficacy up to 128lm/W.

Family Product List

Code No.	Model No.	Power	Changeable Power	Lumen	Efficacy	D.F	P.F	Current
● 615738	ILSCPPLLCCTB01	40W	24-32-40W	5000lm	125lm/W	0.97	0.95	180mA
● 615739	ILSCPPLLCCTW01	40W	24-32-40W	5000lm	125lm/W	0.97	0.95	180mA
● 615740	ILSCPPLLCCTB01	8.5W	5-6.5-8.5W	1000lm	117.65lm/W	1	1	81mA
● 615741	ILSCPPLLCCTW01	8.5W	5-6.5-8.5W	1000lm	117.65lm/W	1	1	81mA
● 615742	ILSCPPLLCCTB01	12.5W	8-10-12.5W	1600lm	128lm/W	1	1	120mA
● 615743	ILSCPPLLCCTW01	12.5W	8-10-12.5W	1600lm	128lm/W	1	1	120mA
● 615744	ILSCPPLXCCTB01	18W	11-14-18W	2000lm	111.11lm/W	1	1	170mA
● 615745	ILSCPPLXCCTW01	18W	11-14-18W	2000lm	111.11lm/W	1	1	170mA

Suspension Accessories

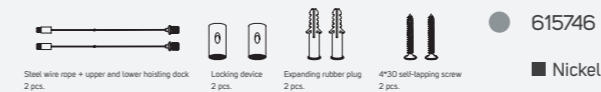

Fixing Accessories



Fixing Accessories

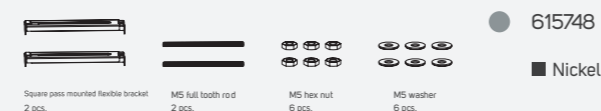

Fixing Accessories

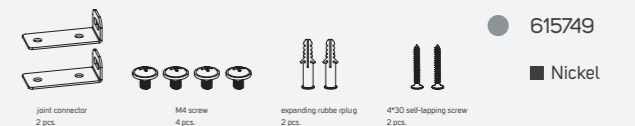

Connector

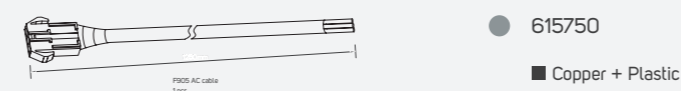

Fixing Connectors

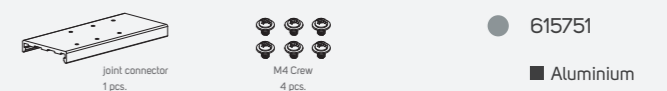



LED Pendant Linear Light Luminaire Series

Tido

Technical Operating & Electrical Data

Input Voltage & Frequency	AC220-240V, 50/60Hz
IP Rating	IP20
Material	Galvanized Steel
CCT	CCT Tunable (3000K-4000K-5000K)
Ambient Temperature	45°C
Rated CRI	95
Beam Angle	90°
Dimming	Non-Dimmable
Lifespan	30000H
Switching Cycle	100,000x on/off
Warranty Period	36 Months

Areas of Application

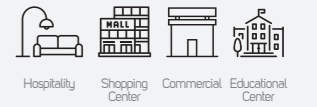

Dimensions

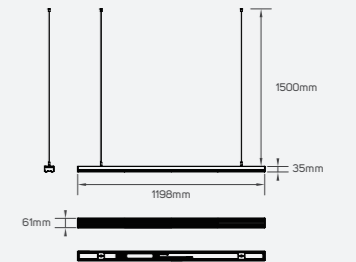

LED Pendant Linear Light Luminaire Series

PRODUCT INFORMATION

- The Illus linear LED pendant luminaire offers exceptional versatility with adjustable power and selectable CCT, allowing you to customize light output and color temperature to suit a wide range of applications and user preferences.
- These fixtures deliver energy efficiency of LED technology while offering superior flexibility and precise control.
- The LED linear pendant luminaire consists of 4 models with lumen packages from 5000lm to 7000lm at 3000K.

BENEFITS

- Selectable wattage settings allow easy adjustment of brightness to suit different spaces and activities, from task lighting to ambient illumination.
- Brightness can be selected to adapt to the changing needs or interior designs.
- One fixture replaces multiple models, reducing inventory complexity while ensuring the right solution is always available.
- It ensures seamless integration with existing lighting for a cohesive, aesthetically pleasing space.
- With an extended lifespan, these luminaires minimize maintenance and replacement costs versus traditional lighting sources.

FEATURES

- Flicker Free.
- High CRI≥95.
- Energy Saving.
- Non-Dimmable.
- Long Lifespan 30000H.
- Efficacy up to 117lm/W.
- Operating Voltage AC220-240V.

Family Product List

Code No.	Power	Changeable Power	Lumen	Efficacy	D.F	P.F	Current
● 615729	50W	28-36-42-50W	5700lm	114lm/W	0.98	0.97	220mA
● 615730	50W	28-36-42-50W	5700lm	114lm/W	0.98	0.97	220mA
● 615731	60W	36-44-52-60W	7000lm	117lm/W	0.98	0.97	250mA
● 615732	60W	36-44-52-60W	7000lm	117lm/W	0.98	0.97	250mA

Starry Romance

Areas of Application

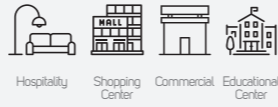

Technical Operating & Electrical Data

Input Voltage & Frequency	AC220-240V, 50/60Hz
IP Rating	IP20
Material	Aluminum
Beam Angle	36°
Rated CRI	95
Dimming	Dimmable
Lifespan	30000H



Dimensions

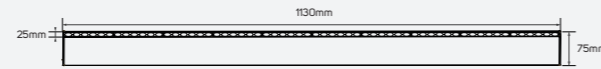

Family Product List

Code No.	Model No.	Power	Lumen	Efficacy	CCT	Body Color
● 614228	ILS20DPLL930WWMB01	20W	2000lm	100lm/W	3000K	Matt black
● 614229	ILS20DPLL940NWMB01	20W	2250lm	112.5lm/W	4000K	Matt black
● 614230	ILS20DPLL930WWMW01	20W	2000lm	100lm/W	3000K	Matt white
● 614231	ILS20DPLL940NWMW01	20W	2250lm	112.5lm/W	4000K	Matt white
● 614232	ILS30DPLL930WWMB01	30W	2850lm	95lm/W	3000K	Matt black
● 614233	ILS30DPLL940NWMB01	30W	3150lm	105lm/W	4000K	Matt black
● 614234	ILS30DPLL930WWMW01	30W	2850lm	95lm/W	3000K	Matt white
● 614235	ILS30DPLL940NWMW01	30W	3150lm	105lm/W	4000K	Matt white





LED Pendant Linear Luminaire-Corner

LED Pendant Linear Luminaire (L-Shape)

Technical Operating & Electrical Data

Input Voltage & Frequency	AC220-240V, 50/60Hz
IP Rating	IP20
Body Material	Aluminum
Beam Angle	110°
Fixed or Adjustable	Adjustable
Dimming	Non-Dimmable
Lifespan	30000H

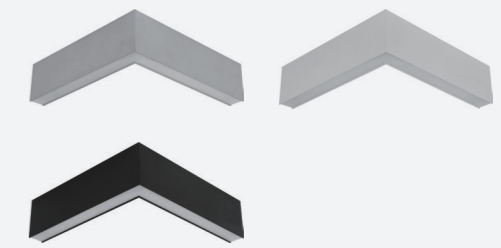

Dimensions

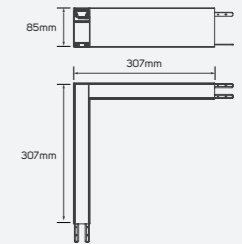

Diffuser

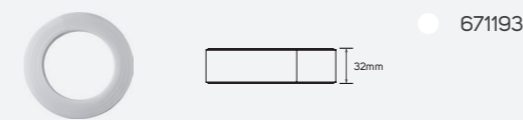

■ Iron

Connector

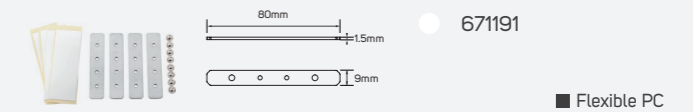

■ Flexible PC

Connector

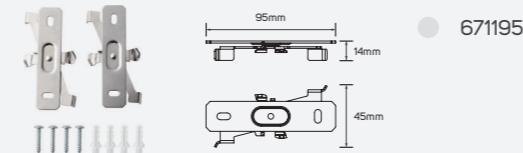

■ Flexible PC

Connector

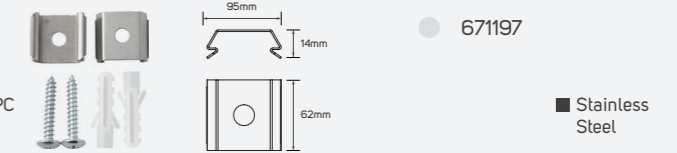

■ Stainless Steel

Connector

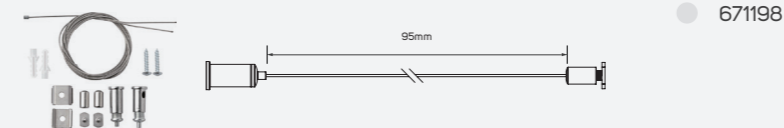

■ Stainless Steel+Iron

LED Pendant Linear Luminaire-Corner

PRODUCT INFORMATION

- Modern looking, neat luminaire offering comfortable, good quality lighting and can also work as a design element.
- Ideal lighting in the non-working areas of professional spaces such as offices, educational institutes, and also the welcoming areas and entrances of retail spaces.
- ILLUS LED PENDANT LINEAR Luminaire gives the customer the flexibility to choose between 9 models based on their specific need with lumen package from 630 lm to 790 lm.

BENEFITS

- Uniform light.
- Multiple application use.
- Easy to install and maintain.

FEATURES

- High CRI>90.
- Efficacy to 105lm/w.
- Long life span 30,000 hrs.
- Wide operating voltage AC220-240V.
- Non-dimmable.

Family Product List

Code No.	Model No.	Power	Lumen	Efficacy	CCT	Body Color
● 671137	ILS7.5PLLL830WW01	7.5W	700lm	93.33lm/w	3000K	aluminum
● 671138	ILS7.5PLLL840NW01	7.5W	730lm	97.33lm/w	4000K	aluminum
● 671139	ILS7.5PLLL850DL01	7.5W	740lm	98.67lm/w	5000K	aluminum
● 671140	ILS7.5PLLL830WW02	7.5W	750lm	100lm/w	3000K	matt white
● 671141	ILS7.5PLLL840NW02	7.5W	780lm	104lm/w	4000K	matt white
● 671142	ILS7.5PLLL850DL02	7.5W	790lm	105.33lm/w	5000K	matt white
● 671143	ILS7.5PLLL830WW03	7.5W	630lm	84lm/w	3000K	matt black
● 671144	ILS7.5PLLL840NW03	7.5W	660lm	88lm/w	4000K	matt black
● 671145	ILS7.5PLLL850DL03	7.5W	670lm	89.33lm/w	5000K	matt black

LED Pendant Linear Luminaire (L-Shape)

Technical Operating & Electrical Data

Input Voltage & Frequency	AC220-240V, 50/60Hz
IP Rating	IP20
Body Material	Aluminum
Beam Angle	110°
Fixed or Adjustable	Adjustable
Dimming	Non-Dimmable
Lifespan	30000H

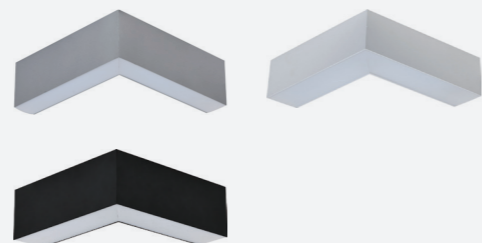

Dimensions

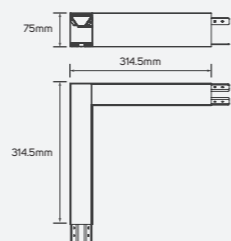

Diffuser



● 671194

■ Iron

Connector

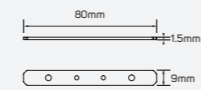

● 671192

■ Flexible PC

Connector

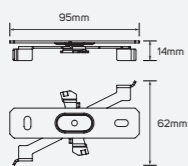

● 671196

■ Flexible PC

Connector

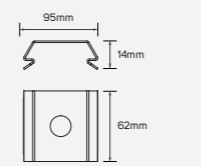

● 671197

■ Stainless Steel

Connector

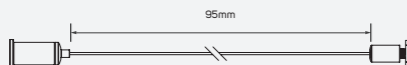

● 671198

■ Stainless Steel+Iron

Family Product List

Code No.	Model No.	Power	Lumen	Efficacy	CCT	Body Color
● 671146	ILS14PLLL830WW01	14W	1500lm	107.14lm/w	3000K	aluminum
● 671147	ILS14PLLL840NW01	14W	1600lm	114.29lm/w	4000K	aluminum
● 671148	ILS14PLLL850DL01	14W	1650lm	117.86lm/w	5000K	aluminum
● 671149	ILS14PLLL830WW02	14W	1540lm	110lm/w	3000K	matt white
● 671150	ILS14PLLL840NW02	14W	1620lm	115.71lm/w	4000K	matt white
● 671151	ILS14PLLL850DL02	14W	1650lm	117.86lm/w	5000K	matt white
● 671152	ILS14PLLL830WW03	14W	1420lm	101.43lm/w	3000K	matt black
● 671153	ILS14PLLL840NW03	14W	1500lm	107.14lm/w	4000K	matt black
● 671154	ILS14PLLL850DL03	14W	1550lm	110.71lm/w	5000K	matt black



LED Pendant Linear Luminaire (T-Shape)

Technical Operating & Electrical Data

Input Voltage & Frequency	AC220-240V, 50/60Hz
IP Rating	IP20
Body Material	Aluminum
Beam Angle	110°
Fixed or Adjustable	Adjustable
Dimming	Non-Dimmable
Lifespan	30000H

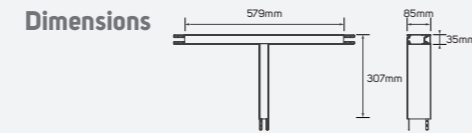
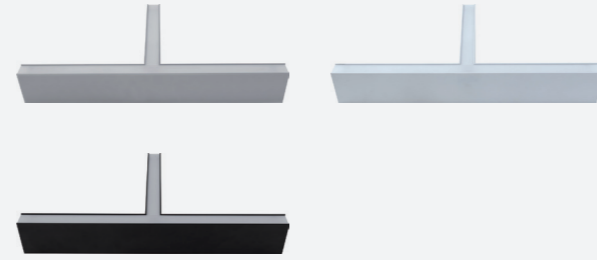

Diffuser

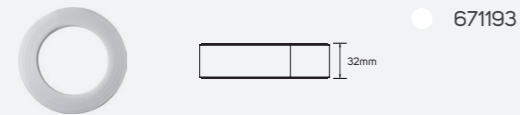

Connector

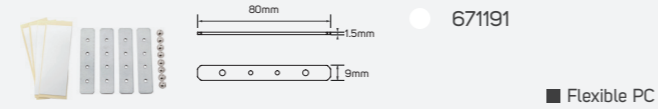

Connector

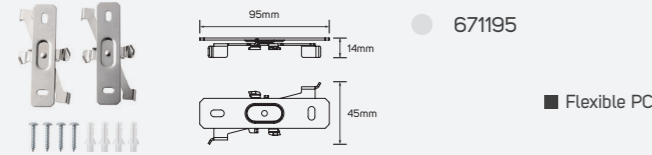

Connector

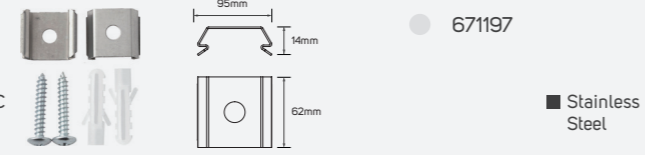

Connector

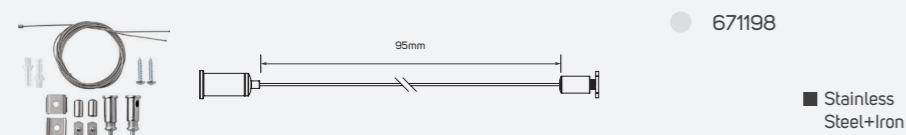

Family Product List

Code No.	Model No.	Power	Lumen	Efficacy	CCT	Body Color
● 671155	ILS10.5PLLT830WW01	10.5W	1000lm	95.24lm/w	3000K	aluminum
● 671156	ILS10.5PLLT840NW01	10.5W	1060lm	100.95lm/w	4000K	aluminum
● 671157	ILS10.5PLLT850DL01	10.5W	1100lm	104.76lm/w	5000K	aluminum
● 671158	ILS10.5PLLT830WW02	10.5W	1040lm	99.05lm/w	3000K	mat white
● 671159	ILS10.5PLLT840NW02	10.5W	1100lm	104.76lm/w	4000K	mat white
● 671160	ILS10.5PLLT850DL02	10.5W	1140lm	108.57lm/w	5000K	mat white
● 671161	ILS10.5PLLT830WW03	10.5W	900lm	85.71lm/w	3000K	mat black
● 671162	ILS10.5PLLT840NW03	10.5W	960lm	91.43lm/w	4000K	mat black
● 671163	ILS10.5PLLT850DL03	10.5W	1000lm	95.24lm/w	5000K	mat black

LED Pendant Linear Luminaire (T-Shape)

Technical Operating & Electrical Data

Input Voltage & Frequency	AC220-240V, 50/60Hz
IP Rating	IP20
Body Material	Aluminum
Beam Angle	110°
Fixed or Adjustable	Adjustable
Dimming	Non-Dimmable
Lifespan	30000H

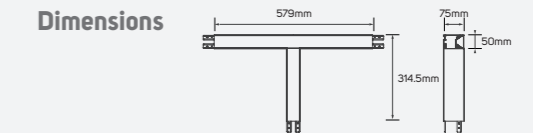
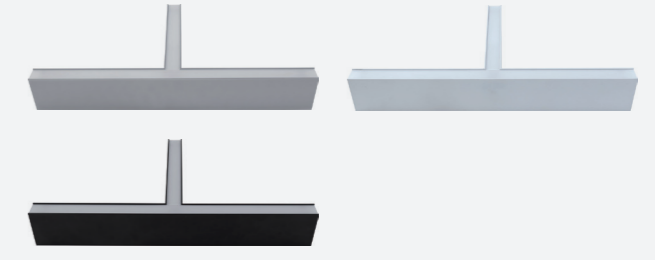

Diffuser

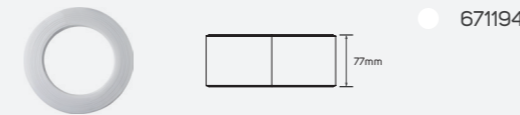

Connector

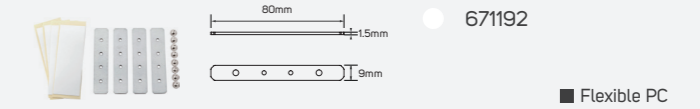

Connector

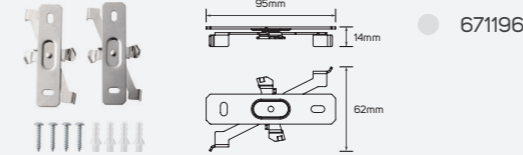

Connector

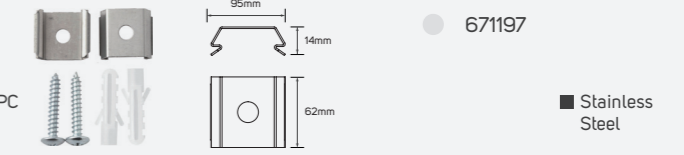

Connector

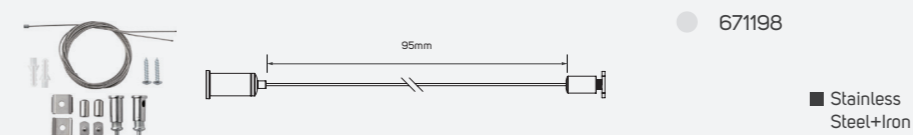

Family Product List

Code No.	Model No.	Power	Lumen	Efficacy	CCT	Body Color
● 671164	ILS21.5PLLT830WW01	21.5W	2100lm	97.67lm/w	3000K	aluminum
● 671165	ILS21.5PLLT840NW01	21.5W	2250lm	104.65lm/w	4000K	aluminum
● 671166	ILS21.5PLLT850DL01	21.5W	2350lm	109.3lm/w	5000K	aluminum
● 671167	ILS21.5PLLT830WW02	21.5W	2250lm	104.65lm/w	3000K	mat white
● 671168	ILS21.5PLLT840NW02	21.5W	2450lm	113.95lm/w	4000K	mat white
● 671169	ILS21.5PLLT850DL02	21.5W	2540lm	118.14lm/w	5000K	mat white
● 671170	ILS21.5PLLT830WW03	21.5W	2050lm	95.35lm/w	3000K	mat black
● 671171	ILS21.5PLLT840NW03	21.5W	2250lm	104.65lm/w	4000K	mat black
● 671172	ILS21.5PLLT850DL03	21.5W	2350lm	109.3lm/w	5000K	mat black

LED Pendant Linear Luminaire (X-Shape)

Technical Operating & Electrical Data

Input Voltage & Frequency	AC220-240V, 50/60Hz
IP Rating	IP20
Body Material	Aluminum
Beam Angle	110°
Fixed or Adjustable	Adjustable
Dimming	Non-Dimmable
Lifespan	30000H

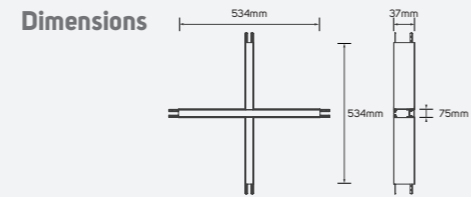
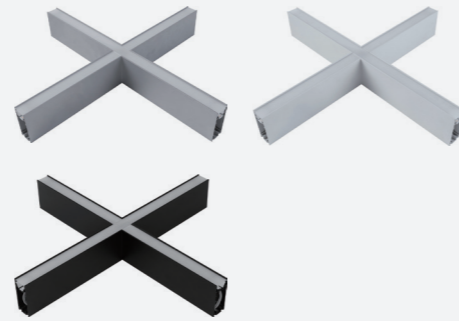

Diffuser

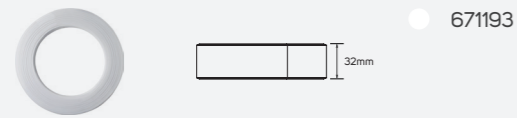

Connector

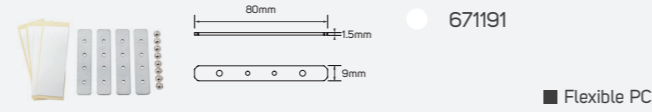

Connector

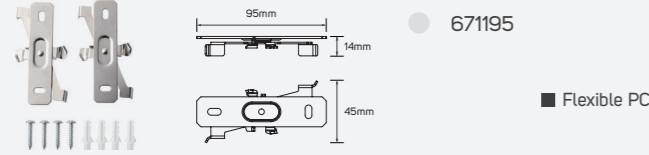

Connector

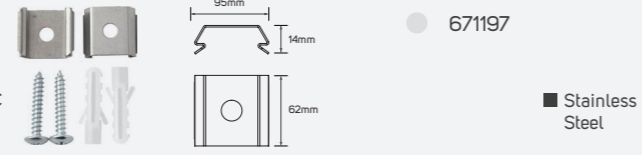

Connector

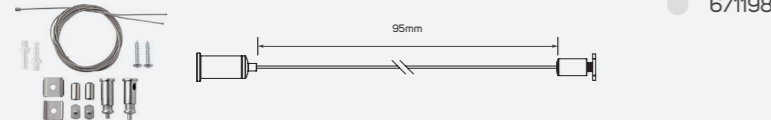

Family Product List

Code No.	Model No.	Power	Lumen	Efficacy	CCT	Body Color
671173	ILS14PLLX830WW01	14W	1400lm	100lm/w	3000K	Silver
671174	ILS14PLLX840NW01	14W	1500lm	107.14lm/w	4000K	Silver
671175	ILS14PLLX850DL01	14W	1550lm	110.71lm/w	5000K	Silver
671176	ILS14PLLX830WW02	14W	1500lm	107.14lm/w	3000K	matt white
671177	ILS14PLLX840NW02	14W	1600lm	114.29lm/w	4000K	matt white
671178	ILS14PLLX850DL02	14W	1650lm	117.86lm/w	5000K	matt white
671179	ILS14PLLX830WW03	14W	1250lm	89.29lm/w	3000K	matt black
671180	ILS14PLLX840NW03	14W	1350lm	96.43lm/w	4000K	matt black
671181	ILS14PLLX850DL03	14W	1400lm	100lm/w	5000K	matt black

LED Pendant Linear Luminaire (X-Shape)

Technical Operating & Electrical Data

Input Voltage & Frequency	AC220-240V, 50/60Hz
IP Rating	IP20
Body Material	Aluminum
Beam Angle	110°
Fixed or Adjustable	Adjustable
Dimming	Non-Dimmable
Lifespan	30000H

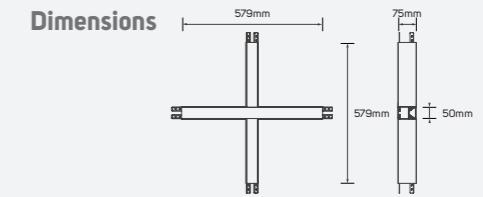
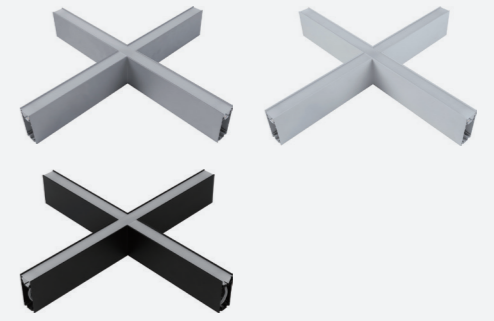

Diffuser

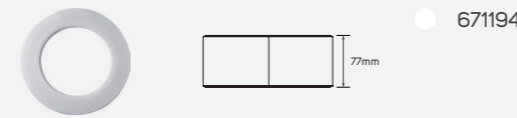

Connector

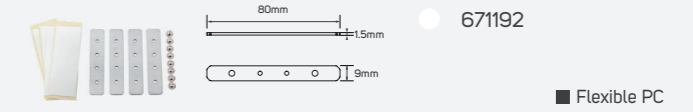

Connector

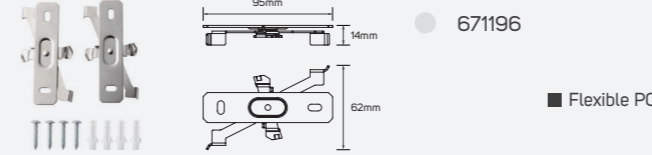

Connector

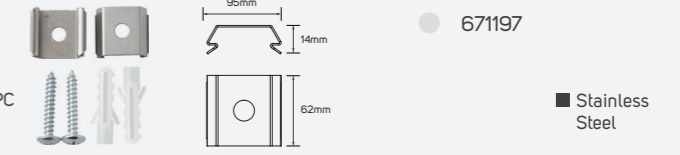

Connector

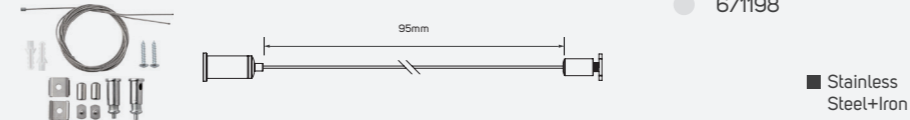

Family Product List

Code No.	Model No.	Power	Lumen	Efficacy	CCT	Body Color
671182	ILS30PLLX830WW01	30W	3250lm	108.33lm/w	3000K	Silver
671183	ILS30PLLX840NW01	30W	3450lm	115lm/w	4000K	Silver
671184	ILS30PLLX850DL01	30W	3550lm	118.33lm/w	5000K	Silver
671185	ILS30PLLX830WW02	30W	3250lm	108.33lm/w	3000K	matt white
671186	ILS30PLLX840NW02	30W	3450lm	115lm/w	4000K	matt white
671187	ILS30PLLX850DL02	30W	3550lm	118.33lm/w	5000K	matt white
671188	ILS30PLLX830WW03	30W	3050lm	101.67lm/w	3000K	matt black
671189	ILS30PLLX840NW03	30W	3200lm	106.67lm/w	4000K	matt black
671190	ILS30PLLX850DL03	30W	3300lm	110lm/w	5000K	matt black



A photograph of a modern interior space featuring a track lighting system. The ceiling is white and has two parallel black tracks installed. Several black cylindrical track lights are mounted on the tracks, some of which are illuminated. In the background, there are windows, a white air conditioning unit, and a doorway. The overall aesthetic is clean and minimalist.

Track

Artique

Technical Operating & Electrical Data

Input Voltage & Frequency	AC220-240V, 50/60Hz
IP Rating	IP20
Mounting Type	Recessed

Areas of Application

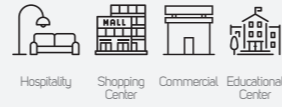

Dimensions Options

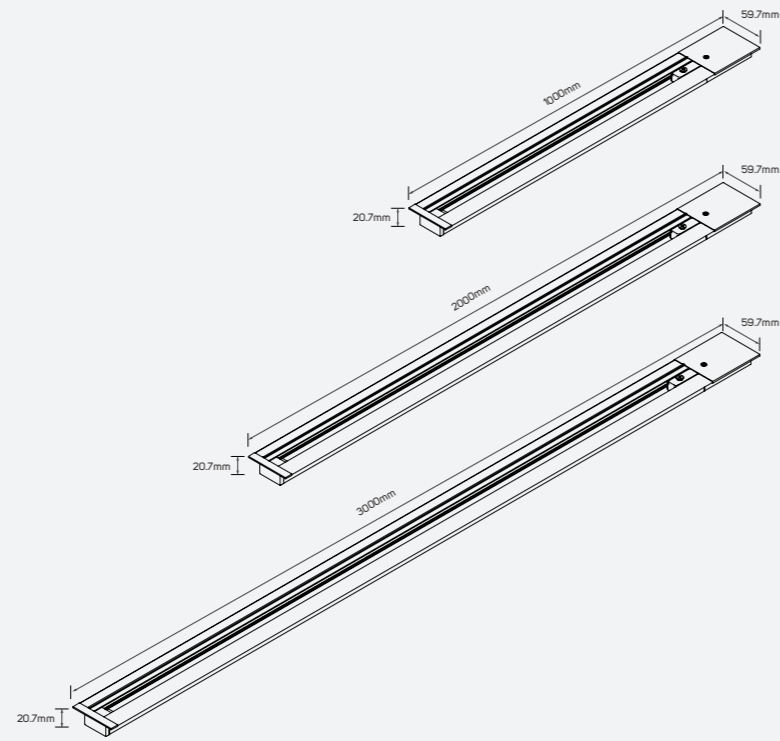

Connector Specifications

Connector

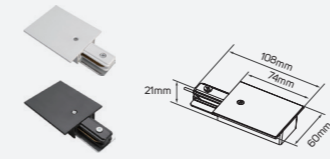

- 671205 Max.10A
- 671206 Max.10A
- PC+Copper

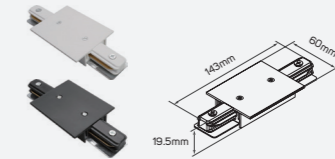

- 671207 Max.10A
- 671208 Max.10A
- PC+Copper

Connector

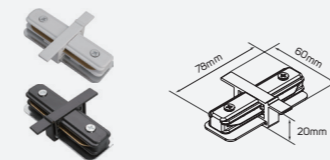

- 671209 Max.10A
- 671210 Max.10A
- PC+Copper

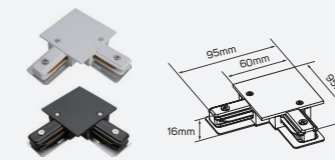

- 671211 Max.10A
- 671212 Max.10A
- PC+Copper

Connector

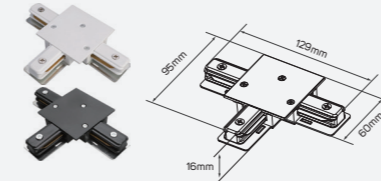

- 671213 Max.10A
- 671214 Max.10A
- PC+Copper

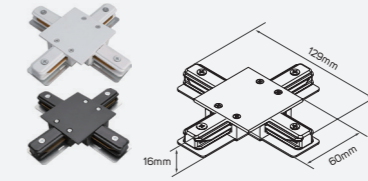

- 671215 Max.10A
- 671216 Max.10A
- PC+Copper

Connector

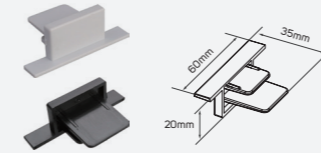

- 671217 Max.10A
- 671218 Max.10A
- PC

Family Product List

■ Aluminum+PVC+Copper

IP 20 AC220-240V

Code No.	Current Capacity
● 671199	Max.10A
● 671200	Max.10A
● 671201	Max.10A
● 671202	Max.10A
● 671203	Max.10A
● 671204	Max.10A

Artique

Technical Operating & Electrical Data

Input Voltage & Frequency	AC220-240V, 50/60Hz
IP Rating	IP20
Mounting Type	Recessed

Areas of Application

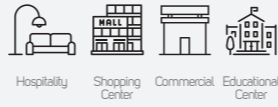

Dimensions Options

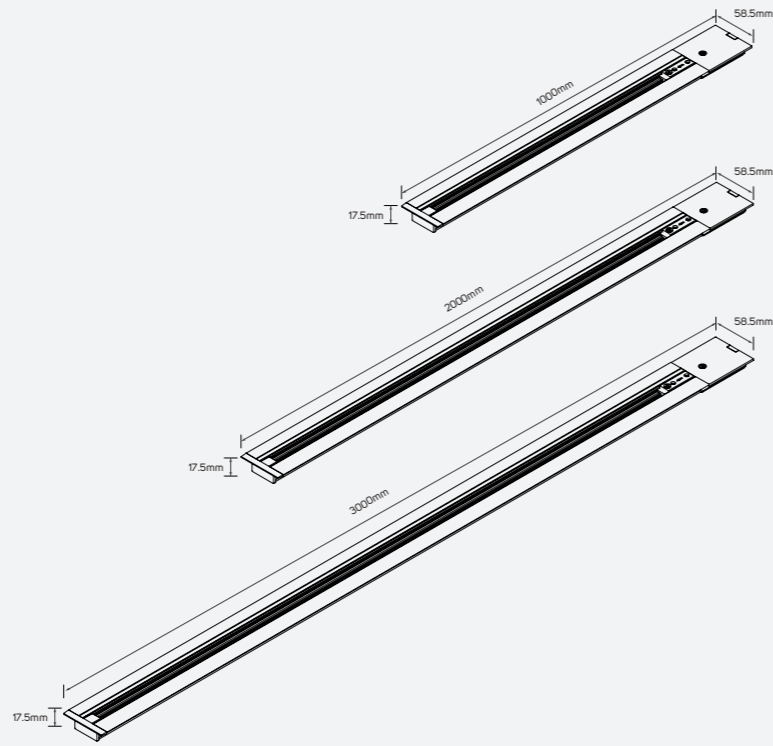

Connector Specifications

Connector

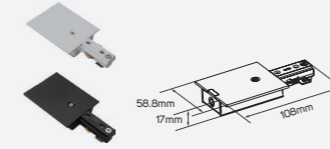

- 671225 Max.10A
- 671226 Max.10A
- PC+Copper

Connector

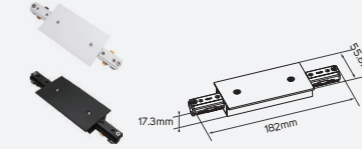

- 671227 Max.10A
- 671228 Max.10A
- PC+Copper

Connector

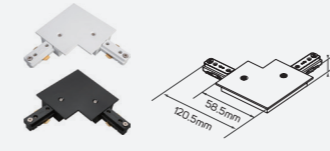

- 671229 Max.10A
- 671230 Max.10A
- PC+Copper

Connector

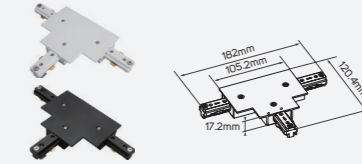

- 671231 Max.10A
- 671232 Max.10A
- PC+Copper

Connector

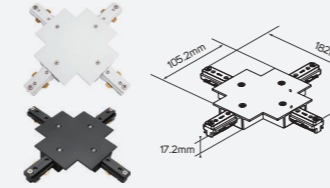

- 671233 Max.10A
- 671234 Max.10A
- PC+Copper

Connector

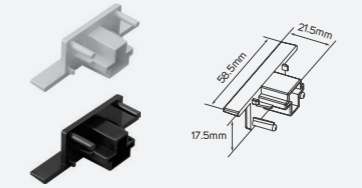

- 671235 Max.10A
- 671236 Max.10A
- PC

Family Product List

■ Aluminum+PVC+Pure Copper

IP 20 AC220-240V

Code No.	Current Capacity
● 671219	Max.10A
● 671220	Max.10A
● 671221	Max.10A
● 671222	Max.10A
● 671223	Max.10A
● 671224	Max.10A

Track

Galactic

Technical Operating & Electrical Data

Input Voltage & Frequency	AC220-240V, 50/60Hz
IP Rating	IP20
Mounting Type	Recessed

Areas of Application

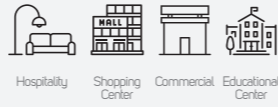

Dimensions Options

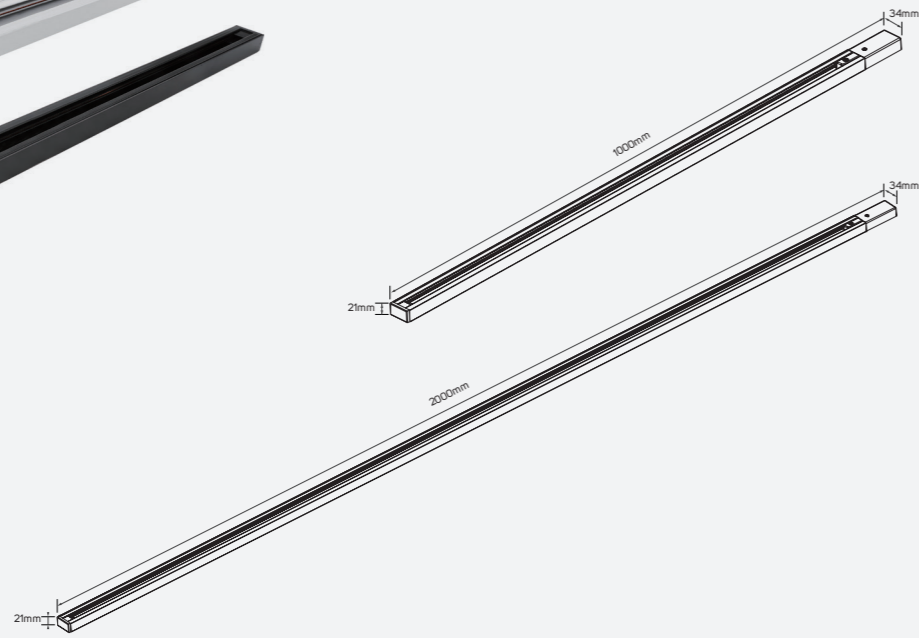

Connector Specifications

Connector

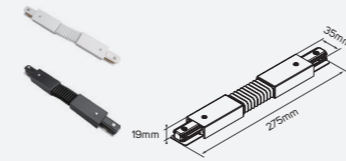

- 612468 Max.10A
- 612469 Max.10A
- PC+Copper

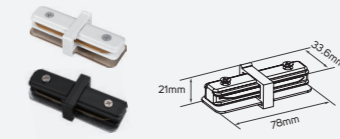

- 611455 Max.10A
- 611456 Max.10A
- PC+Copper

Connector

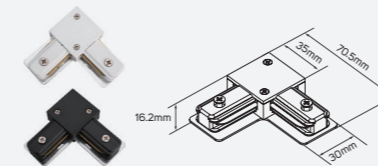

- 611457 Max.10A
- 611458 Max.10A
- PC+Copper

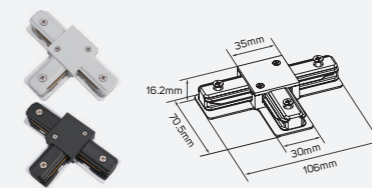

- 611459 Max.10A
- 611460 Max.10A
- PC+Copper

Connector

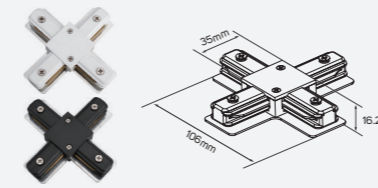

- 611461 Max.10A
- 611462 Max.10A
- PC+Copper

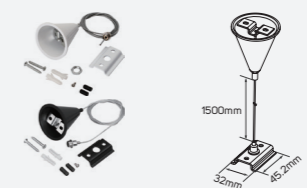

- 611731 Max.10A
- 611732 Max.10A
- Aluminum +PC+Steel

Family Product List

■ Aluminum+PVC+Pure Copper

IP 20 AC220-240V

Code No.	Current Capacity
● 612470	Max.10A
● 612471	Max.10A
● 612472	Max.10A
● 612473	Max.10A

Galactic

Technical Operating & Electrical Data

Input Voltage & Frequency	AC220-240V, 50/60Hz
IP Rating	IP20
Mounting Type	Recessed

Areas of Application

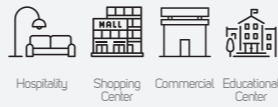

Connector Specifications

Connector

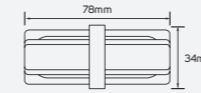

- 613354 Max.10A
- 613355 Max.10A
- Copper + Plastic

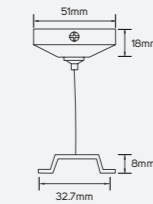

- 613356 Max.10A
- 613357 Max.10A
- Aluminum +PC+Steel

Connector

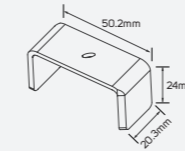

- 613362 Max.10A
- Metal

Dimensions Options

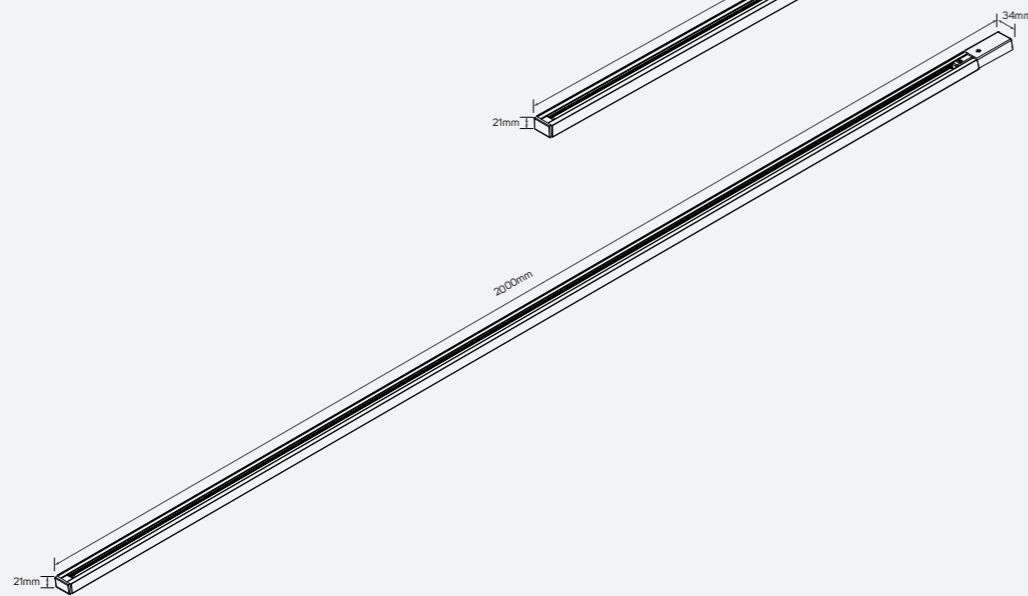
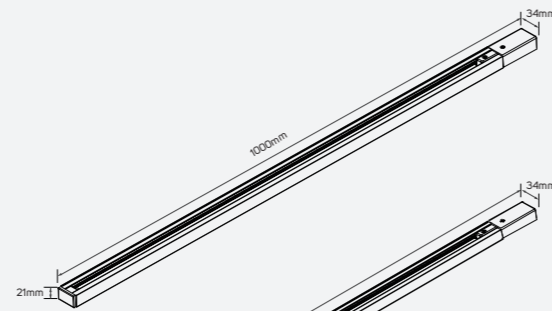

Family Product List

■ Aluminum+PVC+Pure Copper

IP 20 AC220-240V

Code No.	Current Capacity
● 613358	Max.10A
● 613359	Max.10A
● 613360	Max.10A
● 613361	Max.10A



LED Lamp

- LED Module Luminaire (MR11)
- LED Module Luminaire (MR16)
- LED AR111
- LED 50 Module (GU10)
- LED 35 Module (MR11)
- LED G9 Lamp
- LED GU10 Lamp
- LED Smart Lamp
- LED Non-Directional Lamp
- LED Filament Lamp
- Led Filament Lamp E27
- Led Filament Lamp E14
- LED Filament Lamp (PIR Sensor)
- LED Filament Lamp (Microwave Sensor)
- LED T8 Glass Tube Light



LED Module Luminaire (MR11)

PRODUCT INFORMATION

- Suitable for a series of lighting applications in office, retail and general area lighting.
- Available in a wide variety of lumen packs, cut out size and color temperature.
- ILLUS LED MODULE Luminaire (MR11) gives the customer the flexibility to choose between 8 models based on their specific need with lumen package from 380lm to 660lm.

BENEFITS

- Compact design for better integration with the building.
- Comfortable light with high efficiency.
- Reliable performance for indoor applications.

FEATURES

- High CRI>95.
- Efficacy up to 83lm/w.
- Long lifespan 30,000H
- Operating voltage AC220-240V .
- Non-Dimmable.

LED Module Luminaire (MR11)

Vela

Technical Operating & Electrical Data

Input Voltage & Frequency	AC220-240V, 50/60Hz
IP Rating	IP44
Body Material	Aluminum
Rated CRI	95
Lamp Type	Direct
Beam Angle	36°
Body Color	Dark Grey
Dimming	Non-Dimmable
Lifespan	30000H
Switching Cycle	100000x on/off
Warranty Period	36 Months

Areas of Application

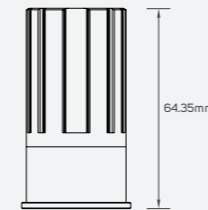
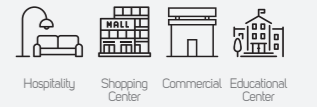

LI614968 - LI614969 - LI614954 - LI614970

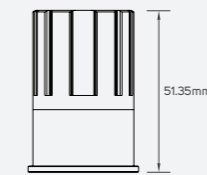

LI614972 - LI614973 - LI614955 - LI614974

Family Product List

Code No.	Model No.	Power	Lumen	Efficacy	CCT	Current	Saving Energy	Equivalent
● 614968	ILS5.5MR11M927WW01	5.5W	380lm	69.09lm/W	2700K	52mA	90%	55W
● 614969	ILS5.5MR11M930WW01	5.5W	390lm	70.91lm/W	3000K	52mA	90%	56W
● 614954	ILS5.5MR11M935WW01	5.5W	405lm	73.64lm/W	3500K	52mA	91%	58W
● 614970	ILS5.5MR11M940NW01	5.5W	425lm	77.27lm/W	4000K	52mA	91%	60W
● 614972	ILS8MR11M927WW01	8W	580lm	72.50lm/W	2700K	70mA	90%	81W
● 614973	ILS8MR11M930WW01	8W	600lm	75lm/W	3000K	70mA	90%	83W
● 614955	ILS8MR11M935WW01	8W	630lm	78.75lm/W	3500K	70mA	91%	87W
● 614974	ILS8MR11M940NW01	8W	660lm	82.50lm/W	4000K	70mA	91%	91W

Lens Options

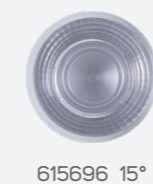
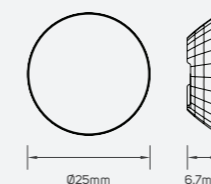

615696 15°

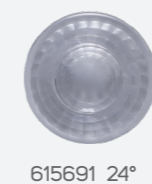

615691 24°



615692 60°



LED Module Luminaire (MR16)

Areas of Application

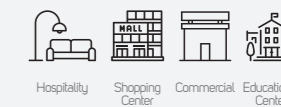

Orion

Technical Operating & Electrical Data

Input Voltage & Frequency	AC220-240V, 50/60Hz
IP Rating	IP44
Body Material	Aluminum
Rated CRI	95
Lamp Type	Direct
Beam Angle	36°
Body Color	Dark Grey
Dimming	Non-Dimmable
Lifespan	30000H
Switching Cycle	100000x on/off
Warranty Period	36 Months

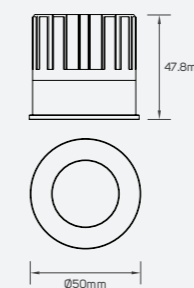
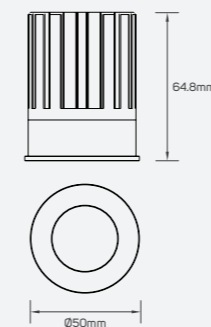

LI614960 - LI614961 - LI614953 - LI614962 - LI614963

LI614956 - LI614957 - LI614952 - LI614958 - LI614959

LED Module Luminaire (MR16)

PRODUCT INFORMATION

- Suitable for a series of lighting applications in office, retail and general area lighting.
- Available in a wide variety of lumen packs, cut out size and color temperature.
- ILLUS LED MODULE Luminaire (MR16) gives the customer the flexibility to choose between 10 models based on their specific need with lumen package from 910lm to 1400lm.

BENEFITS

- Compact design for better integration with the building.
- Comfortable light with high efficiency.
- Reliable performance for indoor applications.

FEATURES

- High CRI>95.
- Efficacy up to 105 lm/w.
- Long lifespan 30,000H.
- Operating voltage AC220-240V.
- Non-Dimmable.

Family Product List

Code No.	Model No.	Power	Lumen	Efficacy	CCT
● 614956	ILS10MR16M927WW02	10W	910lm	91lm/W	2700K
● 614957	ILS10MR16M930WW02	10W	930lm	93lm/W	3000K
● 614952	ILS10MR16M935WW02	10W	960lm	96lm/W	3500K
● 614958	ILS10MR16M940NW02	10W	1000lm	100lm/W	4000K
● 614959	ILS10MR16M950DL02	10W	1050lm	105lm/W	5000K
● 614960	ILS15MR16M927WW01	15W	1200lm	80lm/W	2700K
● 614961	ILS15MR16M930WW01	15W	1230lm	82lm/W	3000K
● 614953	ILS15MR16M935WW01	15W	1270lm	84.67lm/W	3500K
● 614962	ILS15MR16M940NW01	15W	1330lm	88.67lm/W	4000K
● 614963	ILS15MR16M950DL01	15W	1400lm	93.33lm/W	5000K

Lens Options

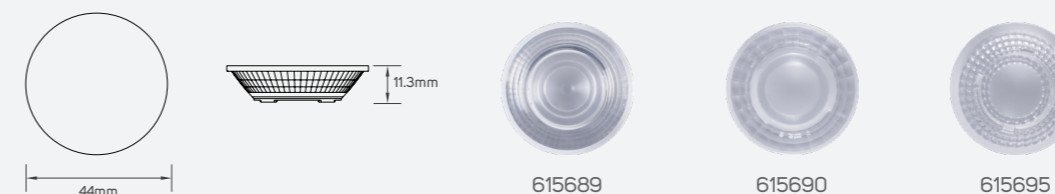



LED AR111

Refined Brilliance

Areas of Application

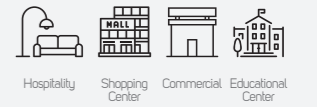

Technical Operating & Electrical Data

Input Voltage & Frequency	AC220-240V, 50/60Hz
Cap Type	AR111
Lifespan	40,000h
Ingress Protection Rating	IP20
Dimming	Non- Dimmable
Beam Angle	34°
Body Material	Aluminum+PC Reflector
Mounting Type	Mounted on Ceiling with Frames
Rated CRI	95



Reflector Color Options



Grey

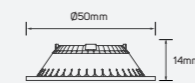

45° ■ PC

Dimensions Options

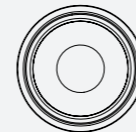
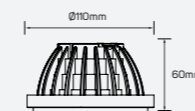

Family Product List

Code No.	Model No.	Power	CCT	Lumen	Efficacy
5101768	ILS20AR111L930WW01	20W	3000K	1600lm	80lm/w
5101769	ILS20AR111L940NW01	20W	4000K	1750lm	87.5lm/w
5101770	ILS20AR111L950DL01	20W	5000K	2050lm	102.5lm/w
5101771	ILS25AR111L930WW01	25W	3000K	1950lm	78lm/w
5101772	ILS25AR111L940NW01	25W	4000K	2150lm	86lm/w
5101773	ILS25AR111L950DL01	25W	5000K	2450lm	98lm/w

Lens Options

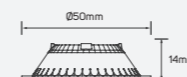

Code No.	Model No.	Beam Angle	Body Color	Material
5101774	ILS45LENSAR111L01	45°	Clear	PC

LED AR111

Refined Brilliance

Areas of Application

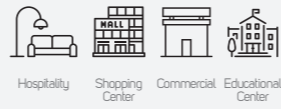

Technical Operating & Electrical Data

Input Voltage & Frequency	AC220-240V, 50/60Hz
Cap Type	AR111
Lifespan	25,000h
Ingress Protection Rating	IP20
Dimming	Dimmable
Beam Angle	30°
Body Material	Aluminum+PC Reflector
Mounting Type	Mounted on Ceiling with Frames
Rated CRI	95

Reflector Color Options



Grey

Dimensions Options

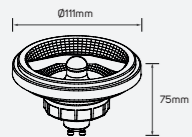

Family Product List

Code No.	Model No.	Power	CCT	Lumen	Efficacy
612451	ILS520AR111L927WW01	10W	2700K	520lm	52lm/w
612452	ILS540AR111L930WW01	10W	3000K	540lm	54lm/w
612453	ILS560AR111L940NW01	10W	4000K	560lm	56lm/w
612454	ILS570AR111L950DL01	10W	5000K	570lm	57lm/w
612455	ILS700AR111L927WW01	14W	2700K	700lm	50lm/w
612456	ILS710AR111L930WW01	14W	3000K	710lm	50lm/w
612457	ILS730AR111L940NW01	14W	4000K	730lm	52lm/w
612458	ILS740AR111L950DL01	14W	5000K	740lm	52lm/w





ArtisticVista

PRODUCT INFORMATION

- Suitable for a series of lighting applications in office, retail and general area lighting.
- Available in a wide variety of lumen packs, cut out size and color temperature.
- ILLUS LED MODULE Luminaire (MR11) gives the customer the flexibility to choose between 12 models based on their specific need with lumen package from 420 lm to 1200 lm.

BENEFITS

- Compact design for better integration with the building.
- Comfortable light with high efficiency.
- Reliable performance for indoor applications.

FEATURES

- High CRI>95.
- Efficacy up to 95lm/w.
- Long life span 30,000hrs.
- Operating voltage AC220-240V .
- Non - dimmable.

LED 50 Module (GU10)

Vision

Technical Operating & Electrical Data

Input Voltage & Frequency	AC220-240V, 50/60Hz
Body Material	Aluminum
Lifespan	30,000h
IP Rating	IP65
Dimming	Non-Dimmable
Beam Angle	24°

Areas of Application

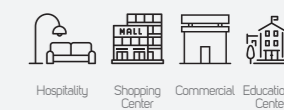

Body Color Options



Grey

Lens Options

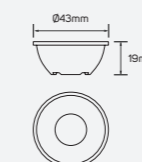

- 15° ■ PC
- 24°
- 36°

Dimensions Options

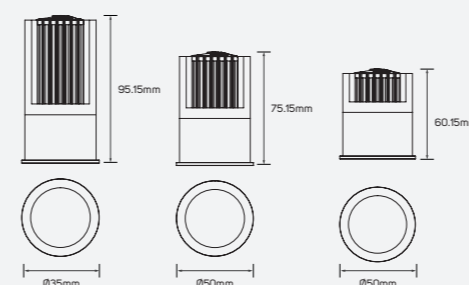

Shape Options



Honeycomb Options

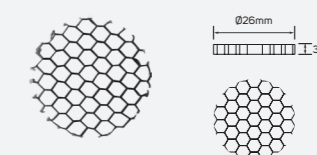

Family Product List

Code No.	Model No.	Power	CCT	Lumen	Efficacy
614083	ILS5.3MR16M927WW01	5.3W	2700K	420lm	79.25lm/W
614084	ILS5.3MR16M930WW01	5.3W	3000K	440lm	83.02lm/W
614085	ILS5.3MR16M940NW01	5.3W	4000K	460lm	86.79lm/W
614086	ILS5.3MR16M950DL01	5.3W	5000K	480lm	90.57lm/W
614088	ILS10MR16M927WW01	10W	2700K	800lm	80lm/W
614089	ILS10MR16M930WW01	10W	3000K	850lm	85lm/W
614090	ILS10MR16M940NW01	10W	4000K	900lm	90lm/W
614091	ILS10MR16M950DL01	10W	5000K	950lm	95lm/W
614093	ILS13MR16M927WW01	13W	2700K	1000lm	76.92lm/W
614094	ILS13MR16M930WW01	13W	3000K	1050lm	80.77lm/W
614095	ILS13MR16M940NW01	13W	4000K	1110lm	85.38lm/W
614096	ILS13MR16M950DL01	13W	5000K	1200lm	92.31lm/W

Driver Specifications

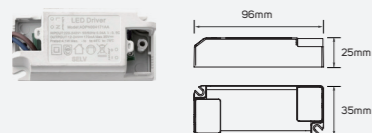

Code No.	Model No.	Power	Body Color	Body Material
614087	ILSACD6WMLD01	6W	white	PVC+copper
614092	ILSACD10WMLD01	10.5W	white	PVC+copper
614097	ILSACD15WMLD01	15W	white	PVC+copper

Lens Specifications

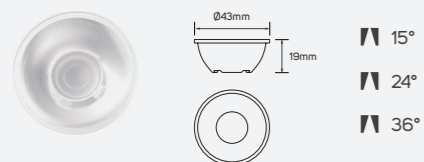

Code No.	Model No.	Beam Angle	Body Color	Body Material
614098	ILS15DGMR16LEN01	15°	transparent	PC
614099	ILS24DGMR16LEN01	24°	transparent	PC
614100	ILS36DGMR16LEN01	36°	transparent	PC

Honeycomb Specifications

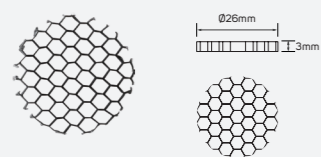

Code No.	Model No.	Body Color	Body Material
614101	ILSMR16HC01	black	PC

LED 50 Module (GU10)

Radiant Light

Technical Operating & Electrical Data

Input Voltage & Frequency	AC220-240V, 50/60Hz
Body Material	Aluminum
Lifespan	25,000h
IP Rating	IP20
Dimming	Non-Dimmable
Beam Angle	36°
Cap Type	GU10

Areas of Application

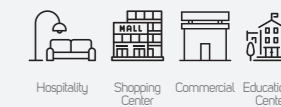

Body Color Options



Black

Lens Options



- 15°
- 24°
- 36°

Dimensions Options

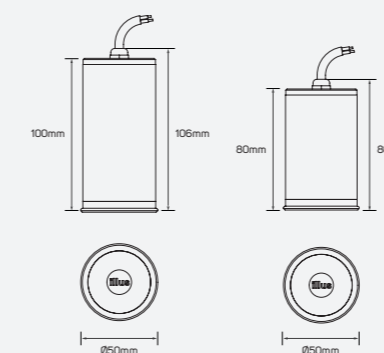

Shape Options



Honeycomb Options

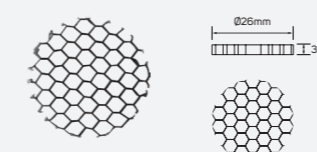

LED 50 Module (GU10)

Sparkle

Areas of Application

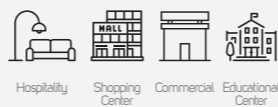

Technical Operating & Electrical Data

Input Voltage & Frequency	AC220-240V, 50/60Hz
Body Material	Aluminum
Lifespan	50,000h
IP Rating	IP20
Dimming	Non-Dimmable
Beam Angle	24°
Rated CRI	95



Shape&Body Color Options



Lens Options

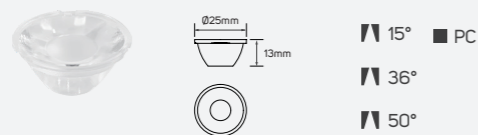

Dimensions Options

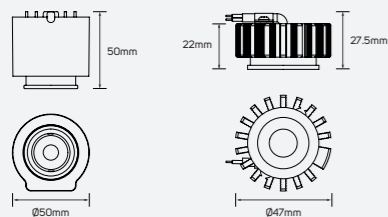

Family Product List

Code No.	Model No.	Body Color	Power	Lumen	Efficacy	CCT
5101782	ILS11MR11M927WW01	Grey	11W	760lm	69.09lm/w	2700K
5101783	ILS11MR11M930WW01	Grey	11W	780lm	70.91lm/w	3000K
5101784	ILS11MR11M940NW01	Grey	11W	820lm	74.55lm/w	4000K
5101785	ILS11MR11M950DL01	Grey	11W	880lm	80lm/w	5000K
5101786	ILS6MR11M927WW01	Black	6W	440lm	73.33lm/w	2700K
5101787	ILS6MR11M930WW01	Black	6W	450lm	75lm/w	3000K
5101788	ILS6MR11M940NW01	Black	6W	480lm	80lm/w	4000K
5101789	ILS6MR11M950DL01	Black	6W	520lm	86.67lm/w	5000K

Lens Specifications

Code No.	Model No.	Beam Angle	Body Color	Body Material
5101790	ILS15LENSMR11M01	15°	Clear	PC
5101791	ILS36LENSMR11M01	36°	Clear	PC
5101792	ILS45LENSMR11M01	50°	Clear	PC

LED 50 Module (GU10)

Agile

Areas of Application

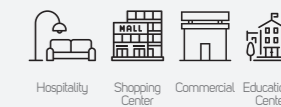

Technical Operating & Electrical Data

Input Voltage & Frequency	AC220-240V, 50/60Hz
Body Material	Aluminum
Lifespan	50,000h
IP Rating	IP20
Dimming	Non-Dimmable
Beam Angle	24°
Rated CRI	95



Shape&Body Options



Lens Options

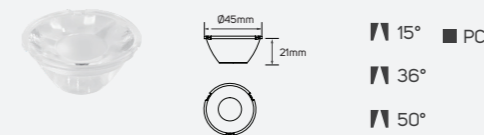

Dimensions Options

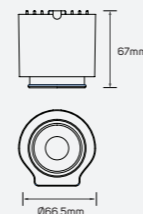

Family Product List

Code No.	Model No.	Lumen	Efficacy	CCT	Lamp Type
5101775	ILS19GU10M927WW01	1450lm	76.32lm/w	2700K	Direct
5101776	ILS19GU10M930WW01	1500lm	78.95lm/w	3000K	Direct
5101777	ILS19GU10M940NW01	1700lm	89.47lm/w	4000K	Direct
5101778	ILS19GU10M950DL01	1800lm	94.74lm/w	5000K	Direct

Lens Specifications

Code No.	Model No.	Beam Angle	Body Color	Body Material
5101779	ILS15LENSGU10M01	15°	Clear	PC
5101780	ILS36LENSGU10M01	36°	Clear	PC
5101781	ILS45LENSGU10M01	50°	Clear	PC



Wisdom

PRODUCT INFORMATION

- Suitable for a series of lighting applications in office, retail and general area lighting.
- Available in a wide variety of lumen packs, cut out size and color temperature.
- ILLUS LED MODULE Luminaire (MR11) gives the customer the flexibility to choose between 12 models based on their specific need with lumen package from 300 lm to 580 lm.

BENEFITS

- Compact design for better integration with the building.
- Comfortable light with high efficiency.
- Reliable performance for indoor applications.

FEATURES

- High CRI>95.
- Efficacy up to 79lm/w.
- Long life span 30,000hrs.
- Operating voltage AC220-240V .
- Non – dimmable.

LED 35 Module (MR11)

Wisdom

Technical Operating & Electrical Data

Input Voltage & Frequency	AC220-240V, 50/60Hz
Body Material	Aluminum
Lifespan	30,000h
Ingress Protection Rating	IP65
Dimming	Non-Dimmable
Beam Angle	30°

Areas of Application

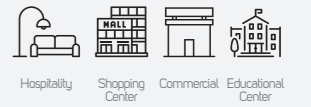

Body Color Options



Grey

Lens Options

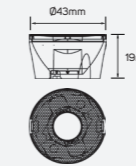

- 15° ■ PC
- 24°

Dimensions Options

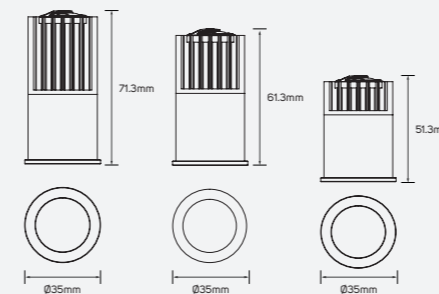

Shape Options



Honeycomb Options

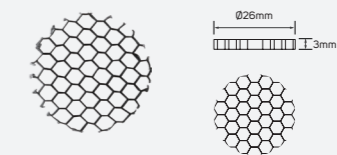

Family Product List

Code No.	Model No.	Power	CCT	Lumen	Efficacy
614102	ILS4.2MR11M927WW01	4.2W	2700K	300lm	71.43lm/W
614103	ILS4.2MR11M930WW01	4.2W	3000K	305lm	72.62lm/W
614104	ILS4.2MR11M940NW01	4.2W	4000K	315lm	75lm/W
614105	ILS4.2MR11M950DL01	4.2W	5000K	325lm	77.38lm/W
614107	ILS5.3MR11M927WW01	5.3W	2700K	380lm	71.7lm/W
614108	ILS5.3MR11M930WW01	5.3W	3000K	400lm	75.47lm/W
614109	ILS5.3MR11M940NW01	5.3W	4000K	420lm	79.25lm/W
614110	ILS5.3MR11M950DL01	5.3W	5000K	445lm	59.33lm/W
614111	ILS7.5MR11M927WW01	7.5W	2700K	490lm	65.33lm/W
614112	ILS7.5MR11M930WW01	7.5W	3000K	520lm	69.33lm/W
614113	ILS7.5MR11M940NW01	7.5W	4000K	550lm	73.33lm/W
614114	ILS7.5MR11M950DL01	7.5W	5000K	580lm	77.33lm/W

Driver Specifications

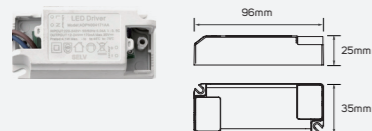

Code No.	Model No.	Power	Body Color	Body Material
● 614106	ILSACD4WMLD01	5.3W	white	PVC+copper
● 614118	ILSACD8WMLD01	6W	white	PVC+copper

Lens Specifications

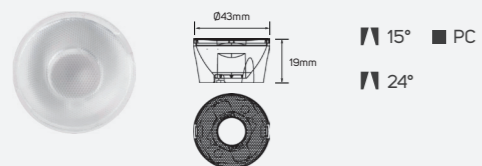

Code No.	Model No.	Beam Angle	Body Color	Body Material
● 614115	ILS12DGMR11LEN01	12°	white	PC
● 614116	ILS24DGMR11LEN01	24°	white	PC

Honeycomb Specifications

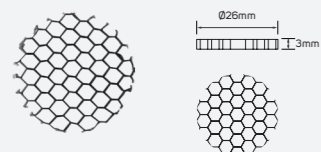

Code No.	Model No.	Body Color	Body Material
● 614117	ILSMR11HC01	black	PC





LED G9 Lamp

Vivid

Technical Operating & Electrical Data

Input Voltage & Frequency	AC220-240V, 50/60Hz
Rated CRI	95
Lifespan	30,000h
Cap Type	G9
Ingress Protection Rating	IP20
Dimming	Non-Dimmable
Ambient Temperature	-25~+45° C
Switching Cycle	100000x on/off
IEC Classification	Class II

Dimensions Options

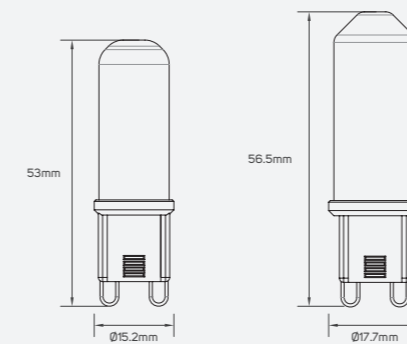

Family Product List

Code No.	Model No.	Power	Lumen	CCT	Efficacy	Beam Angle	Current
615319	ILS2.3WG9L927WW02	2.3W	240lm	2700K	104.35lm/W	320°	21mA
615320	ILS2.3WG9L930WW02	2.3W	260lm	3000K	113.04lm/W	320°	21mA
615321	ILS2.3WG9L940NW02	2.3W	285lm	4000K	123.91lm/W	320°	21mA
615322	ILS3.2WG9L927WW02	3.2W	370lm	2700K	115.63lm/W	320°	24mA
615323	ILS3.2WG9L930WW02	3.2W	395lm	3000K	123.44lm/W	320°	24mA
615324	ILS3.2WG9L940NW02	3.2W	430lm	4000K	134.38lm/W	320°	24mA

Areas of Application

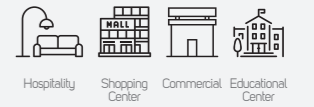

LED G9 Lamp

PRODUCT INFORMATION

- LED spots G9 are designed as a retrofit replacement for halogen spots.
- Deliver significant energy savings and minimize initial investment.
- ILLUS LED G9 lamp gives the customer the flexibility to choose between 6 models based on their specific need with lumen package from 240lm to 430lm.

BENEFITS

- Up to 90% energy saving compared with traditional halogen lamps.
- Lower maintenance costs.
- Low initial investment.

FEATURES

- High CRI>95.
- Efficacy up to 134lm/w.
- Long lifespan 30000H.
- Wide operating voltage AC220-240V.
- Non-Dimmable.
- UV-and IR-free light.



LED GU10 Lamp

PRODUCT INFORMATION

- LED spots GU10 are designed as a retrofit replacement for halogen spots.
- Deliver significant energy savings and minimize initial investment.
- ILLUS LED GU10 lamp gives the customer the flexibility to choose between 4 models based on their specific need with lumen package from 500lm to 540lm.

BENEFITS

- Up to 90% energy saving compared with traditional halogen lamps.
- Lower maintenance costs.
- Low initial investment.

FEATURES

- High CRI>97.
- Efficacy up to 120lm/w.
- Long lifespan 30000H.
- Wide operating voltage AC220-240V.
- UV-and-IR-free light.
- Non-Dimmable.

LED GU10 Lamp

Ocean

Technical Operating & Electrical Data

Input Voltage & Frequency	AC220-240V, 50/60Hz
Rated CRI	97
Lifespan	30,000h
Cap Type	GU10
Ingress Protection Rating	IP20
Dimming	Non-Dimmable
Ambient Temperature	-25--+45° C
Switching Cycle	100000x on/off
IEC Classification	Class II

Dimensions Options

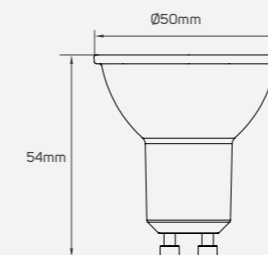

Areas of Application

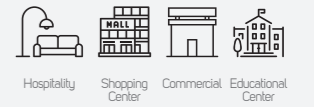

Family Product List

Code No.	Model No.	Power	Lumen	CCT	Efficacy	Beam Angle	Current
615325	ILS36D4.5GU10L927WW02	4.5W	500lm	2700K	111.11lm/W	36°	38mA
615326	ILS36D4.5GU10L930WW02	4.5W	510lm	3000K	113.33lm/W	36°	38mA
615327	ILS36D4.5GU10L940NW02	4.5W	530lm	4000K	117.78lm/W	36°	38mA
615328	ILS36D4.5GU10L950DL02	4.5W	540lm	5000K	120lm/W	36°	38mA



LED GU10 Lamp

Vega

Technical Operating & Electrical Data

Input Voltage & Frequency	AC220-240V, 50/60Hz
Rated CRI	97
Lifespan	30,000h
Cap Type	GU10
Ingress Protection Rating	IP20
Dimming	Dimmable
Ambient Temperature	-25~+45° C
Switching Cycle	100000x on/off
IEC Classification	Class II

Areas of Application

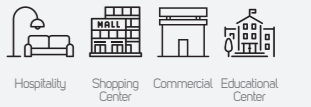

Dimensions Options

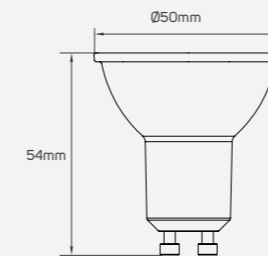

Family Product List

Code No.	Model No.	Power	Lumen	CCT	Efficacy	Beam Angle	Current
615329	ILS36D5.9DGU10L927WW02	5.9W	620lm	2700K	105.08lm/W	36°	30mA
615330	ILS36D5.9DGU10L930WW02	5.9W	630lm	3000K	106.78lm/W	36°	30mA
615331	ILS36D5.9DGU10L935WW02	5.9W	635lm	3500K	107.63lm/W	36°	30mA
615332	ILS36D5.9DGU10L940NW02	5.9W	640lm	4000K	108.47lm/W	36°	30mA
615333	ILS36D5.9DGU10L950DL02	5.9W	650lm	5000K	110.17lm/W	36°	30mA
615334	ILS24D5.9DGU10L927WW02	5.9W	630lm	2700K	106.78lm/W	24°	30mA
615335	ILS24D5.9DGU10L930WW02	5.9W	640lm	3000K	108.47lm/W	24°	30mA
615336	ILS24D5.9DGU10L935WW02	5.9W	645lm	3500K	109.32lm/W	24°	30mA
615337	ILS24D5.9DGU10L940NW02	5.9W	650lm	4000K	110.17lm/W	24°	30mA
615338	ILS24D5.9DGU10L950DL02	5.9W	660lm	5000K	111.86lm/W	24°	30mA
615339	ILS60D5.9DGU10L927WW02	5.9W	610lm	2700K	103.39lm/W	60°	30mA
615340	ILS60D5.9DGU10L930WW02	5.9W	615lm	3000K	104.24lm/W	60°	30mA
615342	ILS60D5.9DGU10L940NW02	5.9W	625lm	4000K	105.93lm/W	60°	30mA
615343	ILS60D5.9DGU10L950DL02	5.9W	630lm	5000K	106.78lm/W	60°	30mA
615344	ILS110D5.9DGU10L927WW02	5.9W	625lm	2700K	105.93lm/W	110°	30mA
615345	ILS110D5.9DGU10L930WW02	5.9W	630lm	3000K	106.78lm/W	110°	30mA
615347	ILS110D5.9DGU10L940NW02	5.9W	635lm	4000K	107.63lm/W	110°	30mA
615348	ILS110D5.9DGU10L950DL02	5.9W	640lm	5000K	108.47lm/W	110°	30mA

LED GU10 Lamp

PRODUCT INFORMATION

- LED spots GU10 are designed as a retrofit replacement for halogen spots.
- Deliver significant energy savings and minimize initial investment.
- ILLUS LED GU10 lamp gives the customer the flexibility to choose between 18 models based on their specific need with lumen package from 610lm to 660lm.

BENEFITS

- Up to 90% energy saving compared with traditional halogen lamps.
- Lower maintenance costs.
- Low initial investment.

FEATURES

- High CRI>97.
- Efficacy up to 112lm/w.
- Long lifespan 30000H.
- Wide operating voltage AC220-240V.
- UV-and-IR-free light.
- Dimmable.



LED GU10 Lamp

Unique

Technical Operating & Electrical Data

Input Voltage & Frequency	AC220-240V, 50/60Hz
Cap Type	GU10
Body Material	Aluminum+PC
Body Color	Black
Power	7W
Lamp Type	Direct
Displacement Factor	0.89
Power Factor	0.86
IEC Classification	Class II
Dimming	Dimmable
Ambient Temperature	-20~50° C
Lifespan	55,000h
Switching Cycle	100000x on/off
Warranty Period	72 Months

Areas of Application

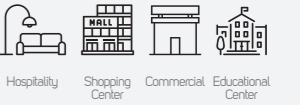

Dimensions Options

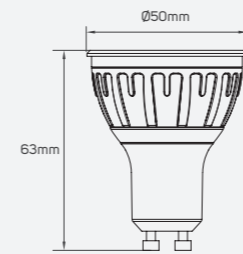

ACCESSORIES Options

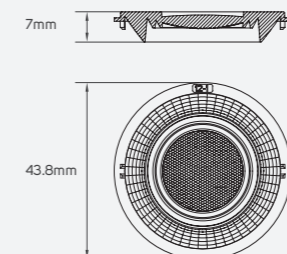

○ 615600 PC 24°



○ 615601 PC 60°



○ 615601 PC 120°

LED GU10 Lamp

PRODUCT INFORMATION

- LED spots GU10 are designed as a retrofit replacement for halogen spots.
- Deliver significant energy savings and minimize initial investment.
- ILLUS LED GU10 lamp gives the customer the flexibility to choose between 10 models based on their specific need with lumen package from 410lm to 770lm.

BENEFITS

- Up to 90% energy saving compared with traditional halogen lamps.
- Lower maintenance costs.
- Low initial investment.

FEATURES

- High CRI>97
- Efficacy up to 110lm/w.
- Long lifespan 55000H.
- Wide operating voltage AC220-240V.
- Dimmable.

Family Product List

Code No.	Model No.	Power	Lumen	Useful Lumen	Efficacy	CCT	CRI	Beam Angle	Current	Saving Energy
● 615590	ILS7D10AGU10L927WW01	7W	460lm	410lm	58.57lm/W	2700K	97	10°	30mA	89%
● 615591	ILS7D10AGU10L930WW01	7W	470lm	420lm	60lm/W	3000K	97	10°	30mA	90%
● 615592	ILS7D10AGU10L935WW01	7W	480lm	430lm	61.43lm/W	3500K	97	10°	30mA	90%
● 615593	ILS7D10AGU10L940NW01	7W	500lm	450lm	64.29lm/W	4000K	97	10°	30mA	91%
● 615594	ILS7D10AGU10L950DL01	7W	530lm	480lm	68.57lm/W	5000K	97	10°	30mA	91%
● 615595	ILS7D36AGU10L927WW01	7W	810lm	710lm	101.43lm/W	2700K	98	36°	30mA	93%
● 615596	ILS7D36AGU10L930WW01	7W	830lm	730lm	104.29lm/W	3000K	98	36°	30mA	93%
● 615597	ILS7D36AGU10L935WW01	7W	835lm	735lm	105lm/W	3500K	98	36°	30mA	93%
● 615598	ILS7D36AGU10L940NW01	7W	850lm	750lm	107.14lm/W	4000K	98	36°	30mA	93%
● 615599	ILS7D36AGU10L950DL01	7W	870lm	770lm	110lm/W	5000K	98	36°	30mA	93%



GU10 Lamp

EclipseGlow

Technical Operating & Electrical Data

Input Voltage & Frequency	AC220-240V, 50/60Hz
Rated CRI	95
Lifespan	40,000h
Displacement Factor	0.9
Ingress Protection Rating	IP20
Dimming	Dimmable
Ambient Temperature	-20~45° C
Switching Cycle	100000x on/off
IEC Classification	Class II

Areas of Application

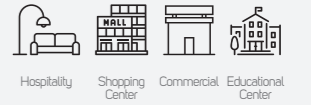

Dimensions Options

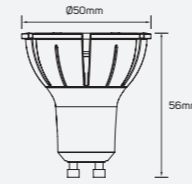

Vivid

PRODUCT INFORMATION

- LED spots GU10 are a perfect fit for spot lighting and deliver warm halogen light.
- Deliver significant energy savings and minimize maintenance cost.
- ILLUS LED GU10 lamp gives the customer the flexibility to choose between 4 CCT & 4 different beam angles based on their specific need with lumen package from 360 lm to 560 lm.

BENEFITS

- Variety of beam angles.
- Up to 80% energy saving compared with halogen lamps.
- Lower maintenance costs.
- Longer Life Time.

FEATURES

- High CRI>95.
- Efficacy up to 80 lm/w.
- Long life span 40,000h
- Operating voltage AC220 – 240V.
- Dimmable.
- UV – IR – free light.

Family Product List

Code No.	Model No.	Power	Beam Angle	CCT	Lumen	Efficacy	Current
● 612546	ILS7D10GU10L927WW01	7W	10°	2700k	360lm	51lm/W	38mA
● 612547	ILS7D10GU10L930WW01	7W	10°	3000k	380lm	54lm/W	38mA
● 612548	ILS7D10GU10L940NW01	7W	10°	4000k	400lm	57lm/W	38mA
● 612549	ILS7D10GU10L950DL01	7W	10°	5000k	410lm	59lm/W	38mA
● 612550	ILS7D24GU10L927WW01	7W	24°	2700K	470lm	67lm/W	38mA
● 612551	ILS7D24GU10L930WW01	7W	24°	3000K	500lm	71lm/W	38mA
● 612552	ILS7D24GU10L940NW01	7W	24°	4000K	540lm	77lm/W	38mA
● 612553	ILS7D24GU10L950DL01	7W	24°	5000K	560lm	80lm/W	38mA
● 612554	ILS7D36GU10L927WW01	7W	36°	2700K	460lm	66lm/W	38mA
● 612555	ILS7D36GU10L930WW01	7W	36°	3000K	490lm	70lm/W	38mA
● 612556	ILS7D36GU10L940NW01	7W	36°	4000K	530lm	76lm/W	38mA
● 612557	ILS7D36GU10L950DL01	7W	36°	5000K	550lm	79lm/W	38mA
● 612558	ILS7D60GU10L927WW01	7W	60°	2700K	440lm	63lm/W	38mA
● 612559	ILS7D60GU10L930WW01	7W	60°	3000K	460lm	66lm/W	38mA
● 612560	ILS7D60GU10L940NW01	7W	60°	4000K	500lm	71lm/W	38mA
● 612561	ILS7D60GU10L950DL01	7W	60°	5000K	530lm	76lm/W	38mA



GU10 Lamp

LuminanceLink

Areas of Application

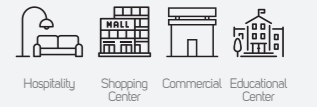

Technical Operating & Electrical Data

Rated CRI	95
Lifespan	25,000h
Displacement Factor	0.5
Ingress Protection Rating	IP20
Ambient Temperature	-20~40° C
Switching Cycle	100000x on/off
IEC Classification	Class II



Dimensions Options

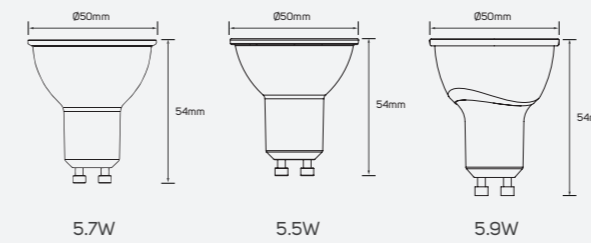

Family Product List

Code No.	Model No.	Power	Beam Angle	CCT	Lumen	Efficacy	Input Voltage	Dimming
612447	ILS460GU10L927WW01	5.7W	36°	2700k	460lm	81lm/W	AC100-240V	Non-Dimmable
612448	ILS470GU10L930WW01	5.7W	36°	3000k	470lm	82lm/W	AC100-240V	Non-Dimmable
612449	ILS480GU10L940NW01	5.7W	36°	4000k	480lm	84lm/W	AC100-240V	Non-Dimmable
612450	ILS490GU10L950DL01	5.7W	36°	5000k	490lm	86lm/W	AC100-240V	Non-Dimmable
612599	ILS440DGU10L927WW01	5.5W	36°	2700k	440lm	80lm/w	AC220-240V	Dimmable
612600	ILS450DGU10L930WW01	5.5W	36°	3000k	450lm	81.82lm/w	AC220-240V	Dimmable
612601	ILS470DGU10L940NW01	5.5W	36°	4000k	470lm	85.45lm/w	AC220-240V	Dimmable
612602	ILS480DGU10L950DL01	5.5W	36°	5000k	480lm	87.27lm/w	AC220-240V	Dimmable

Vivid

PRODUCT INFORMATION

- LEDspots GU10 are designed as a retrofit replacement for halogen spots.
- Deliver significant energy savings and minimize initial investment.
- ILLUS LED GU10 lamp gives the customer the flexibility to choose between 4 CCT based on their specific need with lumen package from 440 lm to 490 lm.

BENEFITS

- Up to 90% energy saving compared with traditional halogen lamps.
- Lower maintenance costs.
- Low initial investment.

FEATURES

- High CRI>95.
- Efficacy up to 87 lm/w.
- Long life span 25,000h
- Non - dimmable.
- UV - IR - free light.



GU10 Lamp

PureRadiance

Areas of Application

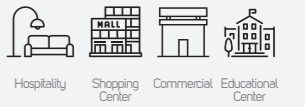

Technical Operating & Electrical Data

Rated CRI	95
Lifespan	25,000h
Displacement Factor	0.5
Ingress Protection Rating	IP20
Ambient Temperature	-20°~+45° C
Switching Cycle	100000x on/off
IEC Classification	Class II



Dimensions Options

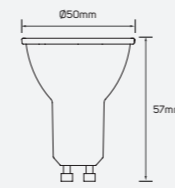

5.7W/7.7W

Family Product List

Code No.	Model No.	Power	Input Voltage	Beam Angle	CCT	Lumen	Efficacy	Dimming
612631	ILS36D7.7DGU10L927WW01	7.7W	AC220-240V	36°	2700K	600lm	77.92lm/W	Dimmable
612632	ILS36D7.7DGU10L930WW01	7.7W	AC220-240V	36°	3000K	610lm	79.22lm/W	Dimmable
612633	ILS36D7.7DGU10L940NW01	7.7W	AC220-240V	36°	4000K	640lm	83.12lm/W	Dimmable
612634	ILS36D7.7DGU10L950DL01	7.7W	AC220-240V	36°	5000K	650lm	84.42lm/W	Dimmable
612635	ILS60D7.7DGU10L927WW01	7.7W	AC220-240V	60°	2700K	500lm	64.94lm/W	Dimmable
612636	ILS60D7.7DGU10L930WW01	7.7W	AC220-240V	60°	3000K	510lm	66.23lm/W	Dimmable
612637	ILS60D7.7DGU10L940NW01	7.7W	AC220-240V	60°	4000K	530lm	68.83lm/W	Dimmable
612638	ILS60D7.7DGU10L950DL01	7.7W	AC220-240V	60°	5000K	540lm	70.13lm/W	Dimmable
612639	ILS100D7.7DGU10L927WW01	7.7W	AC220-240V	100°	2700K	560lm	72.73lm/W	Dimmable
612640	ILS100D7.7DGU10L930WW01	7.7W	AC220-240V	100°	3000K	570lm	74.03lm/W	Dimmable
612641	ILS100D7.7DGU10L940NW01	7.7W	AC220-240V	100°	4000K	590lm	76.62lm/W	Dimmable
612642	ILS100D7.7DGU10L950DL01	7.7W	AC220-240V	100°	5000K	600lm	77.92lm/W	Dimmable
612643	ILS60D5.7GU10L927WW01	5.7W	AC100-240V	60°	2700K	400lm	70.18lm/W	Non-Dimmable
612644	ILS60D5.7GU10L930WW01	5.7W	AC100-240V	60°	3000K	410lm	71.93lm/W	Non-Dimmable
612645	ILS60D5.7GU10L940NW01	5.7W	AC100-240V	60°	4000K	430lm	75.44lm/W	Non-Dimmable
612646	ILS60D5.7GU10L950DL01	5.7W	AC100-240V	60°	5000K	440lm	77.19lm/W	Non-Dimmable
612647	ILS110D5.7GU10L927WW01	5.7W	AC100-240V	110°	2700K	410lm	71.93lm/W	Non-Dimmable
612648	ILS110D5.7GU10L930WW01	5.7W	AC100-240V	110°	3000K	420lm	73.68lm/W	Non-Dimmable
612649	ILS110D5.7GU10L940NW01	5.7W	AC100-240V	110°	4000K	440lm	77.19lm/W	Non-Dimmable
612650	ILS110D5.7GU10L950DL01	5.7W	AC100-240V	110°	5000K	450lm	78.95lm/W	Non-Dimmable

Vivid

PRODUCT INFORMATION

- LEDspots GU10 are designed as a retrofit replacement for halogen spots.
- Deliver significant energy savings and minimize initial investment.
- ILLUS LED GU10 lamp gives the customer the flexibility to choose between 20 models based on their specific need with lumen package from 400 lm to 650 lm.

BENEFITS

- Up to 90% energy saving compared with traditional halogen lamps.
- Lower maintenance costs.
- Low initial investment.

FEATURES

- High CRI>95.
- Efficacy up to 84lm/w.
- Long life span 25,000 hrs.
- UV – and IR – free light.



GU10 Lamp

VividGlow

Technical Operating & Electrical Data

Input Voltage & Frequency	AC220-240V, 50/60Hz
Rated CRI	90
Lifespan	25,000h
Displacement Factor	0.95
Ingress Protection Rating	IP20
Beam Angle	40°
Dimming	Non-Dimmable
Ambient Temperature	-20°~+45° C
Switching Cycle	100000x on/off
IEC Classification	Class II

Areas of Application

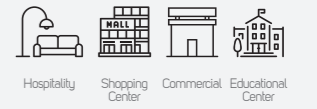

Ambient Temperature



Dimensions Options

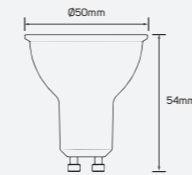

Family Product List

Code No.	Model No.	Power	Material	CCT	Total Lumen	Useful Lumen	Efficacy	Current
612459	ILS370GU10L927WW01	4.8W	Glass	2700k	450lm	370lm	94lm/W	38mA
612460	ILS380GU10L930WW01	4.8W	Glass	3000k	470lm	380lm	98lm/W	39mA
612461	ILS410GU10L940NW01	4.8W	Glass	4000k	500lm	410lm	104lm/W	37mA
612462	ILS420GU10L950DL01	4.8W	Glass	5000k	510lm	420lm	106lm/W	37mA

Vivid

PRODUCT INFORMATION

- LEDspots GU10 are designed as a retrofit replacement for halogen spots.
- Deliver significant energy savings and minimize initial investment.
- ILLUS LED GU10 lamp gives the customer the flexibility to choose between 4 CCT based on their specific need with lumen package from 450 lm to 510 lm.

BENEFITS

- Up to 90% energy saving compared with traditional halogen lamps.
- Lower maintenance costs.
- Low initial investment.

FEATURES

- High CRI>90.
- Efficacy up to 106 lm/w.
- Long life span 25,000h
- Operating voltage AC220 - 240V.
- Non - dimmable.
- UV - IR - free light.





LED Smart Lamp

Velvet Visions

Areas of Application



Technical Operating & Electrical Data

Input Voltage & Frequency	AC220-240V, 50/60Hz
Lifespan	15,000h
Ingress Protection Rating	IP20
Dimming	Dimmable



Body Color Options



White

Shape Options



Dimensions Options

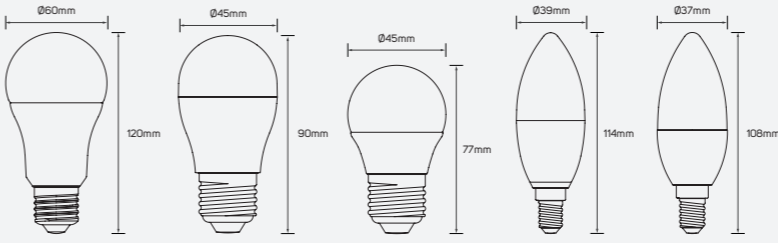

Miracle

PRODUCT INFORMATION

- Easy plug and play, works with your existing Wi-Fi.
- Voice control with google assistant, Alexa or Siri shortcuts.
- ILLUS LED SMART FILAMENT Lamp gives the customer the flexibility to choose between 6 models based on their specific need with lumen package from 380 lm to 950 lm.

BENEFITS

- Automate your light with schedules.
- Energy monitoring.
- Tunable warm to cool white modes.

FEATURES

- High CRI>90.
- Efficacy up to 96 lm/w.
- Long life span 15,000 hrs.
- Operating voltage AC220 – 240V.
- Dimmable.

Family Product List

Code No.	Model No.	Power	Beam Angle	CCT	Lumen	Efficacy
612963	ILS10A60E27L91865WB01	10W	220°	1800K-6500K	950lm@6500K	95lm/W
612964	ILS10A60E27L92765RGBWB01	10W	220°	2700K-6500K+RGB	806lm@2700K	80.60lm/W
612967	ILS4.9C37E14L91865WB01	4.9W	220°	1800K-6500K	450lm@6500K	91.84lm/W
612968	ILS4.9C37E14L92765RGBWB01	4.9W	220°	2700K-6500K+RGB	380lm@2700K	77.55lm/W
612969	ILS4.9C45E27L91865WB01	4.9W	160°	1800K-6500K	470lm@6500K	95.92lm/W
612970	ILS4.9C45E27L92765RGBWB01	4.9W	160°	2700K-6500K+RGB	400lm@2700K	81.63lm/W

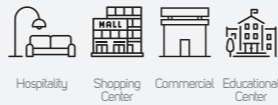

Gentle

Technical Operating & Electrical Data

Input Voltage & Frequency	AC220-240V, 50/60Hz
Lifespan	15,000h
Ingress Protection Rating	IP20
Dimming	Dimmable



Body Color Options

Shape Options



White



Dimensions Options

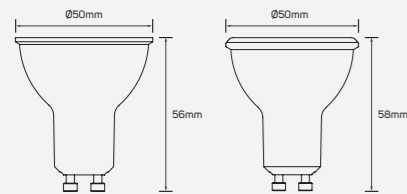

Family Product List

Code No.	Model No.	Power	Beam Angle	CCT	Lumen	Efficacy
612965	ILS4.9C21GU10L91865WB01	4.9W	36°	1800K-6500K	300lm@6500K	61.22lm/W
612966	ILS4.9C21GU10L92765RGBWB01	4.9W	36°	2700K-6500K+RGB	280lm@2700K	57.14lm/W

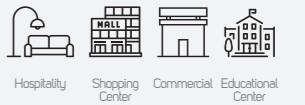

StarlightSymphony

Technical Operating & Electrical Data

Input Voltage & Frequency	AC220-240V, 50/60Hz
Lifespan	15,000h
Ingress Protection Rating	IP20
Dimming	Dimmable
Beam Angle	330°



Body Color Options

Shape Options



Clear golden



Dimensions Options

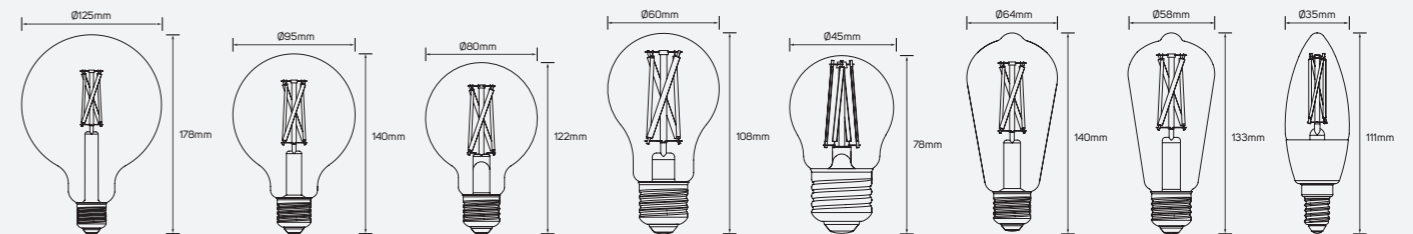

Family Product List

Code No.	Model No.	Power	CCT	Lumen	Efficacy
612971	ILS7A60E27L91865WB01	7W	1800K-6500K	806lm@6500K	115.14lm/W
612972	ILS7A60E27L91750WB01	7W	1700K-5000K	720lm@5000K	102.86lm/W
612973	ILS4.9C35E14L91865WB01	4.9W	1800K-6500K	470lm@6500K	95.92lm/W
612974	ILS4.9C35E14L91750WB01	4.9W	1700K-5000K	420lm@5000K	85.71lm/W
612975	ILS4.9C45E27L91865WB02	4.9W	1800K-6500K	470lm@6500K	95.92lm/W
612976	ILS4.9C45E27L91750WB01	4.9W	1700K-5000K	420lm@5000K	85.71lm/W
612977	ILS7G80E27L91865WB01	7W	1800K-6500K	806lm@6500K	115.14lm/W
612978	ILS7G80E27L91750WB01	7W	1700K-5000K	720lm@5000K	102.86lm/W
612979	ILS7G95E27L91865WB01	7W	1800K-6500K	806lm@6500K	115.14lm/W
612980	ILS7G95E27L91750WB01	7W	1700K-5000K	720lm@5000K	102.86lm/W
612981	ILS7G125E27L91865WB01	7W	1800K-6500K	806lm@6500K	115.14lm/W
612982	ILS7G125E27L91750WB01	7W	1700K-5000K	750lm@5000K	107.14lm/W

Family Product List

Code No.	Model No.	Power	CCT	Lumen	Efficacy
○ 612983	ILS7ST58E27L91865WB01	7W	1800K-6500K	806lm@6500K	115.14lm/W
● 612984	ILS4.9ST58E27L91750WB01	4.9W	1700K-5000K	420lm@5000K	85.71lm/W
○ 612985	ILS7ST64E27L91865WB01	7W	1800K-6500K	806lm@6500K	115.14lm/W
● 612986	ILS7ST64E27L91750WB01	7W	1700K-5000K	720lm@5000K	102.86lm/W





LED Non-Directional Lamp

Celestial Sway

Areas of Application

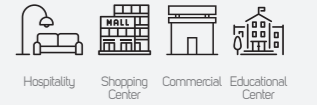

Technical Operating & Electrical Data

Input Voltage & Frequency	AC220-240V, 50/60Hz
Rated CRI	92
Lifespan	15,000h
Ingress Protection Rating	IP20
Dimming	Non-Dimming
Directional or Non Directional	Non-Directional
Fixed or Adjustable	Fixed



Body Color Options



WH

Shape Options



Dimensions Options

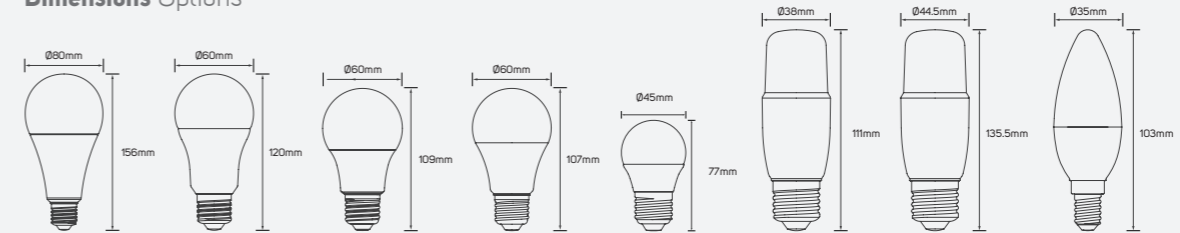

Family Product List

Code No.	Model No.	Power	Beam Angle	CCT	Lumen	Efficacy
612794	ILS7.5A60E27L930WW01	7.5W	150°	3000K	820lm	109.33lm/W
612795	ILS7.5A60E27L940NW01	7.5W	150°	4000K	830lm	110.67lm/W
612796	ILS7.5A60E27L950DL01	7.5W	150°	5000K	840lm	112lm/W
612797	ILS9A60E27L930WW01	9W	150°	3000K	1030lm	114.44lm/W
612798	ILS9A60E27L940NW01	9W	150°	4000K	1050lm	116.67lm/W
612799	ILS9A60E27L950DL01	9W	150°	5000K	1060lm	117.78lm/W
612800	ILS11.5A60E27L930WW01	11.5W	150°	3000K	1520lm	132.17lm/W
612801	ILS11.5A60E27L940NW01	11.5W	150°	4000K	1550lm	134.78lm/W
612802	ILS11.5A60E27L950DL01	11.5W	150°	5000K	1600lm	139.13lm/W
612803	ILS17A80E27L930WW01	17W	150°	3000K	2300lm	135.29lm/W
612804	ILS17A80E27L940NW01	17W	150°	4000K	2350lm	138.24lm/W

ColorStream

PRODUCT INFORMATION

- Combines the familiar shapes of classic incandescent bulbs with long lasting LED technology.
- Delivers beautiful warm white light while saving energy costs compared with traditional light bulbs.
- ILLUS LED NON – DIRECTIONAL Lamp gives the customer the flexibility to choose between 11 models based on their specific need with lumen package from 820 lm to 2350 lm.

BENEFITS

- Very long lifetime that reduces the need for replacement.
- Easy replacement of classic conventional lamps.

FEATURES

- High CRI>92.
- Efficacy up to 139 lm/w.
- Long life span 15,000 hrs.
- Operating voltage AC100 – 240V.
- Non – dimmable.

Family Product List

Code No.	Model No.	Power	Beam Angle	CCT	Lumen	Efficacy
612806	ILS4.5C35E14L930WW01	4.5W	250°	3000K	450lm	100lm/W
612807	ILS4.5C35E14L940NW01	4.5W	250°	4000K	460lm	102.22lm/W
612808	ILS4.5C35E14L950DL01	4.5W	250°	5000K	470lm	104.44lm/W
612809	ILS6.2C35E14L930WW01	6.2W	250°	3000K	820lm	132.26lm/W
612810	ILS6.2C35E14L940NW01	6.2W	250°	4000K	830lm	133.87lm/W
612811	ILS6.2C35E14L950DL01	6.2W	250°	5000K	840lm	135.48lm/W
612812	ILS4.5G45E27L930WW01	4.5W	150°	3000K	460lm	102.22lm/W
612813	ILS4.5G45E27L940NW01	4.5W	150°	4000K	470lm	104.44lm/W
612814	ILS4.5G45E27L950DL01	4.5W	150°	5000K	480lm	106.67lm/W
612815	ILS6.2G45E27L930WW01	6.2W	150°	3000K	820lm	132.26lm/W
612816	ILS6.2G45E27L940NW01	6.2W	150°	4000K	830lm	133.87lm/W
612817	ILS6.2G45E27L950DL01	6.2W	150°	5000K	840lm	135.48lm/W
612818	ILS7.5T37E27L930WW01	7.5W	200°	3000K	800lm	106.67lm/W
612819	ILS7.5T37E27L940NW01	7.5W	200°	4000K	805lm	107.33lm/W
612820	ILS7.5T37E27L950DL01	7.5W	200°	5000K	810lm	108lm/W
612821	ILS9T37E27L930WW01	9W	200°	3000K	1020lm	113.33lm/W
612822	ILS9T37E27L940NW01	9W	200°	4000K	1030lm	114.44lm/W
612823	ILS9T37E27L950DL01	9W	200°	5000K	1050lm	116.67lm/W
612824	ILS11T45E27L930WW01	11W	200°	3000K	1510lm	137.27lm/W
612825	ILS11T45E27L940NW01	11W	200°	4000K	1520lm	138.18lm/W
612826	ILS11T45E27L950DL01	11W	200°	5000K	1530lm	139.09lm/W





ColorStream

PRODUCT INFORMATION

- LEDspots G9 are designed as a retrofit replacement for halogen spots.
- Deliver significant energy savings and minimize initial investment.
- ILLUS LED G9 lamp gives the customer the flexibility to choose between 2 models based on their specific need with lumen of 210 lm.

BENEFITS

- Up to 90% energy saving compared with traditional halogen lamps.
- Lower maintenance costs.
- Low initial investment.

FEATURES

- High CRI>90.
- Efficacy up to 105lm/w.
- Long life span 25,000 hrs.
- Wide operating voltage AC220 – 240V.
- Non – dimmable.
- UV – and IR – free light.

LED Non-Directional Lamp

Twilight

Technical Operating & Electrical Data

Input Voltage & Frequency	AC220-240V, 50/60Hz
Rated CRI	90
Lifespan	25,000h
Ingress Protection Rating	IP20
Dimming	Non Dimmable
Lamp Type	Indirect
Fixed or Adjustable	Fixed

Body Color Options



WH

Areas of Application

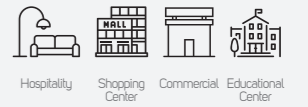

Dimensions Options

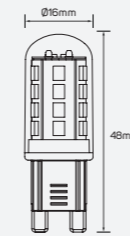

Family Product List

Code No.	Model No.	CRI	Power	Beam Angle	CCT	Lumen	Efficacy
612446	ILS210G9L927WW01	90	2W	320°	2700K	210lm	105lm/w



LED Filament Lamp

Twilight Wishes

Technical Operating & Electrical Data

Input Voltage & Frequency	AC220-240V, 50/60Hz
Rated CRI	92
Lifespan	15,000h
Ingress Protection Rating	IP20
Beam Angle	320°

Areas of Application

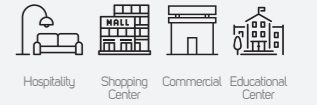

Body Color Options



Shape Options



Dimensions Options

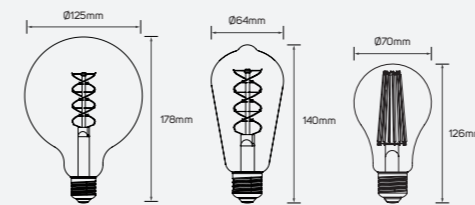

Twilight

PRODUCT INFORMATION

- Combines the familiar shapes of classic incandescent bulbs with long lasting LED technology.
- Delivers beautiful warm white light while saving energy costs compared with traditional light bulbs.
- ILLUS LED FILAMENT E27 Lamp gives the customer the flexibility to choose between 4 models based on their specific need with lumen package from 400 lm to 2500 lm.

BENEFITS

- 90% energy saving.
- Very long lifetime that reduces the need for replacement.
- Easy replacement of classic conventional lamps.

FEATURES

- High CRI>92.
- Efficacy up to 139 lm/w.
- Long life span 15,000 hrs.
- Operating voltage AC220 – 240V.

Family Product List

Code No.	Model No.	Power	CCT	Lumen	Efficacy
613431	ILS6.5WDG125E27L918WW01	6.5W	1800K	400lm	61.54lm/W
613429	ILS6.5WDST64E27L918WW01	6.5W	1800K	400lm	61.54lm/W
613397	ILS18A70E27L927WW01	18W	2700K	2500lm	138.89lm/W
613398	ILS18A70E27L927WW02	18W	2700K	2500lm	138.89lm/W

LED Filament Lamp

Dusk Delight

Technical Operating & Electrical Data

Input Voltage & Frequency	AC220-240V, 50/60Hz
Rated CRI	95
Lifespan	15,000h
Ingress Protection Rating	IP20
Dimming	Dimmable

Body Color Options

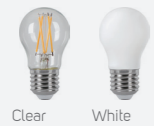

Clear White

Shape Options



Dimensions Options

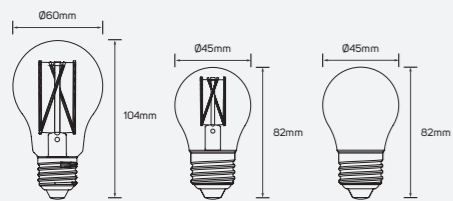

Family Product List

Code No.	Model No.	Power	Beam Angle	CCT	Lumen	Efficacy
● 614374	ILS4.7DFP45927WW01	4.7W	320°	2700K	480lm	102.13lm/W
● 614375	ILS7.2DFA60927WW02	7.2W	300°	2700K	800lm	111.11lm/W
○ 614376	ILS9DFA60927WW01	9W	300°	2700K	1080lm	120lm/W
● 614377	ILS4.7DFP45927WW02	4.7W	320°	2700K	510lm	108.51lm/W

Areas of Application

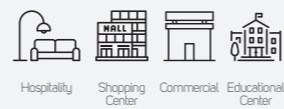



Led Filament Lamp E27

PRODUCT INFORMATION

Transforms your home with a perfect blend of warm white light and a lean.

- Distributed light with trendy and stylish charm for a welcoming harmony in your space.
- ILLUS LED FILAMENT Lamp gives the customer the flexibility to choose between 12 models based on their specific needs with lumen package from 480 lm to 1720 lm.

BENEFITS

- 90% energy saving.
- Very long lifetime that reduces the need for replacement.
- Easy replacement of classic conventional lamps.

FEATURES

- High CRI>95.
- Efficacy up to 164 lm/w.
- Long lifespan 30000H.
- Non-Dimmable.
- Wide operating voltage AC220-240V.
- Class-A filament bulb.

Led Filament Lamp E27

Spark

Technical Operating & Electrical Data

Input Voltage & Frequency	AC220-240V, 50/60Hz
IP Rating	IP20
Body Material	Glass
Rated CRI	95
Body Color	Clear
Beam Angle	320°
Dimming	Non-Dimmable
Lifespan	30000H
Switching Cycle	10000x on/off
Warranty Period	36 Months

Areas of Application

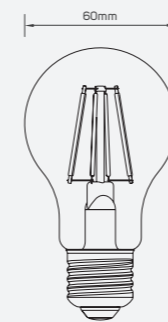
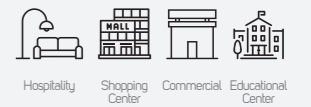

615136 - 615137

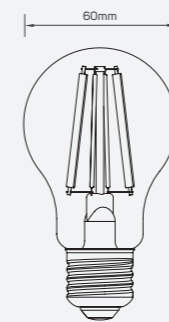

615136 - 615137

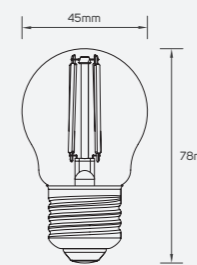

615136 - 615137

Family Product List

Code No.	Model No.	Power	Lumen	Efficacy	CCT	Current	Cap Type	Saving Energy	Equivalent
○ 615298	ILS7FA60E27A927WW01	7W	820lm	117.14lm/W	2700K	40mA	E27	89%	61W
○ 615299	ILS7FA60E27A930WW01	7W	840lm	120lm/W	3000K	40mA	E27	89%	62W
○ 615300	ILS7FA60E27A940NW01	7W	870lm	124.29lm/W	4000K	40mA	E27	89%	64W
○ 615301	ILS8.5FA60E27A927WW01	8.5W	1150lm	135.29lm/W	2700K	610mA	E27	89%	80W
○ 615302	ILS8.5FA60E27A930WW01	8.5W	1200lm	141.18lm/W	3000K	610mA	E27	90%	83W
○ 615303	ILS8.5FA60E27A940NW01	8.5W	1270lm	149.41lm/W	4000K	610mA	E27	90%	87W
○ 615304	ILS10.5FA60E27A927WW01	10.5W	1600lm	152.38lm/W	2700K	80mA	E27	90%	104W
○ 615305	ILS10.5FA60E27A930WW01	10.5W	1650lm	157.14lm/W	3000K	80mA	E27	90%	107W
○ 615306	ILS10.5FA60E27A940NW01	10.5W	1720lm	163.81lm/W	4000K	80mA	E27	91%	111W
○ 615310	ILS4.5FG45E27A927WW01	4.5W	480lm	106.67lm/W	2700K	40mA	E27	89%	41W
○ 615311	ILS4.5FG45E27A930WW01	4.5W	490lm	108.89lm/W	3000K	40mA	E27	89%	41W
○ 615312	ILS4.5FG45E27A940NW01	4.5W	510lm	113.33lm/W	4000K	40mA	E27	89%	42W



LED Filament E27 Lamp

Neon Nocturne

Technical Operating & Electrical Data

Input Voltage & Frequency	AC220-240V, 50/60Hz
Rated CRI	90
Lifespan	15,000h
Ingress Protection Rating	IP20
Dimming	Dimmable
Directional or Non Directional	Non-Directional
Fixed or Adjustable	Fixed

Body Color Options

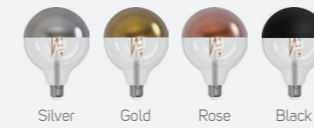

Shape Options



Dimensions Options

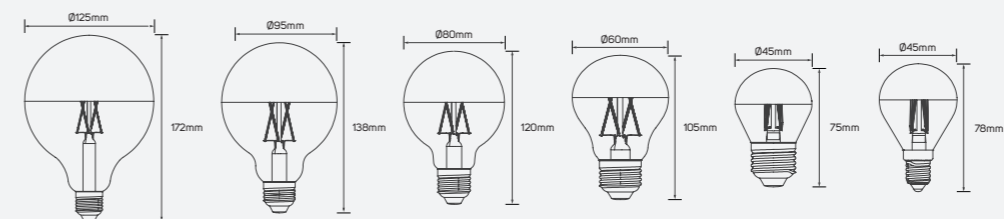

Areas of Application

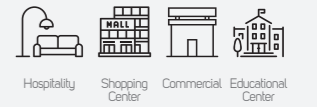

Midnight

PRODUCT INFORMATION

- LEDspots GU10 are designed as a retrofit replacement for halogen spots.
- Deliver significant energy savings and minimize initial investment.
- ILLUS LED GU10 lamp gives the customer the flexibility to choose between 28 models based on their specific need with lumen package from 400 lm to 900 lm.

BENEFITS

- Up to 90% energy saving compared with traditional halogen lamps.
- Lower maintenance costs.
- Low initial investment.

FEATURES

- High CRI>90.
- Efficacy up to 100 lm/w.
- Long life span 25,000h
- Operating voltage AC220 – 240V.
- Non – dimmable.
- UV – IR – free light.

Family Product List

Code No.	Model No.	Power	Beam Angle	CCT	Lumen	Efficacy
612705	ILS4.5WE14DFG45L927WWS01	4.5W	330°	2700K	400lm	89lm/W
612706	ILS4.5WE27DFG45L927WWS01	4.5W	330°	2700K	400lm	89lm/W
612707	ILS7WE27DFA60L927WWS01	7W	330°	2700K	680lm	97lm/W
612708	ILS9WE27DFA60L927WWS01	9W	330°	2700K	900lm	100lm/W
612709	ILS9WE27DFG80L927WWS01	9W	330°	2700K	900lm	100lm/W
612710	ILS9WE27DFG95L927WWS01	9W	330°	2700K	900lm	100lm/W
612711	ILS9WE27DFG125L927WWS01	9W	330°	2700K	900lm	100lm/W
612712	ILS4.5WE14DFG45L927WWG01	4.5W	330°	2700K	400lm	89lm/W
612713	ILS4.5WE27DFG45L927WWG01	4.5W	330°	2700K	400lm	89lm/W
612714	ILS7WE27DFA60L927WWG01	7W	330°	2700K	680lm	97lm/W
612715	ILS9WE27DFA60L927WWG01	9W	330°	2700K	900lm	100lm/W
612716	ILS9WE27DFG80L927WWG01	9W	330°	2700K	900lm	100lm/W
612717	ILS9WE27DFG95L927WWG01	9W	330°	2700K	900lm	100m/W
612718	ILS9WE27DFG125L927WWG01	9W	330°	2700K	900lm	100lm/W

Family Product List

Code No.	Model No.	Power	Beam Angle	CCT	Lumen	Efficacy
● 612719	ILS4.5WE14DFG45L927WWRG01	4.5W	330°	2700K	400lm	89lm/W
● 612720	ILS4.5WE27DFG45L927WWRG01	4.5W	330°	2700K	400lm	89lm/W
● 612721	ILS7WE27DFA60L927WWRG01	7W	330°	2700K	680lm	97lm/W
● 612722	ILS9WE27DFA60L927WWRG01	9W	330°	2700K	900lm	100lm/W
● 612723	ILS9WE27DFG80L927WWRG01	9W	330°	2700K	900lm	100lm/W
● 612724	ILS9WE27DFG95L927WWRG01	9W	330°	2700K	900lm	100lm/W
● 612725	ILS9WE27DFG125L927WWRG01	9W	330°	2700K	900lm	100lm/W
● 612726	ILS4.5WE14DFG45L927WWB01	4.5W	330°	2700K	400lm	89lm/W
● 612727	ILS4.5WE27DFG45L927WWB01	4.5W	330°	2700K	400lm	89lm/W
● 612728	ILS7WE27DFA60L927WWB01	7W	330°	2700K	680lm	97lm/W
● 612729	ILS9WE27DFA60L927WWB01	9W	330°	2700K	900lm	100lm/W
● 612730	ILS9WE27DFG80L927WWB01	9W	330°	2700K	900lm	100lm/W
● 612731	ILS9WE27DFG95L927WWB01	9W	330°	2700K	900lm	100lm/W
● 612732	ILS9WE27DFG125L927WWB01	9W	330°	2700K	900lm	100lm/W





LED Filament E27 Lamp

Midnight Aurora

Areas of Application

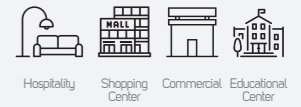

Technical Operating & Electrical Data

Input Voltage & Frequency	AC220-240V, 50/60Hz
Rated CRI	90
Lifespan	15,000h
Ingress Protection Rating	IP20
Dimming	Dimmable
Directional or Non Directional	Directional
Fixed or Adjustable	Fixed

Body Color Options



Glass

Shape Options



Dimensions Options

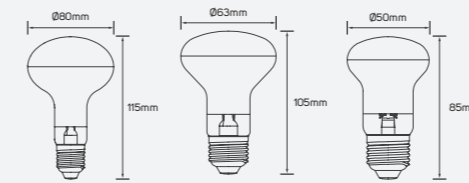

Midnight

PRODUCT INFORMATION

- Combines the familiar shapes of classic incandescent bulbs with long lasting LED technology.
- Delivers beautiful warm white light while saving energy costs compared with traditional light bulbs.
- ILLUS LED NON – DIRECTIONAL Lamp gives the customer the flexibility to choose between 3 models based on their specific need with lumen package from 330 lm to 560 lm.

BENEFITS

- Very long lifetime that reduces the need for replacement.
- Easy replacement of classic conventional lamps.

FEATURES

- High CRI>90.
- Efficacy up to 80 lm/w.
- Long life span 15,000 hrs.
- Operating voltage AC220 – 240V.
- Dimmable.

Family Product List

Code No.	Model No.	Power	Beam Angle	CCT	Lumen	Efficacy
612734	ILS4.5WE27DFR50L927WW01	4.5W	60°	2700K	330lm	73lm/W
612735	ILS7WE27DFR63L927WW01	7W	60°	2700K	560lm	80lm/W
612736	ILS7WE27DFR80L927WW01	7W	60°	2700K	560lm	80lm/W



Led Filament Lamp E14

PRODUCT INFORMATION

- Transforms your home with a perfect blend of warm white light and a lean.
- Distributed light with trendy and stylish charm for a welcoming harmony in your space.
- ILLUS LED FILAMENT Lamp gives the customer the flexibility to choose between 3 models based on their specific need with lumen package from 480 lm to 510lm.

BENEFITS

- 89% energy saving.
- Very long lifetime that reduces the need for replacement.
- Easy replacement of classic conventional lamps.

FEATURES

- High CRI>95.
- Efficacy up to 113lm/w.
- Long lifespan 30000 H.
- Wide operating voltage
- Non-Dimmable.
- Class-A filament lamp.

Led Filament Lamp E14

Bliss

Technical Operating & Electrical Data

Input Voltage & Frequency	AC220-240V, 50/60Hz
IP Rating	IP20
Body Material	Glass
Rated CRI	95
Body Color	Clear
Beam Angle	320°
Dimming	Non-Dimmable
Lifespan	30000H
Switching Cycle	100000x on/off
Warranty Period	36 Months

Areas of Application

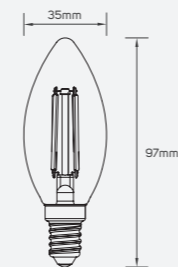

615136 - 615137

Family Product List

Code No.	Model No.	Power	Lumen	Efficacy	CCT	Current	Cap Type	Saving Energy	Equivalent
○ 615307	ILS4.5FC35E14A927WW01	4.5W	480lm	106.67lm/W	2700K	40mA	E14	89%	41W
○ 615308	ILS4.5FC35E14A930WW01	4.5W	490lm	108.89lm/W	3000K	40mA	E14	89%	41W
○ 615309	ILS4.5FC35E14A940NW01	4.5W	510lm	113.33lm/W	4000K	40mA	E14	89%	42W



Twinkle

PRODUCT INFORMATION

- A clever energy efficient addition to any home.
- Thanks to a built-in sensor, this modern LED lamp can detect when you walk close by and turn on automatically.
- ILLUS MICROWAVE LED E27 Lamp gives the customer the flexibility to choose between 9 models based on their specific need with lumen package from 570 lm to 1210 lm.

BENEFITS

- Equipped with a daylight sensor that turns your light bulb on automatically in darkness.
- Very long lifetime that reduces the need for replacement.
- Easy replacement of classic conventional lamps.

FEATURES

- High CRI>80.
- Efficacy up to 125 lm/w.
- Long life span 15,000 hrs.
- Operating voltage AC220 – 240V.
- Non – dimmable.

LED Filament Lamp (PIR Sensor)

Velvet Visions

Technical Operating & Electrical Data

Input Voltage & Frequency	AC220-240V, 50/60Hz
Rated CRI	80
Lifespan	15,000h
Ingress Protection Rating	IP20
Dimming	Non- Dimmable
Directional or Non Directional	Non-Directional

Body Color Options



White

Dimensions Options

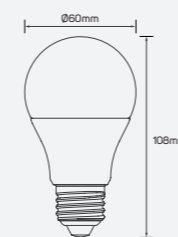

Areas of Application

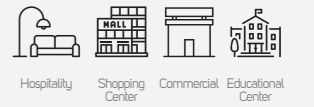

Family Product List

Code No.	Model No.	Power	Beam Angle	CCT	Lumen	Efficacy
614120	ILS4.8A60MCOE27FL830WW01	4.8W	200°	3000K	570lm	119lm/W
614121	ILS4.8A60MCOE27FL840NW01	4.8W	200°	4000K	580lm	121lm/W
614122	ILS4.8A60MCOE27FL850DL01	4.8W	200°	5000K	600lm	125lm/W
614123	ILS8.5A60MCOE27FL830WW01	8.5W	240°	3000K	880lm	104lm/W
614124	ILS8.5A60MCOE27FL840NW01	8.5W	240°	4000K	900lm	106lm/W
614125	ILS8.5A60MCOE27FL850DL01	8.5W	240°	5000K	950lm	112lm/W
614126	ILS10A60MCOE27FL830WW01	10W	240°	3000K	1150lm	115lm/W
614127	ILS10A60MCOE27FL840NW01	10W	240°	4000K	1170lm	117lm/W
614128	ILS10A60MCOE27FL850DL01	10W	240°	5000K	1210lm	121lm/W

EtherealTwinkle

Technical Operating & Electrical Data

Input Voltage & Frequency	AC220-240V, 50/60Hz
Rated CRI	80
Lifespan	15,000h
Ingress Protection Rating	IP20
Dimming	Non- Dimmable
Directional or Non Directional	Non-Directional

Body Color Options



Clear

Dimensions Options

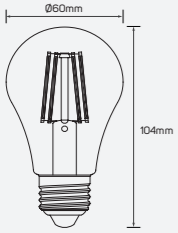

Family Product List

Code No.	Model No.	Power	Beam Angle	CCT	Lumen	Efficacy
○ 614129	ILS7.5A60SOSE27FL830WW01	7.5W	320°	3000K	1120lm	149lm/W
○ 614130	ILS7.5A60SOSE27FL840NW01	7.5W	320°	4000K	1140lm	152lm/W
○ 614131	ILS7.5A60SOSE27FL850DL01	7.5W	320°	5000K	1170lm	156lm/W
○ 614132	ILS6.5A60SOSE27FL830WW01	6.5W	320°	3000K	960lm	148lm/W
○ 614133	ILS6.5A60SOSE27FL840NW01	6.5W	320°	4000K	970lm	149lm/W
○ 614134	ILS6.5A60SOSE27FL850DL01	6.5W	320°	5000K	990lm	152lm/W

Areas of Application

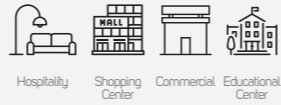



ModernGlow

LED T8 Glass Tube Light

ModernGlow

Areas of Application

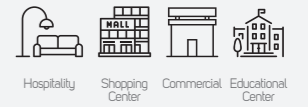

Technical Operating & Electrical Data

Input Voltage & Frequency	AC220-240V, 50/60Hz
Rated CRI	80
Lifespan	15,000h
Ingress Protection Rating	IP20
Body Material	Plastic

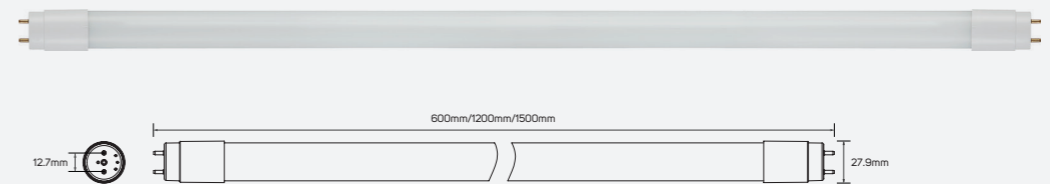

Family Product List

Code No.	Power	CCT	Lumen	Code No.	Power	CCT	Lumen
612481	9W	3000K	900lm	612487	24W	3000K	2260lm
612482	9W	4000K	930lm	612488	24W	4000K	2290lm
612483	9W	6500K	940lm	612489	24W	6500K	2330lm
612484	18W	3000K	1820lm				
612485	18W	4000K	1840lm				
612486	18W	6500K	1870lm				

ModernGlow

Technical Operating & Electrical Data

Input Voltage & Frequency	AC220-240V, 50/60Hz
Rated CRI	92
Lifespan	30,000h
Ingress Protection Rating	IP20
Body Material	Aluminum+Plastic
Beam Angle	160°

Areas of Application

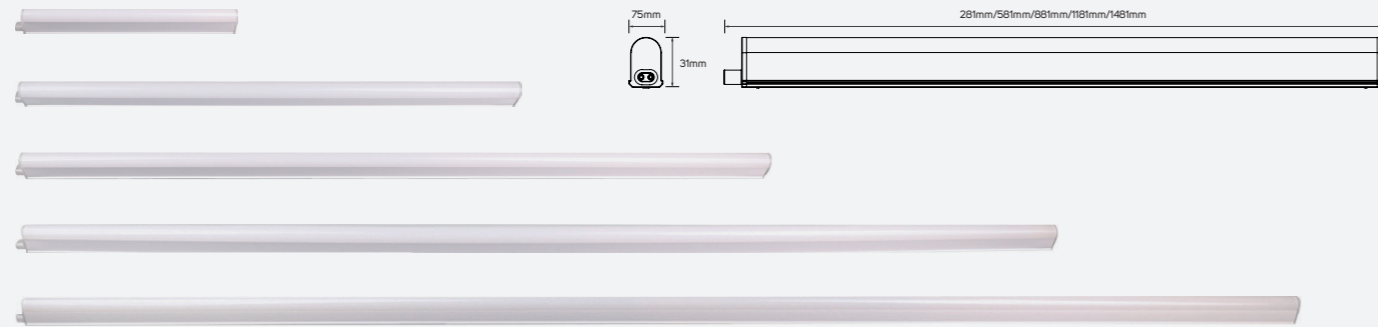
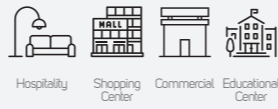

Family Product List

Code No.	Power	CCT	Lumen	Code No.	Power	CCT	Lumen
612425	5W	2700K	490lm	612437	18.5W	2700K	1730lm
612426	5W	3000K	505lm	612438	18.5W	3000K	1760lm
612427	5W	4000K	530lm	612439	18.5W	4000K	1840lm
612428	5W	5000K	540lm	612440	18.5W	5000K	1860lm
612429	9W	2700K	880lm	612441	24W	2700K	2180lm
612430	9W	3000K	890lm	612442	24W	3000K	2250lm
612431	9W	4000K	940lm	612443	24W	4000K	2400lm
612432	9W	5000K	970lm	612444	24W	5000K	2420lm
612433	14.5W	2700K	1370lm				
612434	14.5W	3000K	1380lm				
612435	14.5W	4000K	1450lm				
612436	14.5W	5000K	1460lm				

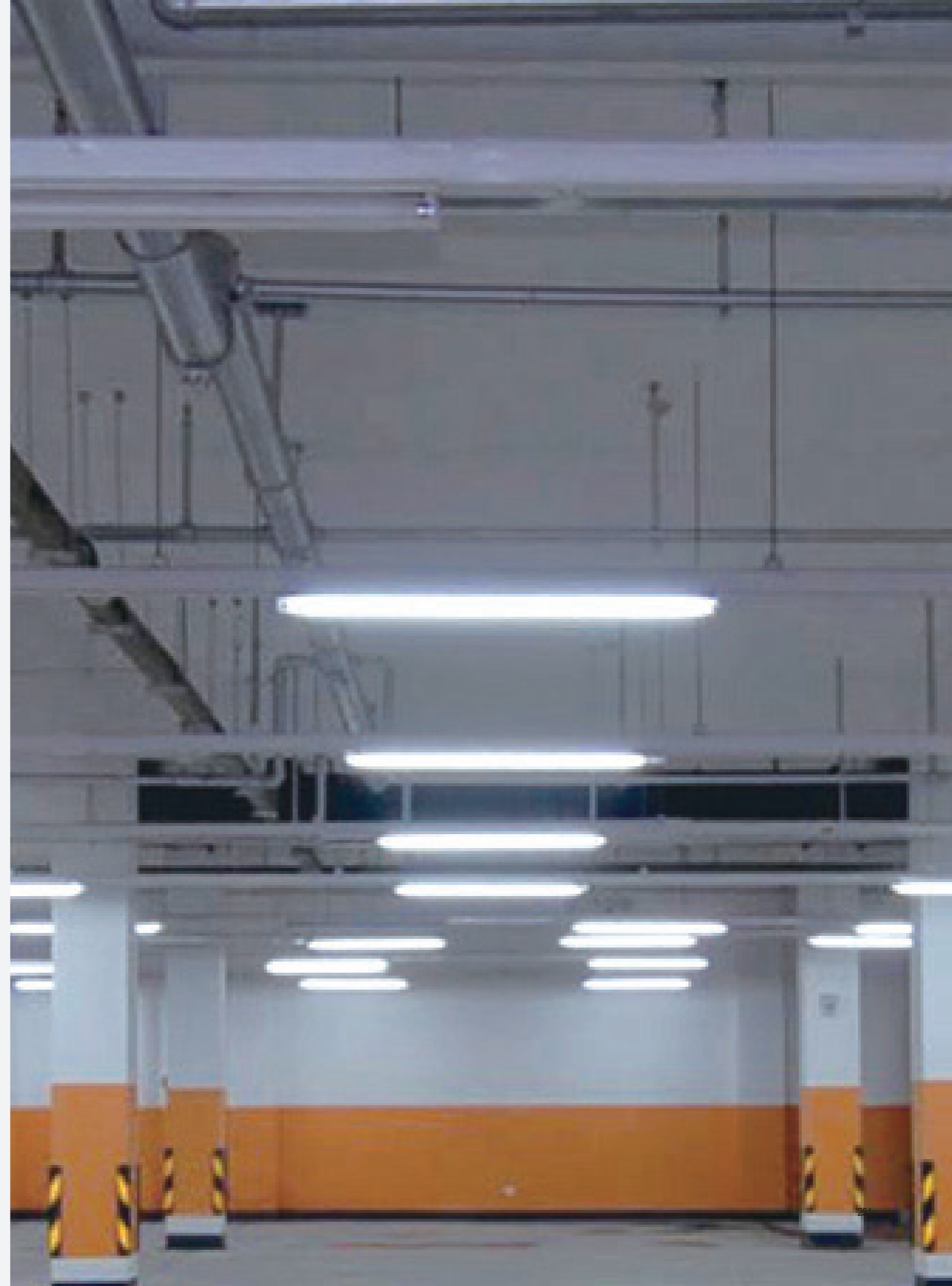

Frames/Housing

- Frame
- Gypsum Frame



Frame

Modern

Technical Operating & Electrical Data

Body Material	Aluminum
IP Rating	IP20
Lamp Holder Type	MR16

Areas of Application

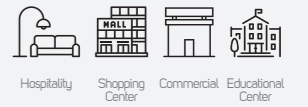

Dimensions Options

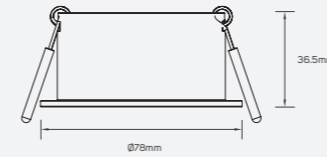

Accessories

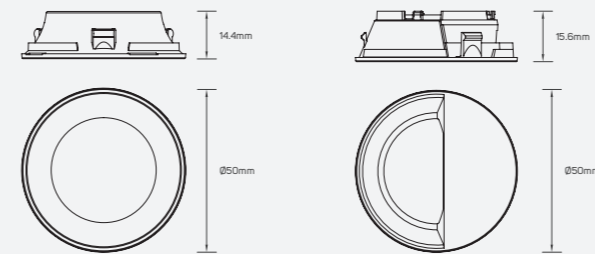

LI615588

LI615589

Family Product List

Code No.	Model No.	Body Color	Cutting Size
LI615587	ILS78PFRMW01	white	Ø70MM

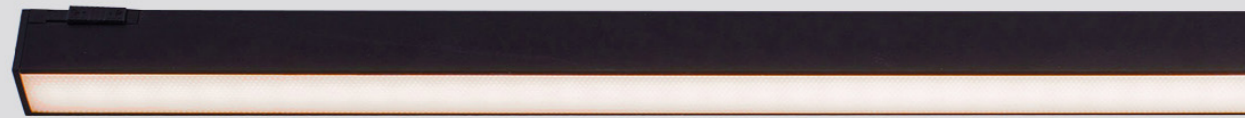

Frame

Perpetual

Areas of Application



Technical Operating & Electrical Data

Input Voltage & Frequency	AC220-240V, 50/60Hz
Body Material	die-casting aluminum
IP Rating	IP65
Lamp Holder Type	GU10



Dimensions Options



613064 - 613065

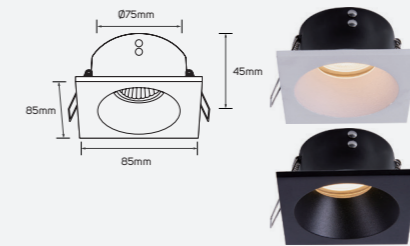

613066 - 613067



613068 - 613069

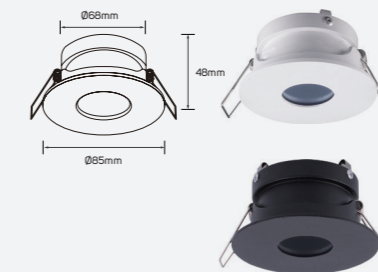

613070 - 613071

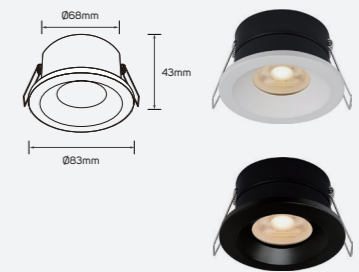

613072 - 613073

Family Product List

Code No.	Model No.	Body Color
● 613064	ILS085RRFW01	white
● 613065	ILS085RRFB01	black
● 613066	ILS085SRFW01	white
● 613067	ILS085SRFB01	black
● 613068	ILS087RRFW01	white
● 613069	ILS087RRFB01	black
● 613070	ILS084RRFW01	white
● 613071	ILS084RRFB01	black
● 613072	ILS083RRFW01	white
● 613073	ILS083RRFB01	black



Frame

Pioneer G1

Areas of Application

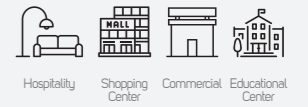

Technical Operating & Electrical Data

Input Voltage & Frequency	AC220-240V, 50/60Hz
Body Material	Aluminum
Lamp Type Compatibility	GU10



Dimensions Options

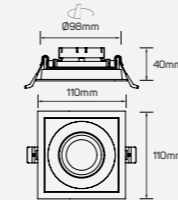

5101012-5101050

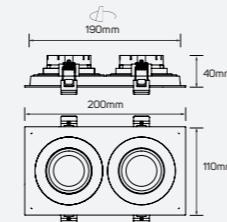
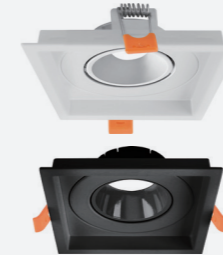

5101013-5101051



Family Product List

Code No.	Model No.	Body Color	Mounting Dimensions
● 5101012	ILS110SFW01	white	98x98mm
● 5101013	ILS210SFW01	white	98x190mm
● 5101050	ILS110SFB01	black	98x98mm
● 5101051	ILS210SFB01	black	190x98mm

Frame

Pioneer G1

Technical Operating & Electrical Data

Input Voltage & Frequency	AC220-240V, 50/60Hz
Body Material	Steel Housing & Die Cast Aluminum Rings
IP Rating	IP20
Lamp Holder Type	GU10
Directional or Non Directional	Non Directional
Fixed or Adjustable	Adjustable
Wattage	Max. 9W
Mounting Type	Recessed luminaire

Dimensions Options



Areas of Application

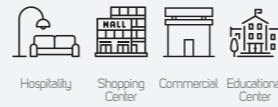

Family Product List

Code No.	Model No.	Body Color	Cutting Size
● 612595	ILSARCF01	black	Ø98mm

Frame

Pioneer G1

Technical Operating & Electrical Data

Input Voltage & Frequency	AC220-240V, 50/60Hz
Body Material	Aluminum
Lamp Holder Type	MR11

Dimensions Options

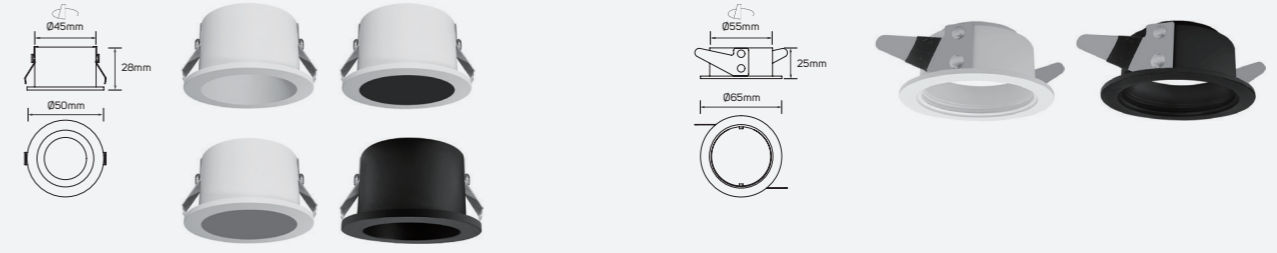

5101671 - 5101672 - 5101673 - 5101674

5101675 - 5101676

Reflector Options



5101677 - 5101678 - 5101679 - 5101680 - 5101681

Family Product List

Code No.	Model No.	Body Color	Cutting Size
● 5101671	ILS50FRCFMR11W01	white	Ø45mm
● 5101672	ILS50FRCFMR11WB01	white+black	Ø45mm
● 5101673	ILS50FRCFMR11WG01	white	Ø45mm
● 5101674	ILS50FRCFMR11B01	black	Ø45mm
● 5101675	ILS65FRCFMR11ORW01	white	Ø55mm
● 5101676	ILS65FRCFMR11ORB01	black	Ø55mm

Reflector Specifications

Code No.	Model No.	Body Color
● 5101677	ILS50FRCFMR11IRW01	white
● 5101678	ILS50FRCFMR11IRB01	black
● 5101679	ILS50FRCFMR11IRB02	chrome black
● 5101680	ILS50FRCFMR11IRS01	anti-glare silver
● 5101681	ILS50FRCFMR11IRRG01	rosy gold

Areas of Application



Frame

Pioneer G1

Technical Operating & Electrical Data

Input Voltage & Frequency	AC220-240V, 50/60Hz
Body Material	Aluminum
Lamp Holder Type	MR11

Dimensions Options

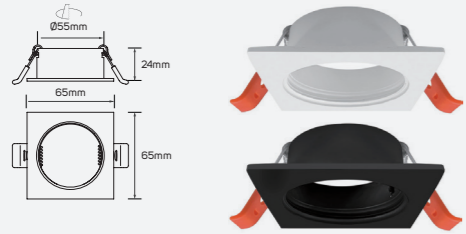

5101682 - 5101683

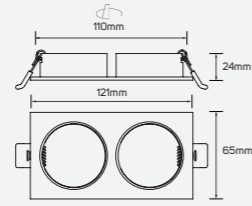

5101684 - 5101685



Reflector Options



5101677 - 5101678 - 5101679 - 5101680 - 5101681

Family Product List

Code No.	Model No.	Body Color	Cutting Size
● 5101682	ILS65FSCFMR11ORW01	white	Ø55mm
● 5101683	ILS65FSCFMR11ORB01	black	Ø55mm
● 5101684	ILS65FSCFMR11ORW02	white	110x55mm
● 5101685	ILS65FSCFMR11ORB02	black	110x55mm

Reflector Specifications

Code No.	Model No.	Body Color	Cutting Size
● 5101677	ILS50FRCFMR11IRW01	white	
● 5101678	ILS50FRCFMR11IRB01	black	
● 5101679	ILS50FRCFMR11IRB02	chrome black	
● 5101680	ILS50FRCFMR11IRS01	anti-glare silver	
● 5101681	ILS50FRCFMR11IRRG01	rosy gold	

Areas of Application

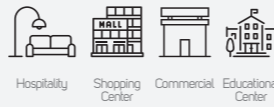

Frame

Pioneer G1

Technical Operating & Electrical Data

Input Voltage & Frequency	AC220-240V, 50/60Hz
Body Material	Aluminum
Lamp Holder Type	MR11

Dimensions Options

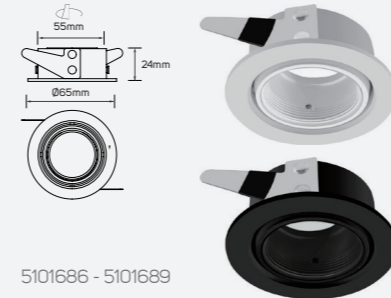

5101686 - 5101689

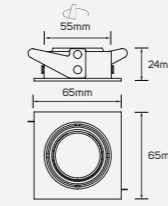

5101687 - 5101690

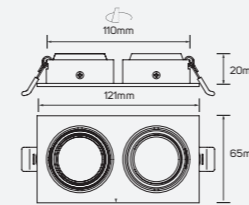

5101688 - 5101691



Reflector Options



5101692 - 5101693 - 5101694 - 5101695 - 5101696

Family Product List

Code No.	Model No.	Body Color	Cutting Size
● 5101686	ILS65ARCFMR11ORW01	white	Ø55mm
● 5101687	ILS65ASCFMR11ORW01	white	Ø55mm
● 5101688	ILS121ASCFMR11ORW01	white	110x55mm
● 5101689	ILS65ARCFMR11ORB01	black	Ø55mm
● 5101690	ILS65ASCFMR11ORB01	black	Ø55mm
● 5101691	ILS121ASCFMR11ORB01	black	110x55mm

Areas of Application

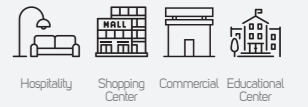

Reflector Specifications

Code No.	Model No.	Body Color	Cutting Size
● 5101692	ILS37FRCFMR11IRW01	white	
● 5101693	ILS37FRCFMR11IRB01	black	
● 5101694	ILS37FRCFMR11IRB02	anti-glare black	
● 5101695	ILS37FRCFMR11IRS01	anti-glare silver	
● 5101696	ILS37FRCFMR11IRRG01	rosy gold	



Frame

Pioneer G2

Technical Operating & Electrical Data

Input Voltage & Frequency	AC220-240V, 50/60Hz
Body Material	Aluminum
IP Rating	IP20



5101059-5101231

Dimensions

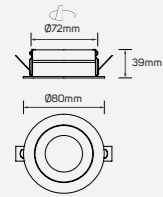

Family Product List

Code No.	Model No.	Mounting Dimensions
● 5101059	ILS080SFW01	Ø72mm
● 5101231	ILS080SFWB01	Ø72mm
▮ 5101232	ILS080SFWB02	Ø72mm

Areas of Application

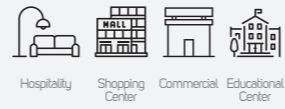

Frame

Pioneer G2

Technical Operating & Electrical Data

Input Voltage & Frequency	AC220-240V, 50/60Hz
Body Material	Aluminum
IP Rating	IP20



5101380-5101381

Dimensions

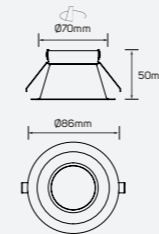

Family Product List

Code No.	Model No.	Mounting Dimensions
● 5101380	ILS85FRCFR01	Ø70mm
● 5101381	ILS85FRCFR01	Ø70mm

Areas of Application

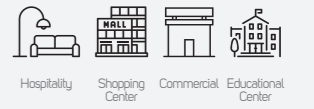



Frame

Pioneer G2

Technical Operating & Electrical Data

Input Voltage & Frequency	AC220-240V, 50/60Hz
Body Material	Aluminum
IP Rating	IP20

Areas of Application

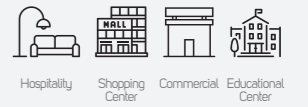

Dimensions

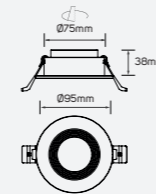

Family Product List

Code No.	Model No.	Mounting Dimensions
5101163	ILS090SFW02	Ø80mm

Frame

Pioneer G2

Technical Operating & Electrical Data

Input Voltage & Frequency	AC220-240V, 50/60Hz
Body Material	Aluminum
IP Rating	IP20

Areas of Application

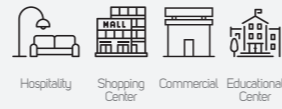

Dimensions

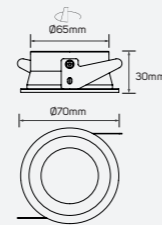

Family Product List

Code No.	Model No.	Mounting Dimensions
5101291	ILS07OSFW01	Ø65mm

Frame

Pioneer G2

Technical Operating & Electrical Data

Input Voltage & Frequency	AC220-240V, 50/60Hz
Body Material	Aluminum
IP Rating	IP20

Areas of Application

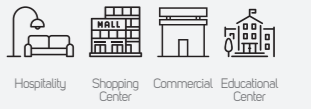

Dimensions

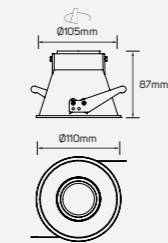

Family Product List

Code No.	Model No.	Mounting Dimensions
5101357	ILS110ARCFR01	Ø105mm
5101358	ILS110ARCFR01	Ø105mm

Frame

Pioneer G2

Technical Operating & Electrical Data

Input Voltage & Frequency	AC220-240V, 50/60Hz
Body Material	Aluminum
IP Rating	IP20

Areas of Application

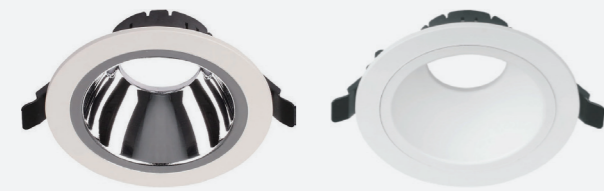
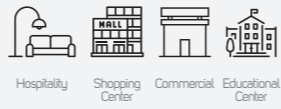

Dimensions

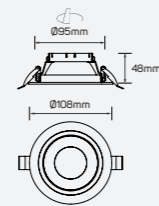

Family Product List

Code No.	Model No.	Mounting Dimensions
5101014	ILS96ARCFR02	Ø95mm
5101015	ILS96ARCFR03	Ø95mm

Frame

Pioneer G2

Technical Operating & Electrical Data

Input Voltage & Frequency	AC220-240V, 50/60Hz
Body Material	Aluminum
IP Rating	IP20

Areas of Application

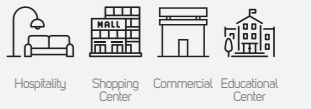

614269

Dimensions

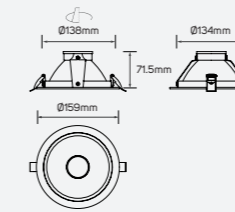

614271

Dimensions

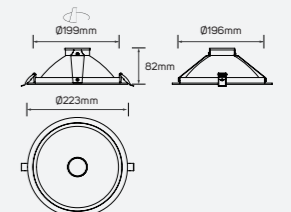

Family Product List

Code No.	Model No.	Mounting Dimensions
614269	ILS140REFRFB01	Ø138mm
614271	ILS200REFRFB01	Ø199mm

Frame

Pioneer G2

Areas of Application

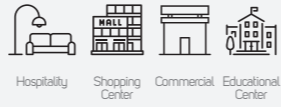

Technical Operating & Electrical Data

Input Voltage & Frequency	AC220-240V, 50/60Hz
Body Material	Aluminum
IP Rating	IP20



Dimensions

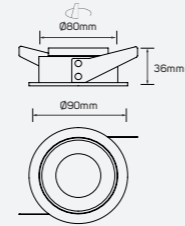

Family Product List

Code No.	Model No.	Mounting Dimensions
5101225	ILS090SFWB04	Ø80mm
5101226	ILS090SFWs05	Ø80mm
5101227	ILS090SFB01	Ø80mm



Dimensions

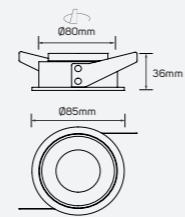

Family Product List

Code No.	Model No.	Mounting Dimensions
5101374	ILS085SFWB03	Ø80mm
5101375	ILS085SFWB03	Ø80mm
5101376	ILS085SFWB03	Ø80mm

Frame

Pioneer G2

Areas of Application

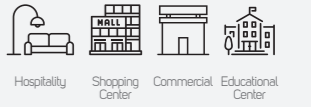

Technical Operating & Electrical Data

Input Voltage & Frequency	AC220-240V, 50/60Hz
Body Material	Aluminum
IP Rating	IP20



Dimensions

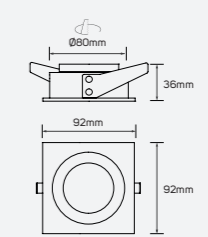

Family Product List

Code No.	Model No.	Mounting Dimensions
5101228	ILS090SFWB05	Ø80mm
5101229	ILS090SFWB05	Ø80mm
5101230	ILS090SFWB05	Ø80mm



Dimensions

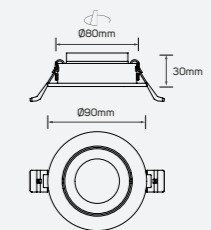

Family Product List

Code No.	Model No.	Mounting Dimensions
5101233	ILS090SFWB06	Ø80mm
5101234	ILS090SFWs07	Ø80mm
5101235	ILS090SFB03	Ø80mm

Frame

Pioneer G2

Technical Operating & Electrical Data

Input Voltage & Frequency	AC220-240V, 50/60Hz
Body Material	Aluminum
IP Rating	IP20



Dimensions

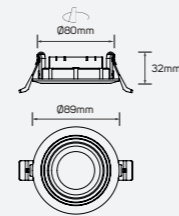

Family Product List

Code No.	Model No.	Mounting Dimensions
▶ 5101236	ILS089SFWB01	Ø80mm
▶ 5101237	ILS089SFW01	Ø80mm
● 5101238	ILS089SFB02	Ø80mm



Dimensions

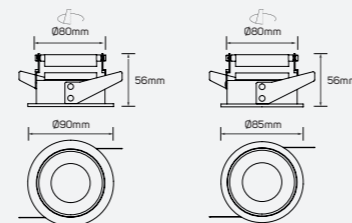

Family Product List

Code No.	Model No.	Mounting Dimensions
▶ 5101249	ILS090SFWB07	Ø80mm
● 5101250	ILS090SFW08	Ø80mm
● 5101251	ILS090SFB04	Ø80mm

Areas of Application

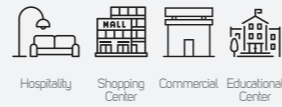

Frame

Pioneer G2

Technical Operating & Electrical Data

Input Voltage & Frequency	AC220-240V, 50/60Hz
Body Material	Aluminum
IP Rating	IP20



Dimensions

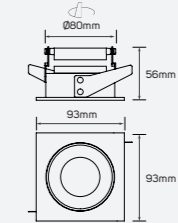

Family Product List

Code No.	Model No.	Mounting Dimensions
▶ 5101252	ILS090SFWB08	Ø80mm
● 5101253	ILS090SFW09	Ø80mm
● 5101254	ILS090SFB05	Ø80mm



Dimensions

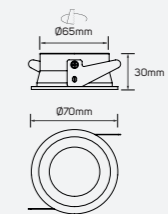

Family Product List

Code No.	Model No.	Mounting Dimensions
● 5101292	ILS070SFB01	Ø65mm
● 5101293	ILS070SFS01	Ø65mm

Areas of Application

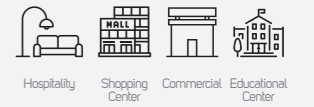

Frame

Pioneer G3

Technical Operating & Electrical Data

Input Voltage & Frequency	AC220-240V, 50/60Hz
Body Material	Aluminum
IP Rating	IP20

Areas of Application

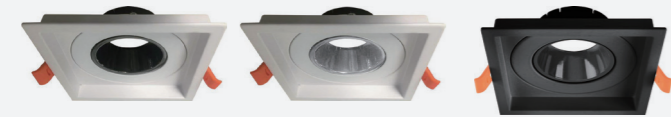
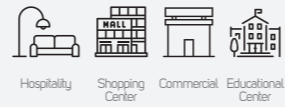

Dimensions

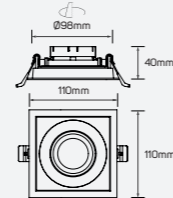

Family Product List

Code No.	Model No.	Mounting Dimensions
▶ 5101239	ILS110SFWB01	Ø98mm
▶ 5101240	ILS110SFWs01	Ø98mm
● 5101384	ILS110FRCFR01	190x98mm

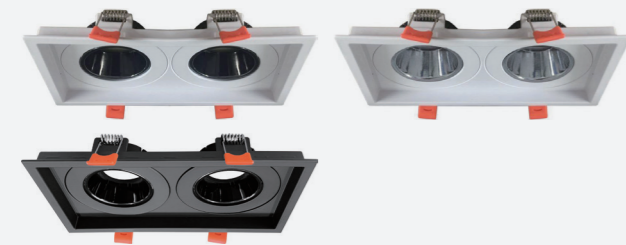

Dimensions

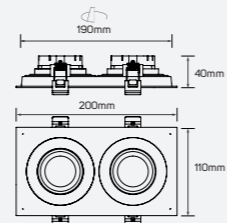

Family Product List

Code No.	Model No.	Mounting Dimensions
▶ 5101241	ILS200SFWB01	190x98mm
▶ 5101242	ILS200SFWs01	190x98mm
● 5101385	ILS200FRCFR01	190x98mm

Frame

Pioneer G3

Technical Operating & Electrical Data

Input Voltage & Frequency	AC220-240V, 50/60Hz
Body Material	Aluminum
IP Rating	IP20

Areas of Application

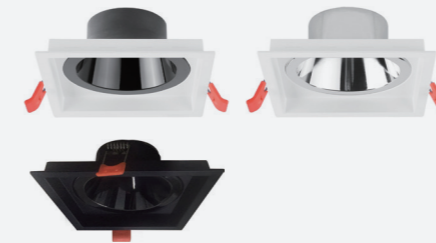
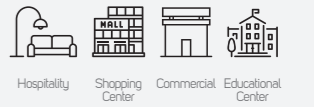

Dimensions

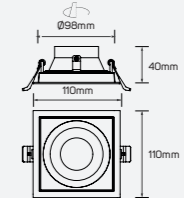

Family Product List

Code No.	Model No.	Mounting Dimensions
▶ 5101243	ILS110SFWB02	Ø98mm
▶ 5101244	ILS110SFWs02	Ø98mm
● 5101245	ILS110SFB02	Ø98mm



Dimensions

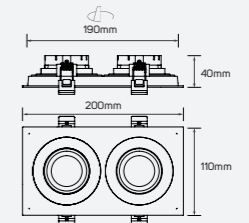

Family Product List

Code No.	Model No.	Mounting Dimensions
▶ 5101246	ILS200SFWB02	Ø80mm
▶ 5101247	ILS200SFWs02	Ø80mm
● 5101248	ILS200SFB02	Ø80mm

Frame

Pioneer G4

Technical Operating & Electrical Data

Input Voltage & Frequency	AC220-240V, 50/60Hz
Body Material	Aluminum
IP Rating	IP20

Areas of Application

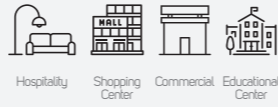

Dimensions

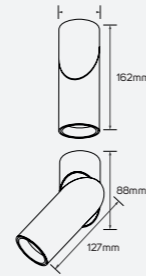

Family Product List

Code No.	Model No.	Maximum Wattage
● 613062	ILSASMCF01	Max.20
● 613063	ILSASMCF01	Max.20

Frame

Pioneer G5

Technical Operating & Electrical Data

Input Voltage & Frequency	AC220-240V, 50/60Hz
Body Material	Aluminum
IP Rating	IP20

Areas of Application

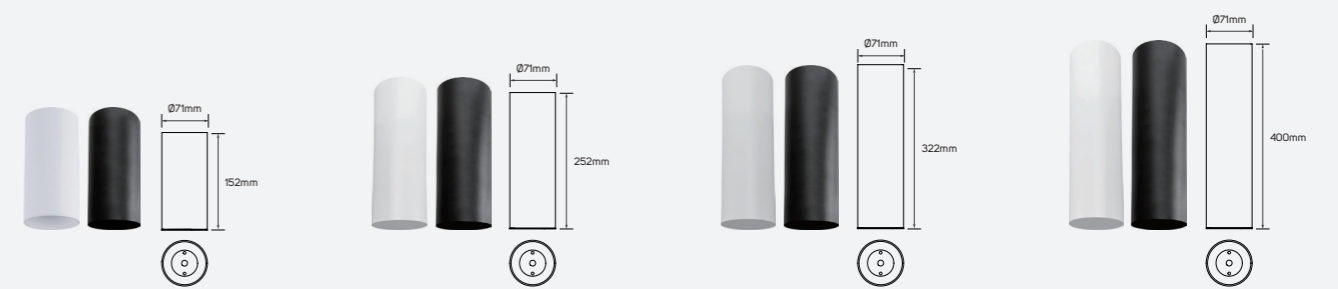
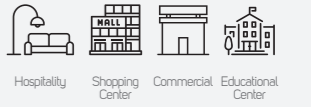

Family Product List

Code No.	Model No.
● 5101318	ILSSMSFW06
● 5101319	ILSSMSFB06



Frame

Pioneer P

Technical Operating & Electrical Data

Input Voltage & Frequency	AC220-240V, 50/60Hz
Body Material	Aluminum+Polycarbonate
IP Rating	IP20

Areas of Application



Dimensions

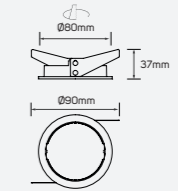

Reflector

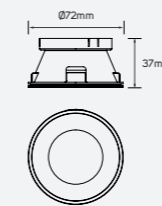

- 5101395
- 5101396
- 5101397
- 5101398
- 5101399
- 5101400
- 5101401

■ Polycarbonate

Honeycomb Holder



- 5101465
- Polycarbonate

Honeycomb

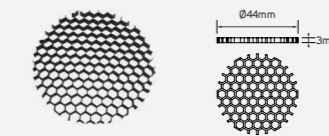

- 5101466
- Aluminum

Family Product List

Code No.	Model No.	Mounting Dimensions
● 5101393	ILS090FRCFR01	Ø80mm
● 5101394	ILS090FRCFR01	Ø80mm

Frame

Pioneer P

Technical Operating & Electrical Data

Input Voltage & Frequency	AC220-240V, 50/60Hz
Body Material	Aluminum+PC lamp holder
IP Rating	IP20

Areas of Application

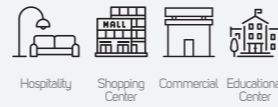

Dimensions

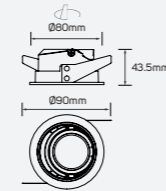

Reflector

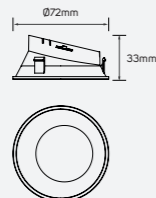

- 5101404
- 5101405
- 5101406
- 5101407
- 5101408
- 5101409
- 5101410

Honeycomb Holder

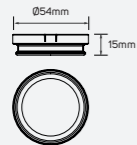

● 5101465

■ Polycarbonate

Honeycomb

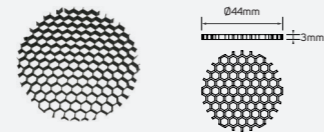

● 5101466

■ Aluminum

Family Product List

Code No.	Model No.	Mounting Dimensions
● 5101402	ILS090ARCFR01	Ø80mm
● 5101403	ILS090ARCFR01	Ø80mm

Frame

Pioneer P

Technical Operating & Electrical Data

Input Voltage & Frequency	AC220-240V, 50/60Hz
Body Material	Aluminum+Polycarbonate
IP Rating	IP20

Areas of Application

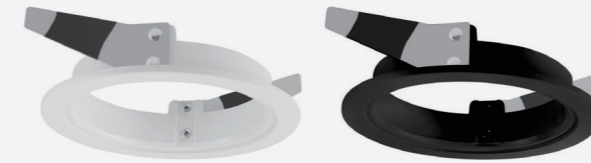
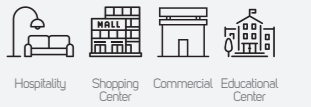

Dimensions

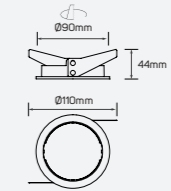

Reflector

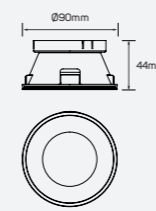
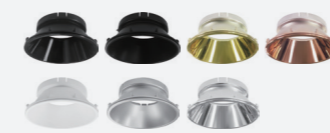

- 5101413
- 5101414
- 5101415
- 5101416
- 5101417
- 5101418
- 5101419

■ Polycarbonate

Honeycomb Holder

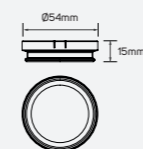

● 5101465

■ Polycarbonate

Honeycomb

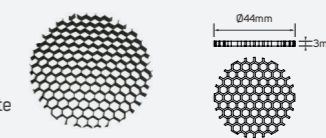

● 5101466

■ Aluminum

Family Product List

Code No.	Model No.	Mounting Dimensions
● 5101411	ILS110FRFCFR02	Ø90mm
● 5101412	ILS110FRFCFR02	Ø90mm

Frame

Pioneer P

Technical Operating & Electrical Data

Input Voltage & Frequency	AC220-240V, 50/60Hz
Body Material	Aluminum+PC lamp holder
IP Rating	IP20

Areas of Application

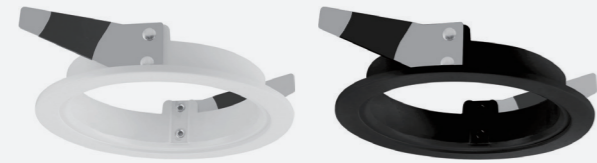
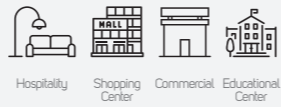

Dimensions

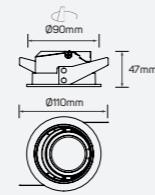

Reflector

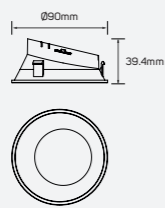
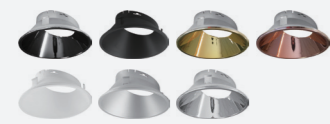

● 5101422	● 5101426	■ Polycarbonate
● 5101423	● 5101427	
● 5101424	● 5101428	
● 5101425		

Honeycomb Holder



● 5101465

■ Polycarbonate

Honeycomb

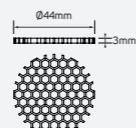
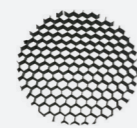

● 5101466

■ Aluminum

Family Product List

Code No.	Model No.	Mounting Dimensions
● 5101420	ILS110ARCFR02	Ø90mm
● 5101421	ILS110ARCFR02	Ø90mm

Frame

Pioneer P

Technical Operating & Electrical Data

Input Voltage & Frequency	AC220-240V, 50/60Hz
Body Material	Aluminum+PC lamp holder
IP Rating	IP20

Areas of Application

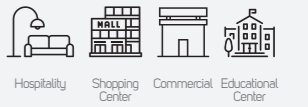

5101704

Dimensions

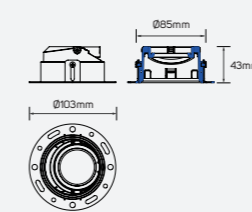

5101705

Dimensions

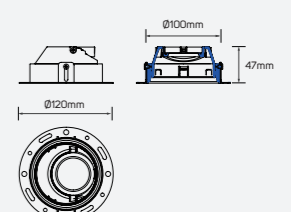

Family Product List

■ Aluminum+PC

Code No.	Model No.
● 5101704	ILS103TLFRMWB01
● 5101705	ILS113TLFRMWB01



5101706

Dimensions

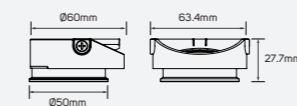

5101707

Dimensions

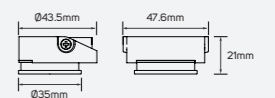

Family Product List

■ PC

Code No.	Model No.
● 5101706	ILS64CONVRCF01
● 5101707	ILS47CONVRCF01



Frame

Pioneer Q

Technical Operating & Electrical Data

Body Material	Aluminum+PC lamp holder
Cap Type	GU10&Mr16 & GUPO Module
IP Rating	IP20
Fixed or Adjustable	Fixed

Areas of Application



Dimensions

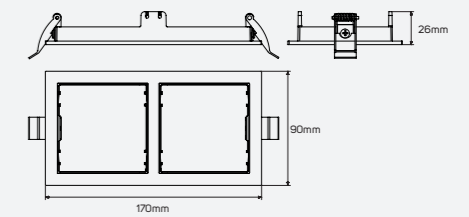

Reflector

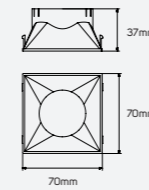
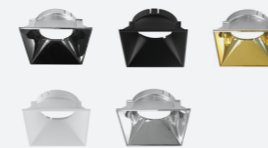

- 5101710
- 5101711
- 5101712

- 5101713
- 5101714

■ Aluminum +PC

Family Product List

Code No.	Model No.	Mounting Dimensions
● 5101708	ILS090FRCFRW01	160x80mm
● 5101709	ILS090FRCFRB01	160x80mm

Frame

Pioneer Q

Areas of Application

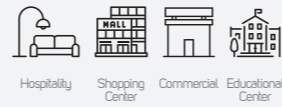

Technical Operating & Electrical Data

Body Material	Aluminum+PC lamp holder
Cap Type	GU10&Mr16 & GUPO Module
IP Rating	IP20
Fixed or Adjustable	Fixed



Dimensions

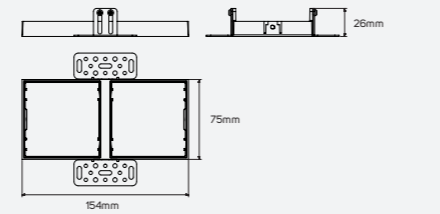

Reflector

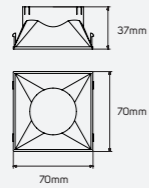
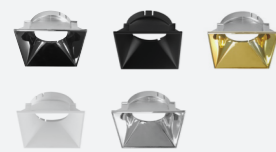

- 5101717
- 5101718
- 5101719
- 5101720
- 5101721
- Aluminum +PC

Family Product List

Code No.	Model No.	Mounting Dimensions
● 5101715	ILS122FRFCRW01	154x75mm
● 5101716	ILS122FRFCRB01	154x75mm

Frame

Pioneer R

Areas of Application

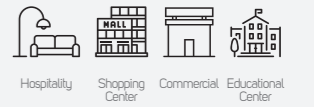

Technical Operating & Electrical Data

Body Material	Aluminum
Cap Type	GU10&Mr16 & GUPO Module
Fixed or Adjustable	Fixed



Dimensions

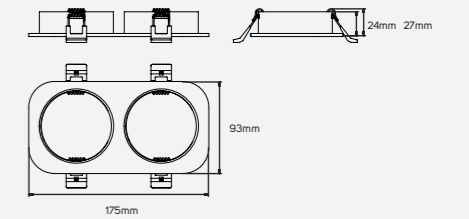

Reflector

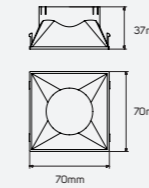
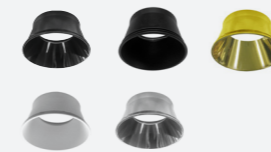

- 5101724
- 5101725
- 5101726
- 5101727
- 5101728
- Aluminum

Family Product List

Code No.	Model No.	Mounting Dimensions
● 5101722	ILS093FRFCRW01	150x75mm
● 5101723	ILS093FRFCRB01	150x75mm

Frame

Pioneer R

Technical Operating & Electrical Data

Body Material	Aluminum + PC front lock
Cap Type	GU10&Mr16 & GUPO Module
Fixed or Adjustable	Adjustable

Areas of Application

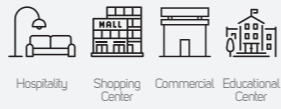

Dimensions

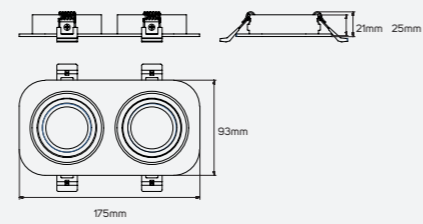

Reflector

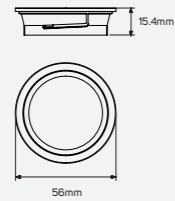

- 5101731
- 5101732
- 5101733
- 5101734
- 5101735
- Aluminum + PC front lock

Family Product List

Code No.	Model No.	Mounting Dimensions
● 5101729	ILS093FRCFRW02	150x75mm
● 5101730	ILS093FRCFRB02	150x75mm

Frame

Pioneer R

Technical Operating & Electrical Data

Body Material	Aluminum
Cap Type	GU10&Mr16 & GUPO Module
Fixed or Adjustable	Fixed

Areas of Application

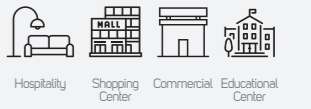

Dimensions

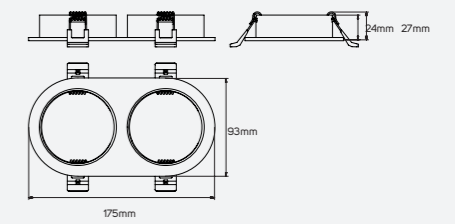

Reflector

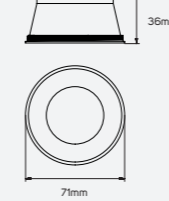

- 5101738
- 5101739
- 5101740
- 5101741
- 5101742
- Aluminum

Family Product List

Code No.	Model No.	Mounting Dimensions
● 5101736	ILS093FRCFRW03	150x75mm
● 5101737	ILS093FRCFRB03	150x75mm

Frame

Pioneer R

Technical Operating & Electrical Data

Body Material	Aluminum + PC front lock
Cap Type	GU10&Mr16 & GUPO Module
Fixed or Adjustable	Adjustable

Areas of Application

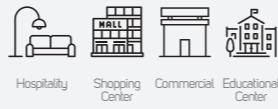

Dimensions

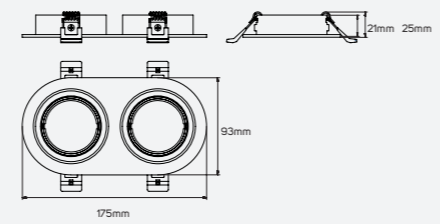

Reflector

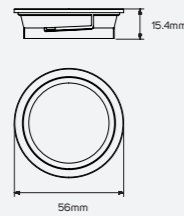

- 5101745
- 5101746
- 5101747
- 5101748
- 5101749
- Aluminum + PC front lock

Family Product List

Code No.	Model No.	Mounting Dimensions
● 5101743	ILS093FRCFRW04	150x75mm
● 5101744	ILS093FRCFRB04	150x75mm

Frame

Pioneer S

Technical Operating & Electrical Data

Body Material	Aluminum
Cap Type	AR111
Fixed or Adjustable	Adjustable

Areas of Application

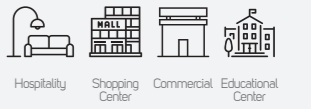

Dimensions

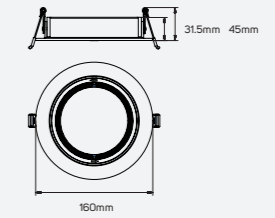

Family Product List

Code No.	Model No.	Mounting Dimensions
● 5101750	ILS160ASCFMR11ORW01	Ø150mm
● 5101751	ILS160ASCFMR11ORB01	Ø150mm

Frame

Pioneer S

Technical Operating & Electrical Data

Body Material	Aluminum
Cap Type	AR11
Fixed or Adjustable	Adjustable

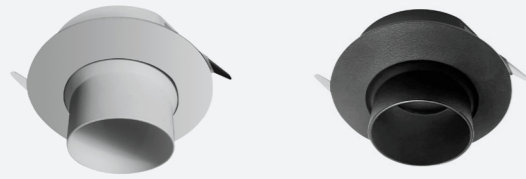

Dimensions

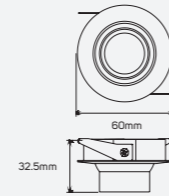

Areas of Application

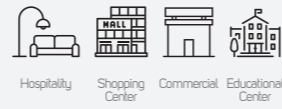

Frame

Pioneer S

Technical Operating & Electrical Data

Body Material	Aluminum
Fixed or Adjustable	Non Directional



Dimensions

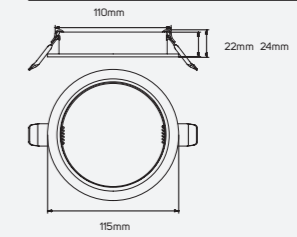

Areas of Application

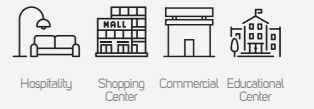

Reflector

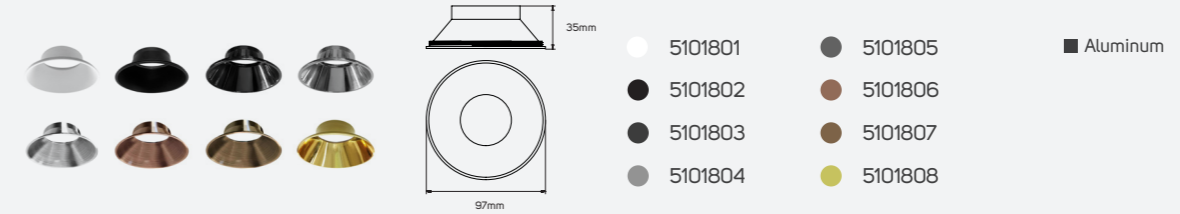

Family Product List

Code No.	Model No.	Mounting Dimensions
5101793	ILSAMR11FW01	Ø55mm
5101794	ILSAMR11FB01	Ø55mm

Family Product List

Code No.	Model No.	Mounting Dimensions
5101799	ILS113FRFCW01	Ø100mm
5101800	ILS113FRFCB01	Ø100mm

Frame

Pioneer S

Technical Operating & Electrical Data

Body Material	Aluminum
Cap Type	GU10
Fixed or Adjustable	Fixed



Dimensions

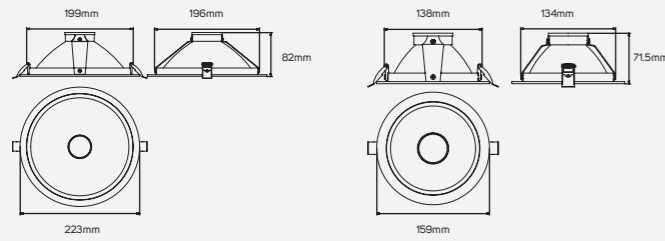

Family Product List

Code No.	Model No.	Mounting Dimensions
5101809	ILS140REFRFW01	Ø140mm
5101810	ILS140REFRFB01	Ø140mm
5101811	ILS200REFRFW01	Ø200mm
5101812	ILS200REFRFB01	Ø200mm

Areas of Application

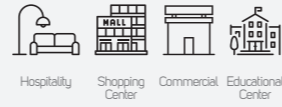

Frame

Pioneer T

Technical Operating & Electrical Data

Body Material	Aluminum+Metal
Holder Type	G9
Fixed or Adjustable	Adjustable

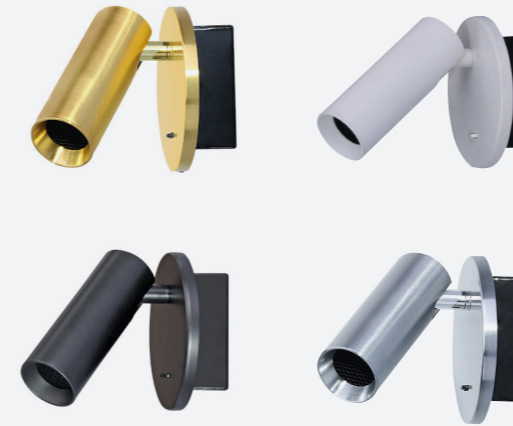

Areas of Application

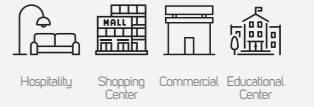

Dimensions

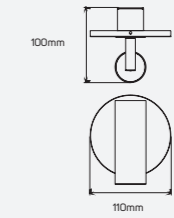

Family Product List

Code No.	Model No.	Mounting Dimensions
5101795	ILTMEFSWL40	40*85
5101796	ILTMEFSWL40	40*85
5101797	ILTMEFSWL40	40*85
5101798	ILTMEFSWL40	40*85



Gypsum Frame

Gypsum Frame

Cloudsoft Glow

Areas of Application

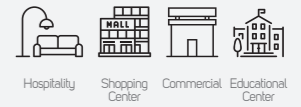

Technical Operating & Electrical Data

Input Voltage & Frequency	AC220-240V, 50/60Hz
Body Material	Gypsum
IP Rating	IP20

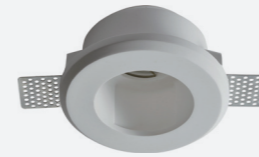

Dimensions

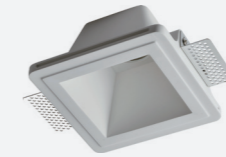
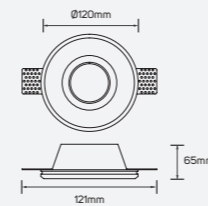

Dimensions

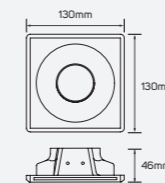

Dimensions

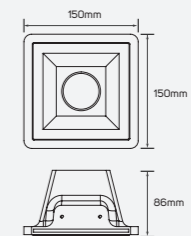

Dimensions

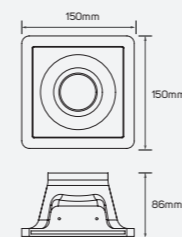

Dimensions

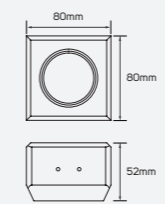

Dimensions

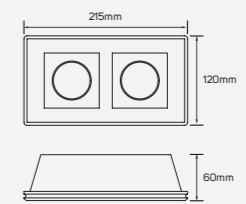

Family Product List

Code No.	Model No.	Cutting Size
631080	ILS120SFW02	Ø125mm
631081	ILS130SFW01	135x135mm
631083	ILS120SFW04	155x155mm
631084	ILS150SFW01	155x155mm
631085	ILS215SFW01	125x220mm
631089	ILS080SFW01	85x85mm

Gypsum Frame

Cloudsoft Glow

Areas of Application

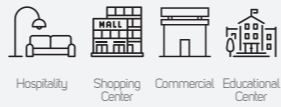

Technical Operating & Electrical Data

Input Voltage & Frequency	AC220-240V, 50/60Hz
Body Material	Gypsum
IP Rating	IP20



Dimensions

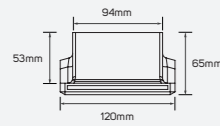

631082



Dimensions

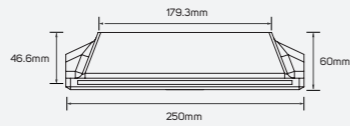

631086



Dimensions

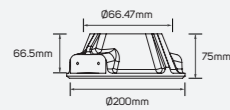

631087



Dimensions

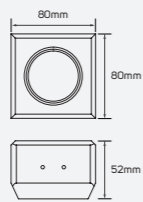

631090



Dimensions

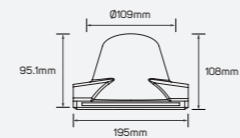

631091

Family Product List

Code No.	Model No.	Cutting Size
631082	ILS120SF03	125x125mm
631086	ILS250SF01	155x255mm
631087	ILS200SF01	Ø205mm
631090	ILS080SF02	85x85mm
631091	ILS195SF01	170x200mm



Accessories

- Indoor Connector
- Emergency Back Up Battery

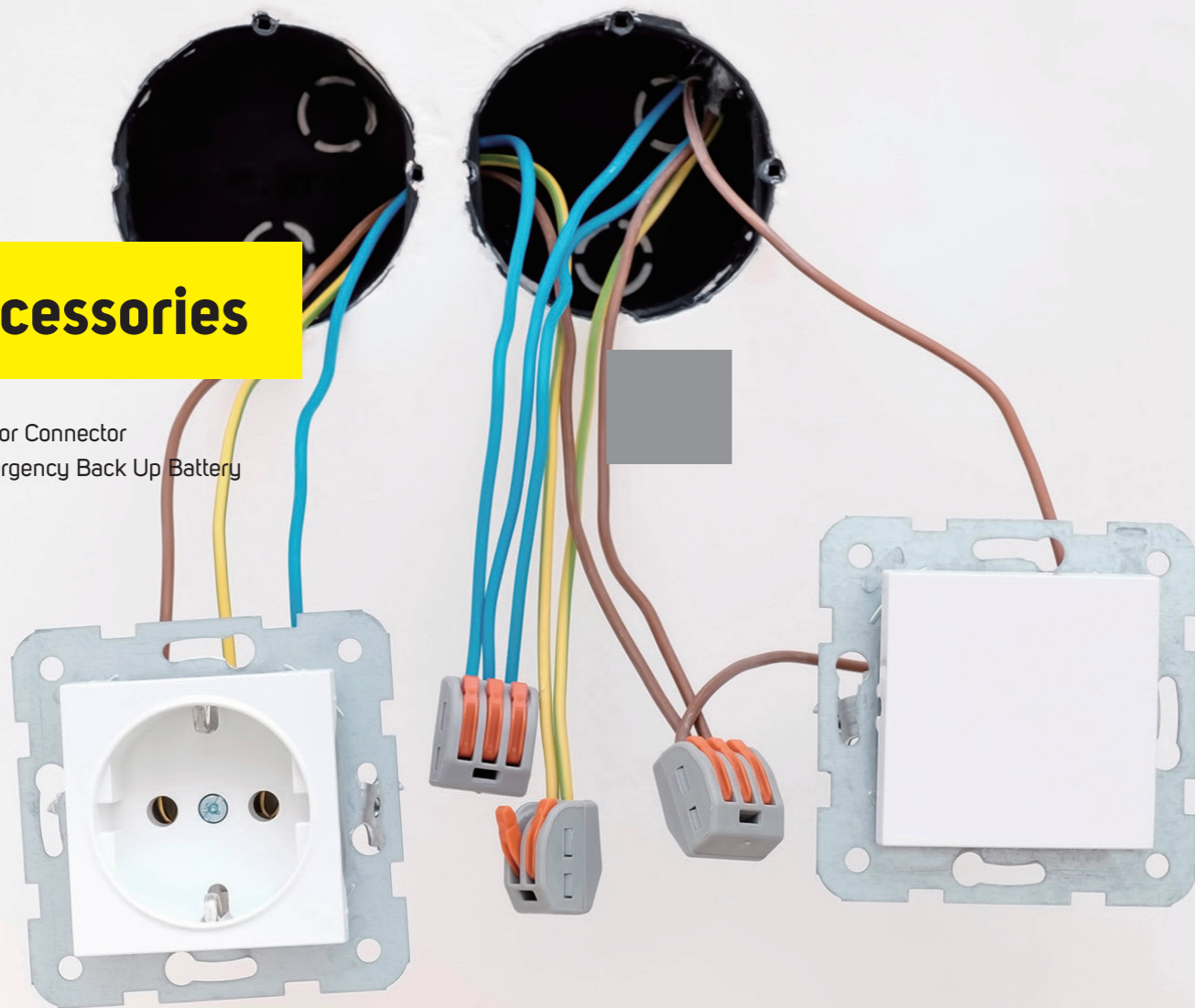

Indoor Connector

Power

Technical Operating & Electrical Data

Input Voltage & Frequency

AC100-240V, 50/60Hz

Body Color

Orange + Grey

Areas of Application

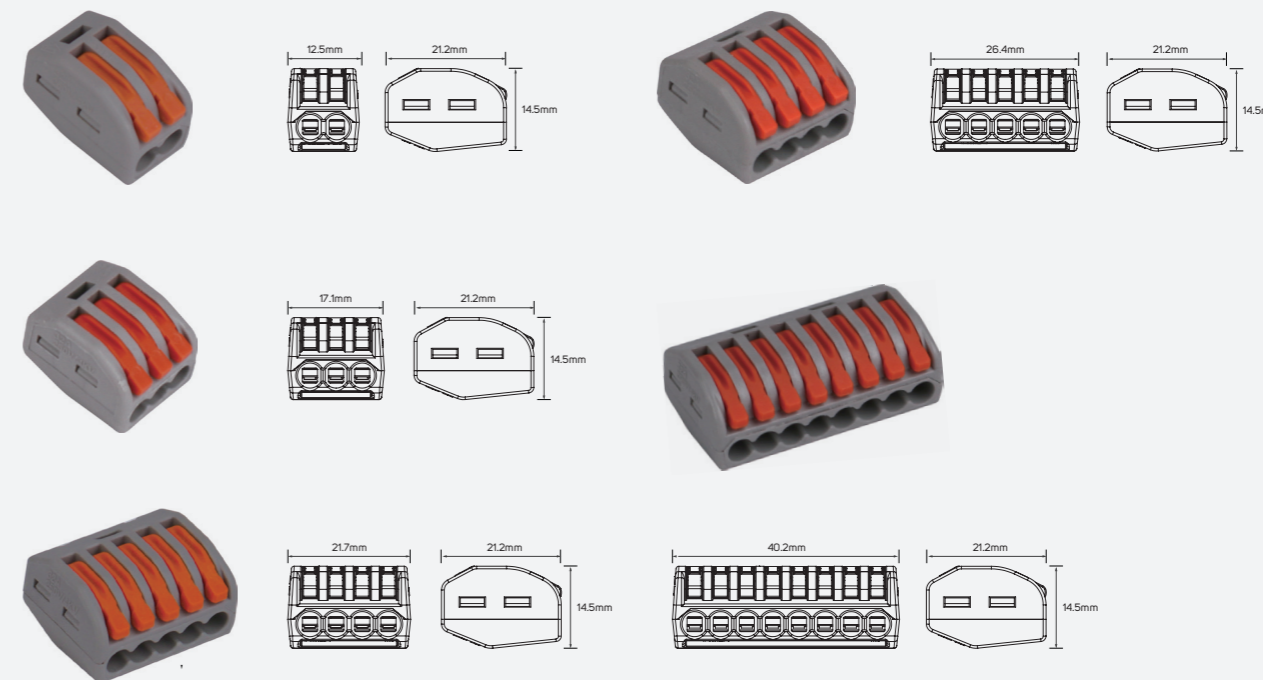
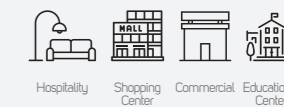

- 613174
- 613175
- 613176

- 613177
- 613178

- Nylon
- AC100-240V

Power

Technical Operating & Electrical Data

Input Voltage & Frequency

AC100-240V, 50/60Hz

Body Color

Orange+ Grey

Areas of Application

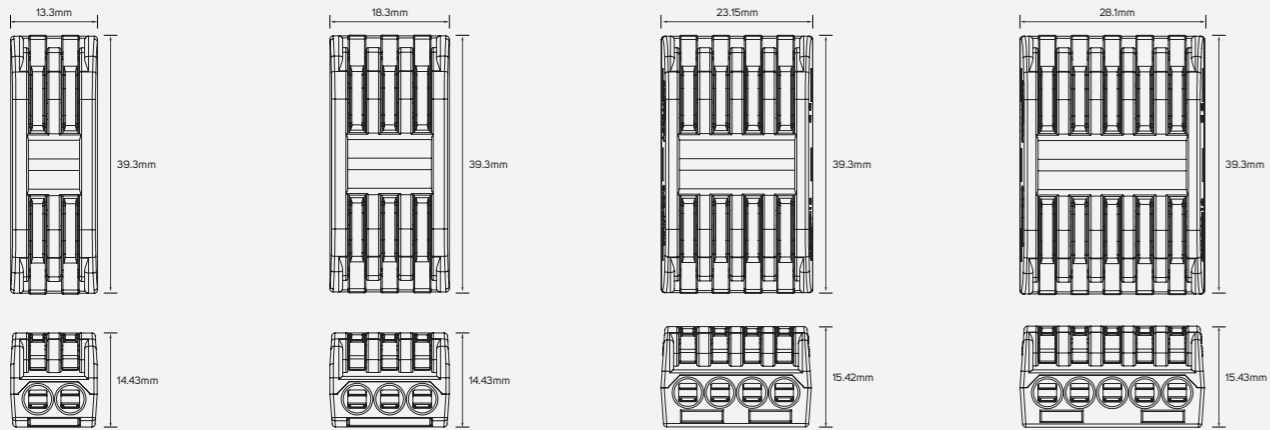
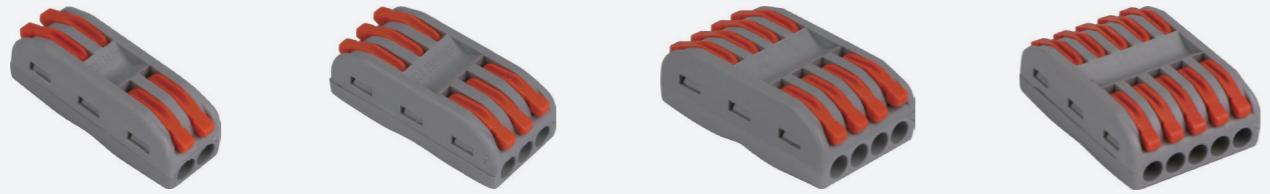
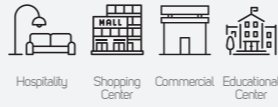

- 613179 613181
- 613180 613182

■ Nylon
⏏ AC100-240V

Power

Technical Operating & Electrical Data

Input Voltage & Frequency

AC100-240V, 50/60Hz

Body Color

Red, Blue, Yellow

Areas of Application

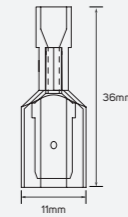
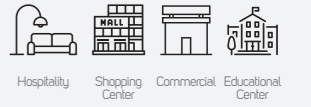

- 613168
- 613169
- 613170

■ Nylon+Copper
⏏ AC100-240V

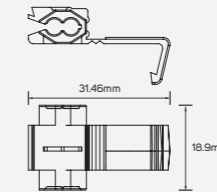
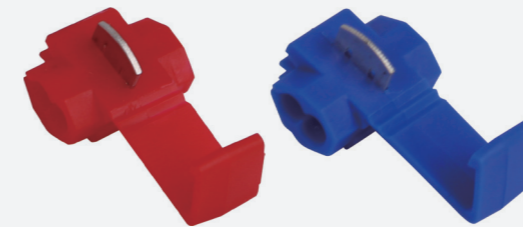

- 613171 613173
- 613172

■ Nylon+Copper
⏏ AC100-240V

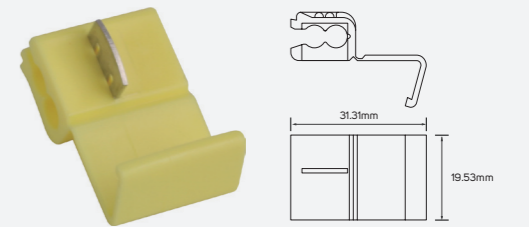

Indoor Connector

Power

Technical Operating & Electrical Data

Input Voltage & Frequency AC100-240V, 50/60Hz

Body Color Blue+ Orange+Grey, Blue+ Yellow+ Orange+Grey, Blue+ Red+Grey, Blue+ Red+Yellow+ Orange+Grey

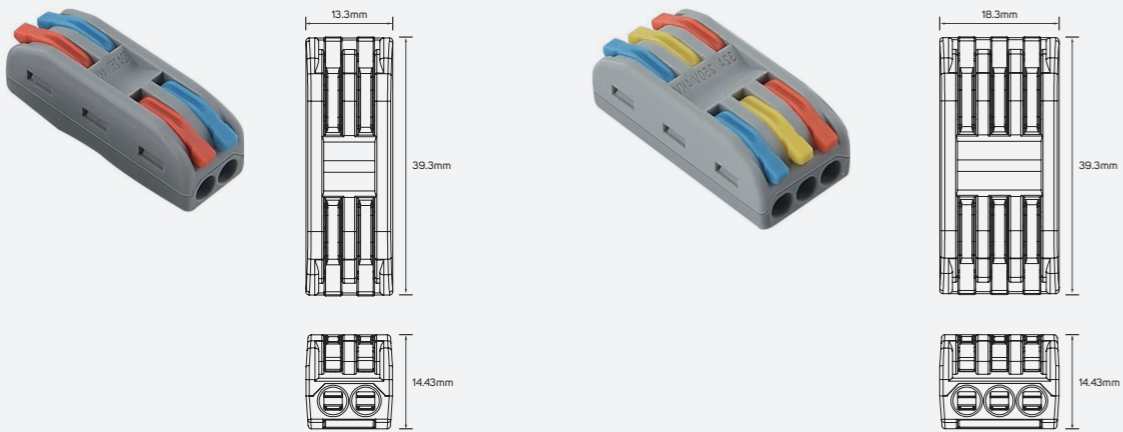

- 613625 ■ Nylon+Copper
- 613626 □ AC100-240V

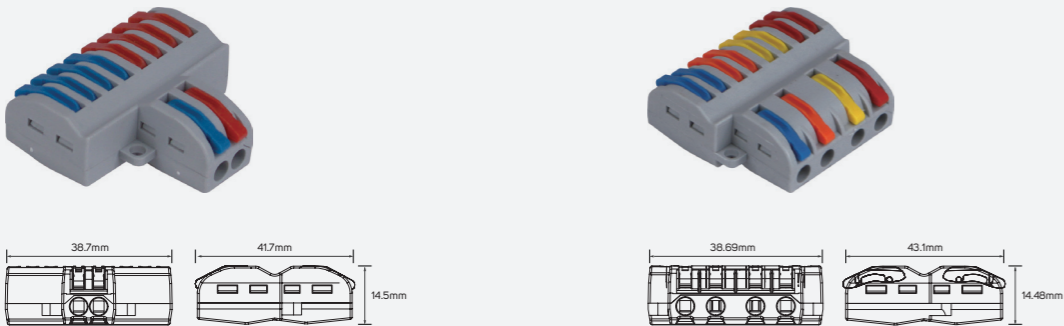

- 613187 ■ Nylon
- 613190 □ AC100-240V

Areas of Application

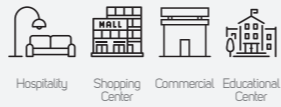

Indoor Connector

Power

Technical Operating & Electrical Data

Input Voltage & Frequency AC100-240V, 50/60Hz

Body Color Blue+ Red+ Grey, Blue+ Yellow+Red+ Grey

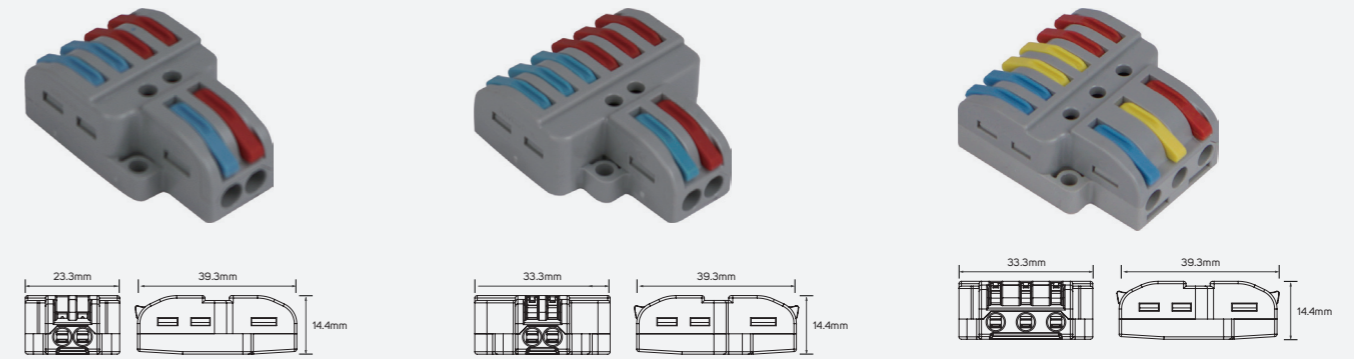

- 613185 ■ PC
- 613186 □ AC100-240V
- 613188 ■ PC
- 613189 □ AC100-240V

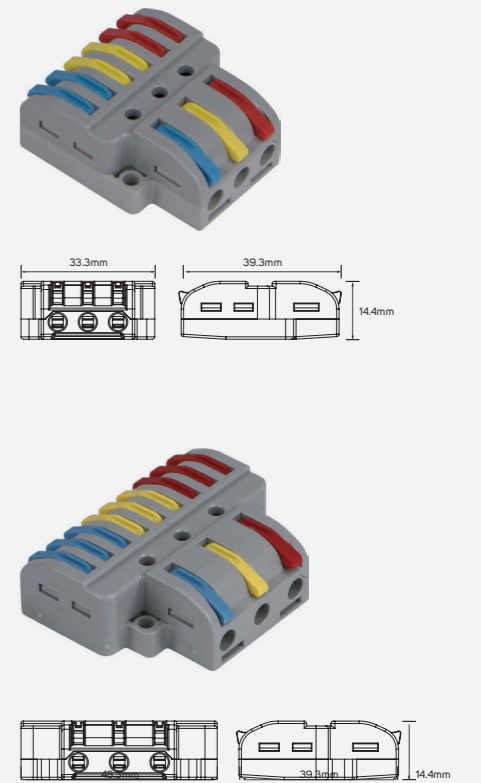

Areas of Application

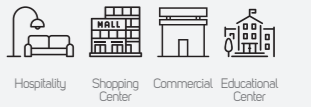

Power

Technical Operating & Electrical Data

Input Voltage & Frequency AC100-240V, 50/60Hz
 Body Color White, White, Transparent + Blue, Green+Transparent

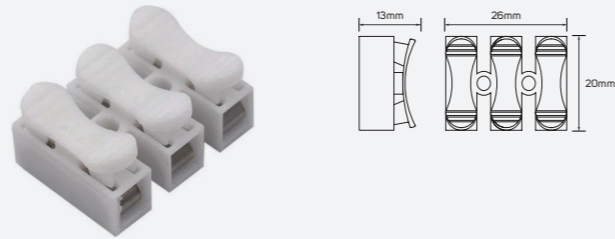
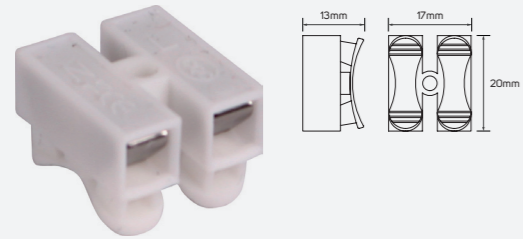

- 613183
- 613627
- Polypropylene
- ⏏ AC100-240V

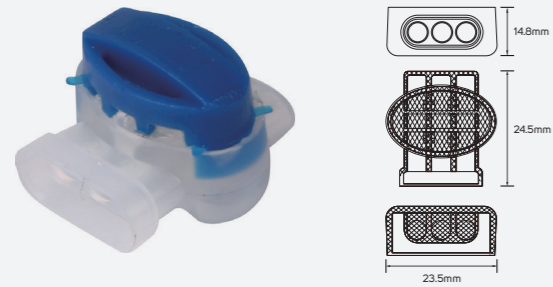

- 613184
- 613628
- Nylon
- Nylon+Copper
- ⏏ AC100-240V
- ⏏ AC100-240V

Emergency

Technical Operating & Electrical Data

Input Voltage & Frequency AC220-240V, 50/60Hz
 Warranty Period 36 Months

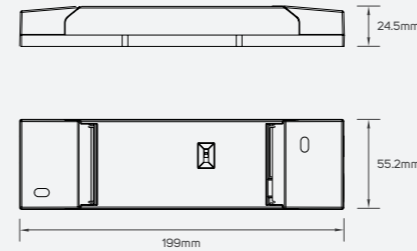
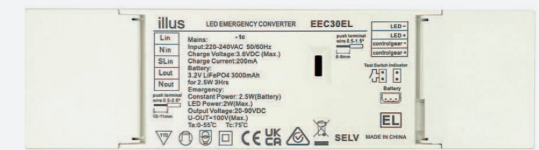
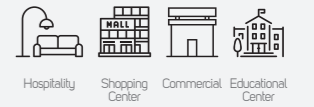

615349

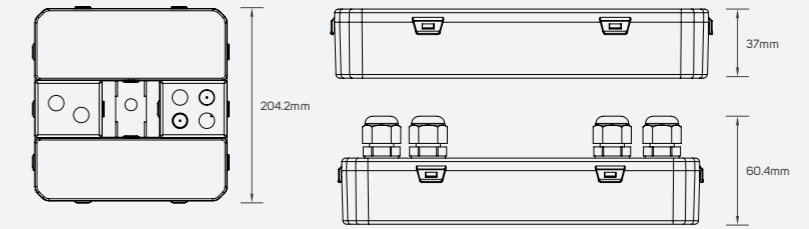

615350

- 615349 White PC IP20
- 615350 Black PC IP65

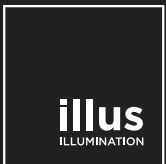

Contact Us

global@illuslighting.com

www.illuslighting.com

Find us in KSA, UAE, Oman, Kuwait, Qatar, Egypt, Spain, Bahrain, China.