

Project Range

2026 Catalogue

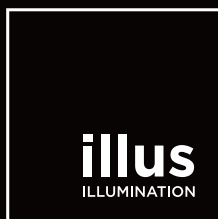

BEYOND LIGHT..
TO THE LAST DETAILS!

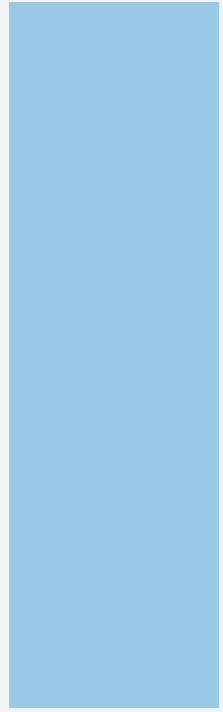
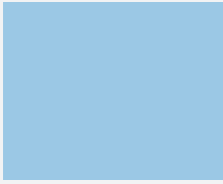

We strive to be
the leader in the industry
and the world's most
respected lighting solution
provider.

ILLUS Lighting

ILLUS dedicates itself to provide human oriented architectural lighting solution and products for indoor and outdoor applications. A truly innovative company, ILLUS has always been at the forefront of professional office lighting since inception. Since then ILLUS continues developing innovative, custom lighting solutions that meet extremely exacting requirements in terms of ergonomics, economic efficiency and environmental compatibility and also deliver aesthetic added value to our customers. Our customers will always find that our solutions reflect the requirements satisfying a broad range of customer needs for every lighting application ILLUS is a brand that helps revealing the beauty around you where it constitutes of products and solutions designed with care and attention to detail giving professional quality products.

Our goal has always been to offer our customers a first-class product backed by unparalleled service, focused on solving our client's illumination challenges.

Our Vision

In ILLUS every detail created with enthusiasm constantly evolving technology to simplify the life of people. We consistently innovate and devote to decrease power consumption to ease the burden of earth. Light is essential for people's life quality and well-being, we care for every situation people need artificial light whenever light serves. ILLUS lighting is beyond light, to the last details.

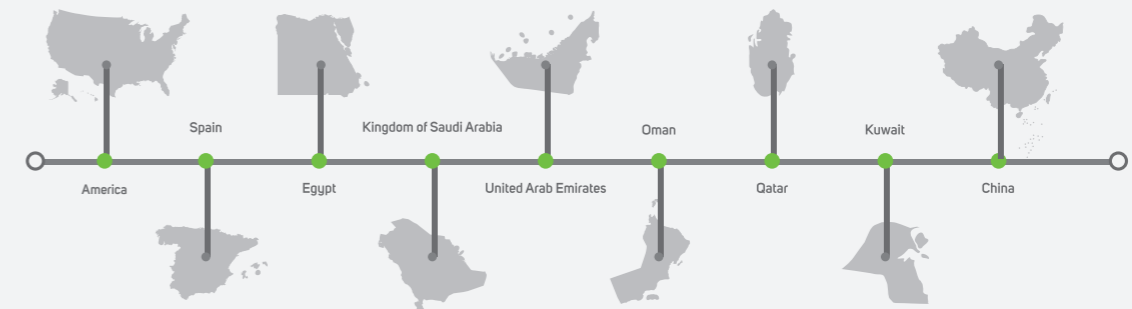

Where to find us

Kingdom of Saudi Arabia-Head Office

📍 3533 Al Kharj Rd, Al Aziziyah, Riyadh 14511
<https://maps.app.goo.gl/TRgDmL4efaDRzWWL8>

China – illus

📍 Star Alliance, No.68 Zhongxing Avenue, Guzhen, Zhongshan,Guangdong, China
<https://maps.app.goo.gl/cJJefWvYRyfzAQjq8>

Spain – illus

📍 46970 Alaquàs, Valencia, Spain
<https://goo.gl/maps/C5DejH52sP17L2Nv9>

UAE – Build Station

📍 75 6th St - Al Quoz - Dubai - United Arab Emirates
<https://goo.gl/maps/LCTSSYSqEB2mcAbA8>

Kingdom of Bahrain

📍 7J3Q+R36, Arad, Bahrain
<https://maps.app.goo.gl/e2wceYwDusnepts7>

Qatar – Build Station

📍 Zone 43, Street 340, Salwa Rd, Doha, Qatar
<https://maps.app.goo.gl/hQY8PbFDPbXKYiqJ6>

Oman – Build Station

📍 18 November Street 411 Muscat, Al Aziba, 130, Oman
<https://goo.gl/maps/6tJLBVdhiVPvUE1w7>

Kuwait –Lighting Stores

📍 No 4, Opposite the city center entrance, 142 8 St, Shuwaikh Industrial, Kuwait
Lighting Stores - Google Maps

Egypt -illus

📍 13 El Obour Bldgs. Salah Salem – Masr El-Gedida - Cairo
30° 04'40.0"N 31° 18'36.7"E - Google Maps



R&D and Manufacturing

Manufacturing

ILLUS has two directly-operated production bases in Yangzhou covering an area of 25,000 square meters and 300 staffs. The production bases contain over 30 hi-speed automatic encapsulation lines, 15 automatic SMD and applied welding lines, 5 automatic extrusion lines and 6 automatic luminaire production lines, characterizing a complete production process for LED strip inclusive of LED encapsulation, hi-speed SMT, automatic welding and full series of water resistance with average monthly production capacity of LED strips reaching up to 1.5 million meters. Besides, ILLUS modernized manufacturing factory to achieve a complete production process for linear luminaire inclusive of precision machining, automatic assembly, color spraying and free customization with average monthly production capacity reaching up to 120,000 strips in order to assure customers of high-quality, super cost-effective products and rapid delivery.



R&D

ILLUS has established a R&D expert team composed of over 50 core technicians, a majority of which graduated from top-rated universities and are proficient in such fields as optics, technique, material science, electrics, thermal physics, intelligent control and industrial design with more than 10years R&D experience and technical know-how in linear lighting.



Laboratory & Inspection

Laboratory of ILLUS, covering an area of 460 square meters, was outfitted with 48 sets of equipment which was distributed as per safety zone, EMC zone, photoelectric zone, IP water resistance zone, aging zone and product reliability zone. Inspection covers products inclusive of LED strip, neon strip, linear luminaire, power supply and related accessories, with inspection standard ranging from safety, EMC, performance to product reliability. Testing reports can be tracked all the way from product design evaluation period to type approval period to guarantee quality of products.



Patent

ILLUS strives to R&D in product and technology. So far, it has gained 3 invention patents and nearly 100 utility model patents and appearance patents.

Contents

Project Range

- LED Flood Light
- LED Solar Light
- LED High Bay Light
- Architectural & Decorative
- Indoor Project Lighting



Project Range

- LED Flood Light
- LED Solar Light
- LED High Bay Light
- Architectural & Decorative
- Indoor Project Lighting



LED Flood Light



LED Flood Luminaire

Stander

Areas of Application

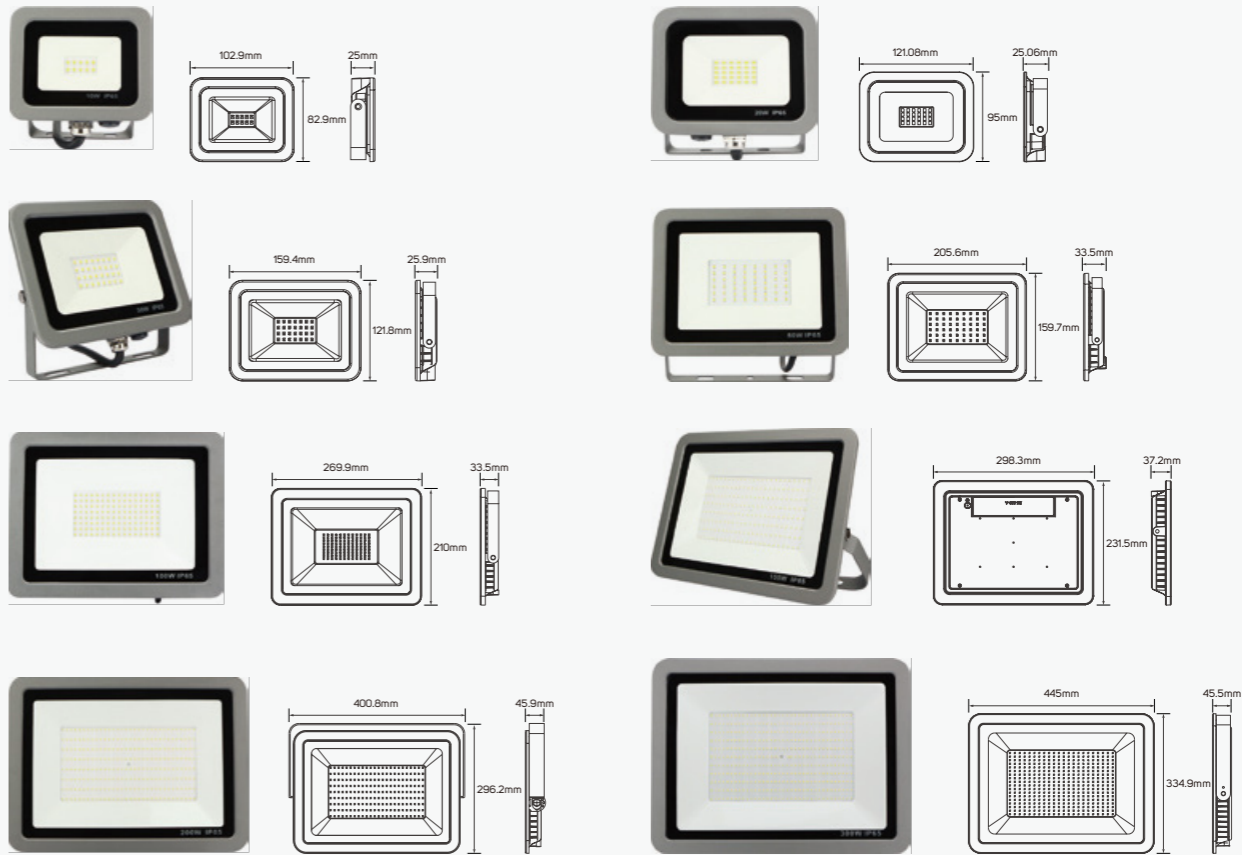

Family Product List

Code No.	Power	CCT	Lumen
● 611637	10W	3000K	800lm
● 611638	10W	4000K	800lm
● 611639	10W	5700K	800lm
● 611640	20W	3000K	1600lm
● 611641	20W	4000K	1600lm
● 611642	20W	5700K	1600lm
● 611643	30W	3000K	2400lm
● 611644	30W	4000K	2400lm
● 611645	30W	5700K	2400lm
● 611646	50W	3000K	4000lm

■ Aluminum

IP 65 CRI 80 120°

AC220-240V 35,000h

Champion

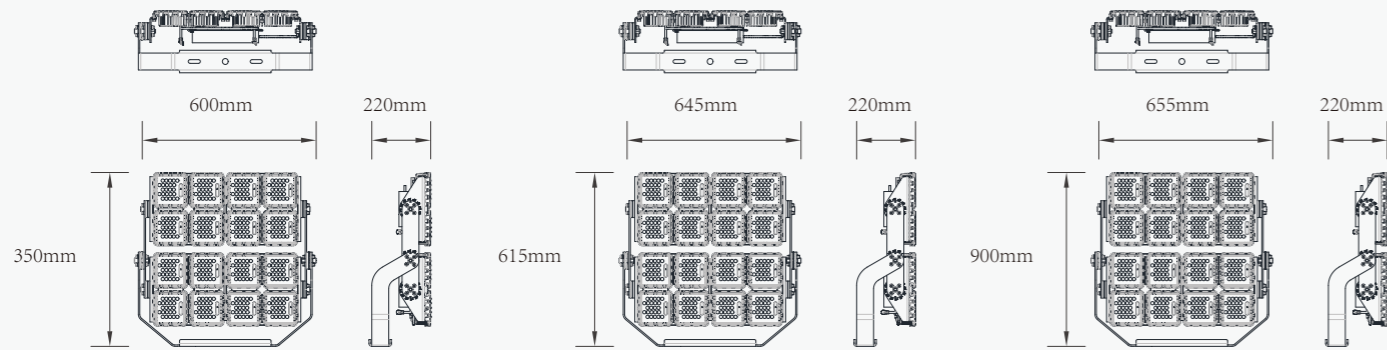

Family Product List(3535)

IP 67/68 □ 100 - 277VAC

Code No.	Power	Efficacy	Lumen	CCT	CRI
● LI40A-2	300W	135lm/W	40500lm	3000/4000/5000/5700K	70
	400W	130lm/W	52000lm	3000/4000/5000/5700K	70
	500W	125lm/W	62500lm	3000/4000/5000/5700K	70
	300W	124lm/W	37200lm	3000/4000/5000K	80
	400W	118lm/W	47200lm	3000/4000/5000K	80
	500W	115lm/W	57500lm	3000/4000/5000K	80
	300W	107lm/W	32100lm	3000/4000/5000K	90
	400W	103lm/W	41200lm	3000/4000/5000K	90
	500W	97lm/W	48500lm	3000/4000/5000K	90

Family Product List(3535)

IP 67/68 □ 100 - 277VAC

Code No.	Power	Efficacy	Lumen	CCT	CRI
● LI40A-4	600W	135lm/W	81000lm	3000/4000/5000/5700K	70
	800W	130lm/W	104000lm	3000/4000/5000/5700K	70
	1000W	125lm/W	125000lm	3000/4000/5000/5700K	70
	600W	124lm/W	74400lm	3000/4000/5000K	80
	800W	118lm/W	94400lm	3000/4000/5000K	80
	1000W	115lm/W	115000lm	3000/4000/5000K	80
	600W	107lm/W	64200lm	3000/4000/5000K	90
	800W	103lm/W	82400lm	3000/4000/5000K	90
	1000W	97lm/W	97000lm	3000/4000/5000K	90
○ LI40A-6	900W	135lm/W	121500lm	3000/4000/5000/5700K	70
	1200W	130lm/W	156000lm	3000/4000/5000/5700K	70
	1500W	125lm/W	187500lm	3000/4000/5000/5700K	70
	900W	124lm/W	111600lm	3000/4000/5000K	80
	1200W	118lm/W	141600lm	3000/4000/5000K	80
	1500W	115lm/W	172500lm	3000/4000/5000K	80
	900W	107lm/W	96300lm	3000/4000/5000K	90
	1200W	103lm/W	123600lm	3000/4000/5000K	90
	1500W	97lm/W	145500lm	3000/4000/5000K	90

Family Product List(5050)

IP 67/68 □ 100 - 277VAC

Code No.	Power	Efficacy	Lumen	CCT	CRI
● LI40A-2	300W	164lm/W	49200lm	3000/4000/5000/5700K	70
	400W	157lm/W	62800lm	3000/4000/5000/5700K	70
	500W	150lm/W	75000lm	3000/4000/5000/5700K	70
	300W	147lm/W	44100lm	3000/4000/5000K	80
	400W	141lm/W	56400lm	3000/4000/5000K	80
	500W	135lm/W	67500lm	3000/4000/5000K	80
	300W	132lm/W	39600lm	3000/4000/5000K	90
	400W	127lm/W	50800lm	3000/4000/5000K	90
	500W	121lm/W	60500lm	3000/4000/5000K	90

Family Product List(5050)

IP 67/68

100 - 277VAC

Code No.	Power	Efficacy	Lumen	CCT	CRI
● LI40A-4	600W	164lm/W	98400lm	3000/4000/5000/5700K	70
	800W	157lm/W	125600lm	3000/4000/5000/5700K	70
	1000W	150lm/W	150000lm	3000/4000/5000/5700K	70
	600W	147lm/W	88200lm	3000/4000/5000K	80
	800W	141lm/W	112800lm	3000/4000/5000K	80
	1000W	135lm/W	135000lm	3000/4000/5000K	80
	600W	132lm/W	79200lm	3000/4000/5000K	90
	800W	127lm/W	101600lm	3000/4000/5000K	90
	1000W	121lm/W	121000lm	3000/4000/5000K	90
● LI40A-6	900W	164lm/W	147600lm	3000/4000/5000/5700K	70
	1200W	157lm/W	188400lm	3000/4000/5000/5700K	70
	1500W	150lm/W	225000lm	3000/4000/5000/5700K	70
	900W	147lm/W	132300lm	3000/4000/5000K	80
	1200W	141lm/W	169200lm	3000/4000/5000K	80
	1500W	135lm/W	202500lm	3000/4000/5000K	80
	900W	132lm/W	118800lm	3000/4000/5000K	90
	1200W	127lm/W	152400lm	3000/4000/5000K	90
	1500W	121lm/W	181500lm	3000/4000/5000K	90



Stably

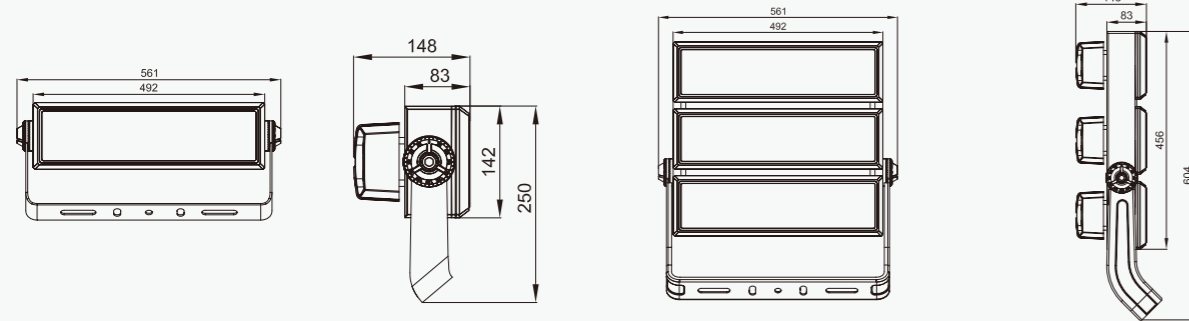

Family Product List

■ Aluminum+Lens IP 66 ⚡ AC100 ~ 277V

Code No.	Power	Efficacy	Lumen	CCT	CRI	Beam Angle
● LI-250W	250W	150lm/W	37500lm	4000K	80	10°/25°/45°/60°/90°/65°*25°
● LI-750W	750W	120lm/W	90000lm	4000K	80	10°/25°/45°/60°/90°/65°*25°



Flycloud

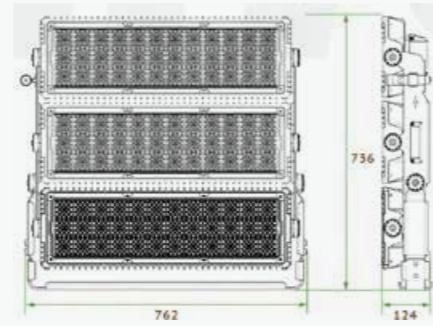
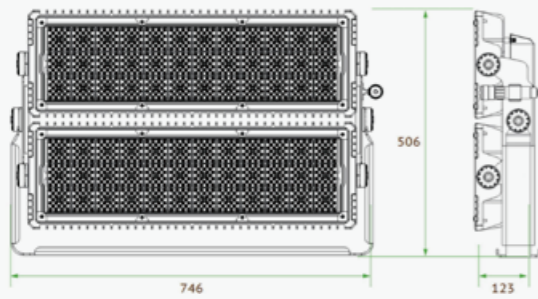

Family Product List

■ ADC12 Aluminum

IP 66

□ AC100 - 277V

Code No.	Power	Efficacy	Lumen	CCT	CRI	Beam Angle
● LI-1000W	1000W	170lm/W	170000lm	4000K	80	30°/45°/60°/90°
● LI-1500W	1500W	170lm/W	255000lm	4000K	80	30°/45°/60°/90°



Giant

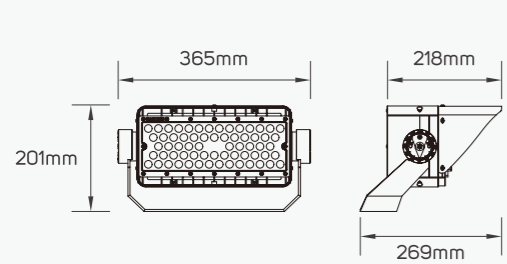

200W

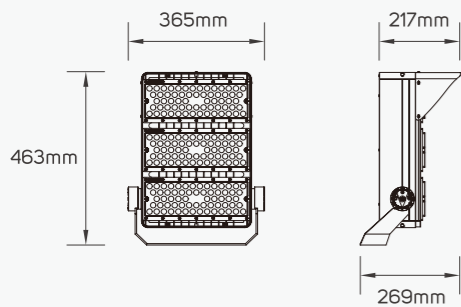

600W

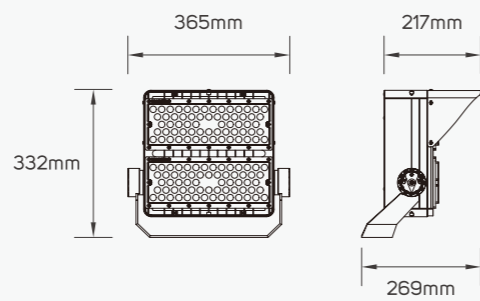

400W

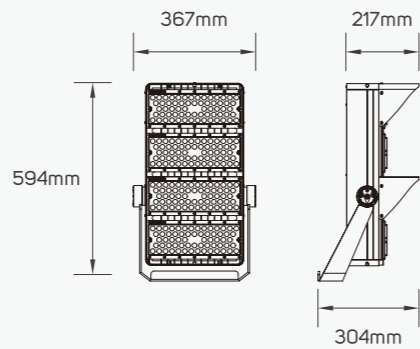

800W

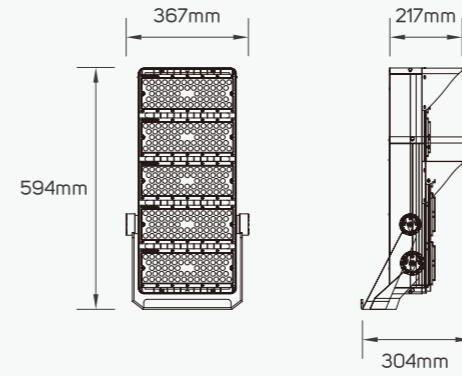

1000W

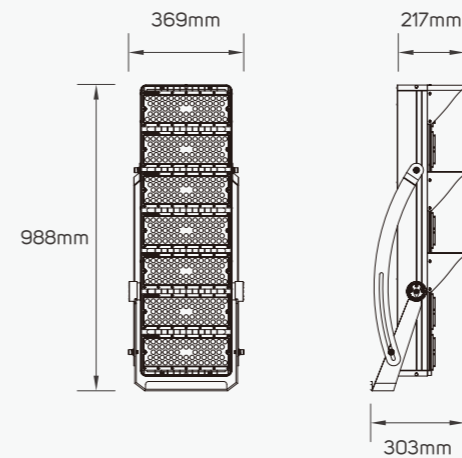

1200W

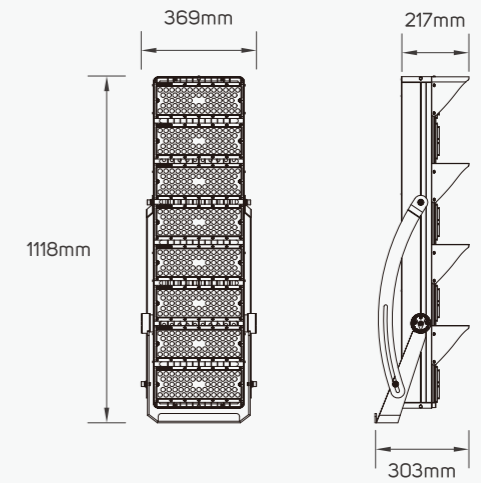

1600W

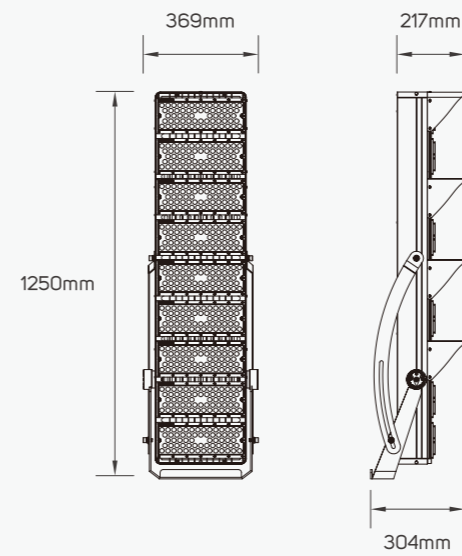

1800W

Family Product List

■ Aluminum and PC lens IP 65 CRI 70 AC100-277 V/347 V/480V 50,000h

Code No.	Power	Efficacy	Lumen	CCT	LED Quantity
● LI-HM200W-E	200W	148lm/W	29600lm	3000K-6500K	64pcs
● LI-HM400W-E	400W	148lm/W	60000lm	3000K-6500K	128pcs
● LI-HM600W-E	600W	148lm/W	90000lm	3000K-6500K	192pcs
● LI-HM800W-E	800W	150LM/W	120000lm	3000K-6500K	256pcs
● LI-HM1000W-E	1000W	150LM/W/	150000lm	3000K-6500K	320pcs
● LI-HM1200W-E	1200W	150LM/W	180000lm	3000K-6500K	384pcs
● LI-HM1400W-E	1400W	150LM/W	210000lm	3000K-6500K	448pcs
● LI-HM1600W-E	1600W	150LM/W	240000lm	3000K-6500K	512pcs
● LI-HM1800W-E	1800W	150LM/W	270000lm	3000K-6500K	576pcs

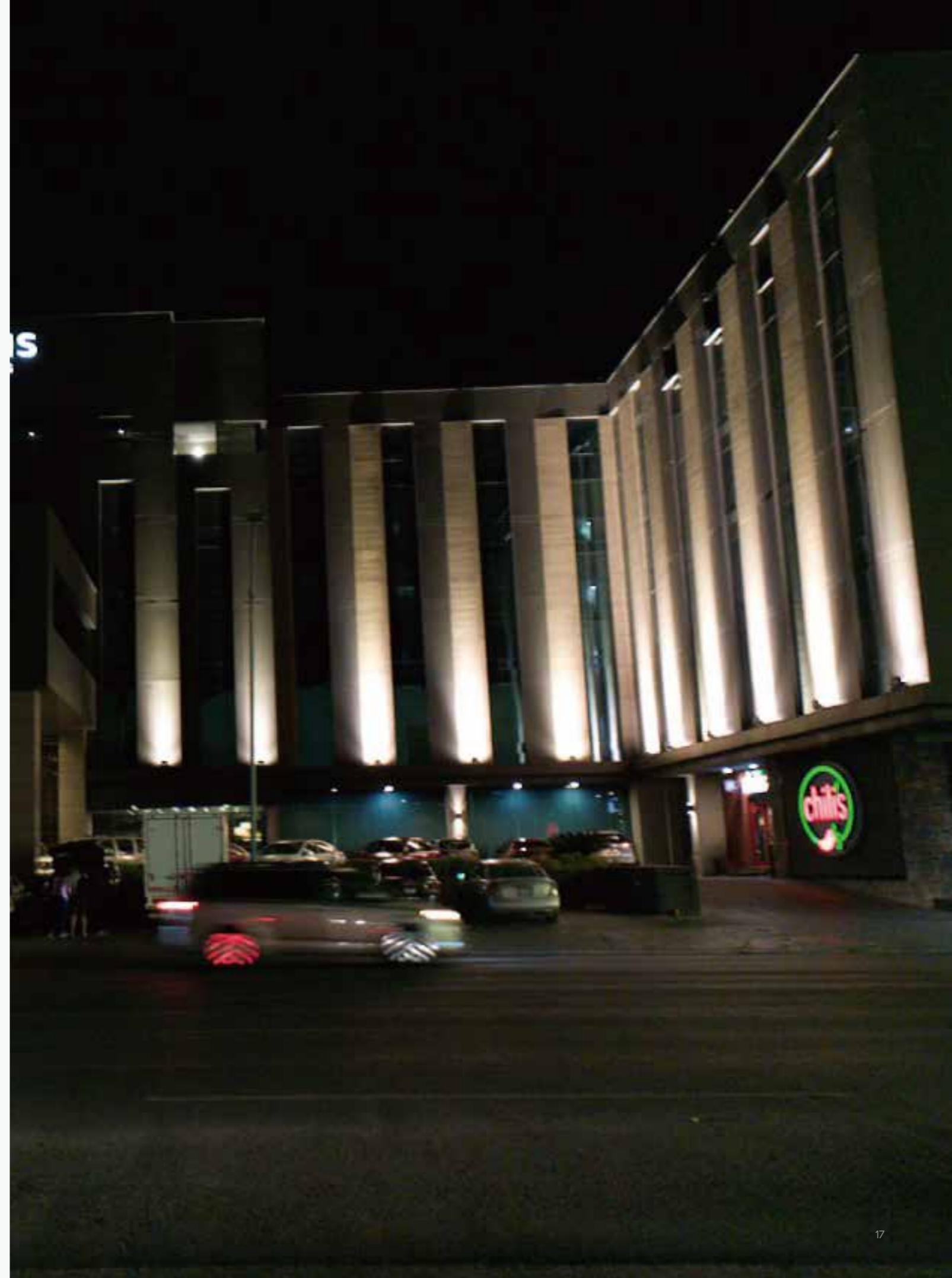

Giant

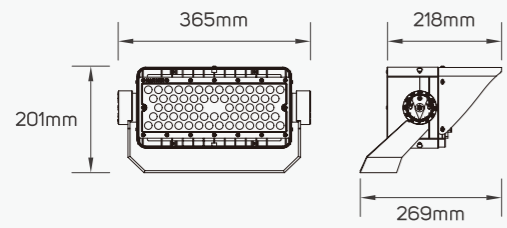

200W

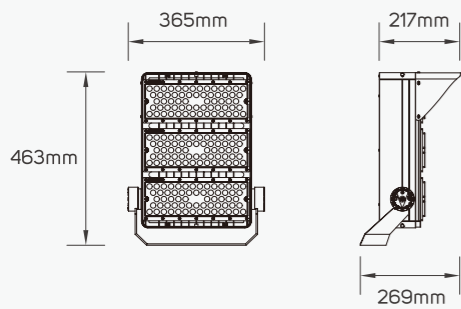

600W

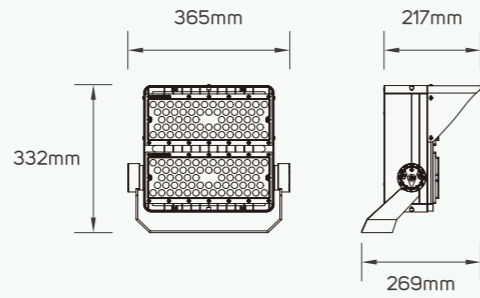

400W

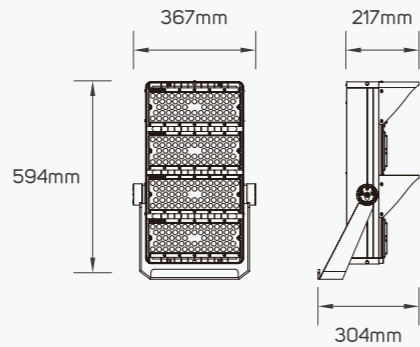

800W

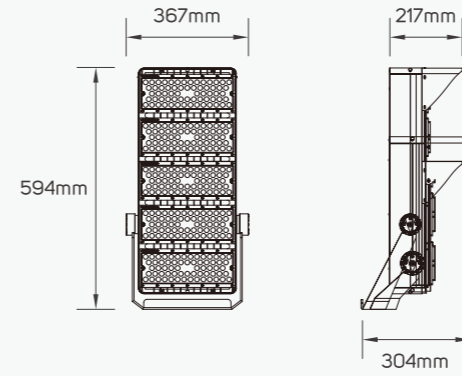

1000W

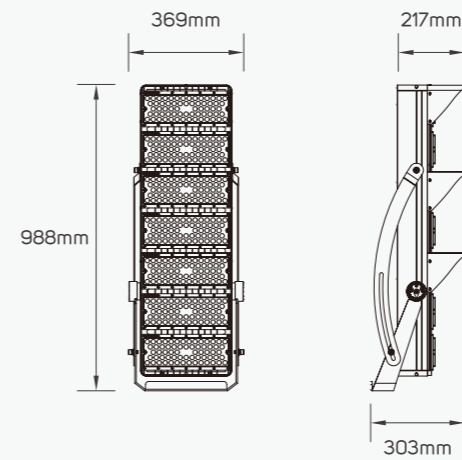

1400W

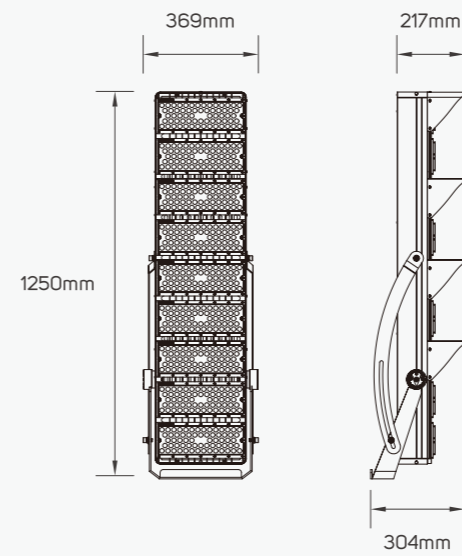

1800W

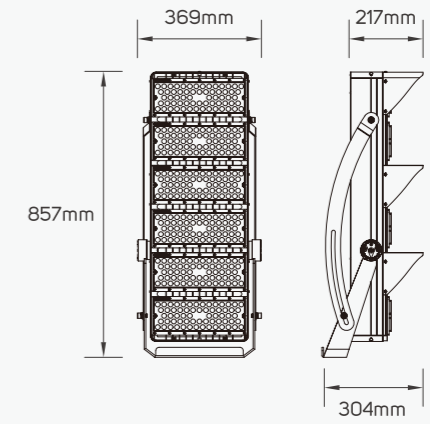

1200W

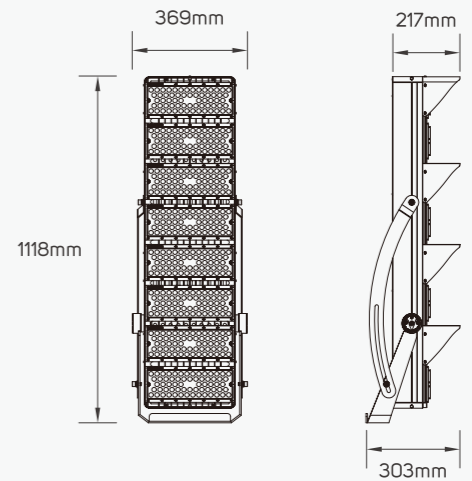

1600W

Family Product List

■ Aluminum and PC lens IP 65 CRI 70 AC100-277 V/347 V/480V 50,000h

Code No.	Power	Efficacy	Lumen	CCT	LED Quantity
LI-HM200W-E	200W	148lm/W	29600lm	3000K-6500K	64pcs
LI-HM400W-E	400W	148lm/W	60000lm	3000K-6500K	128pcs
LI-HM600W-E	600W	148lm/W	90000lm	3000K-6500K	192pcs
LI-HM800W-E	800W	150LM/W	120000lm	3000K-6500K	256pcs
LI-HM1000W-E	1000W	150LM/W	150000lm	3000K-6500K	320pcs
LI-HM1200W-E	1200W	150LM/W	180000lm	3000K-6500K	384pcs
LI-HM1400W-E	1400W	150LM/W	210000lm	3000K-6500K	448pcs
LI-HM1600W-E	1600W	150LM/W	240000lm	3000K-6500K	512pcs
LI-HM1800W-E	1800W	150LM/W	270000lm	3000K-6500K	576pcs



Robot

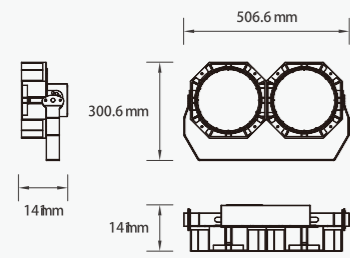
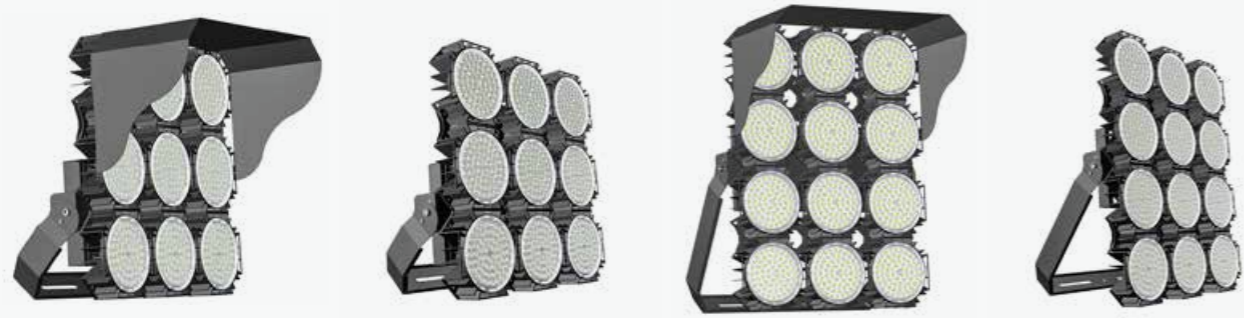

LI-HM240W-A

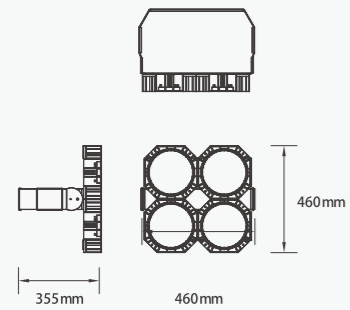

LI-HM480W-A

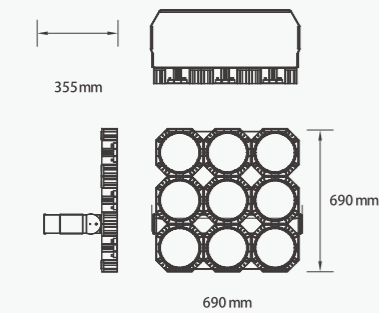

LI-HM960W-A

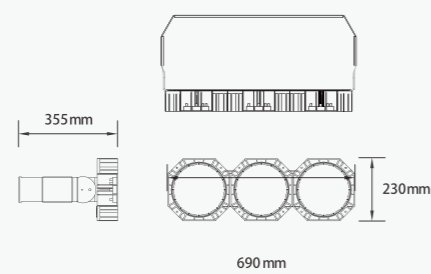

LI-HM320W-A

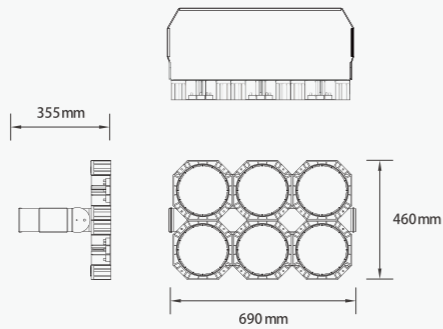

LI-HM720W-A

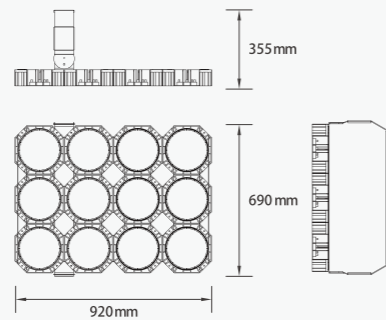

LI-HM1300W-A

Family Product List

■ Aluminum and PC lens IP 67 CRI 80 Lens 20°/30°/45° □ AC100-277 V/347 V/480V

Code No.	Power	Efficacy	Lumen	CCT	LED Quantity
● LI-HM240W-A	240W	160lm/W	38400lm	3000K/4000K/5000K/6000K	120pcs
● LI-HM320W-A	320W	160lm/W	51200lm	3000K/4000K/5000K/6000K	180pcs
● LI-HM480W-A	480W	160lm/W	76800lm	3000K/4000K/5000K/6000K	240pcs
● LI-HM720W-A	720W	160lm/W	115200lm	3000K/4000K/5000K/6000K	360pcs
● LI-HM960W-A	960W	160lm/W	153600lm	3000K/4000K/5000K/6000K	540pcs
● LI-HM1300W-A	1300W	160lm/W	208000lm	3000K/4000K/5000K/6000K	720pcs



LED Solar Light





LED Solar Post Top Light

Apollo



Family Product List

■ Die-cast Aluminum+PC

IP 65

Code No.	Power	Lumen	Solar Panel	Battery	Charging Time	Working Time
● SPB-SGL-Apollo-3	21W	2300Lm	33W/5V	LiFePO4, 3.2V/45AH	6-8H	12H(3-5 raining days)
● SPB-SGL-Apollo-6	30W	4000Lm	66W/5V	LiFePO4, 3.2V/80AH	6-8H	12H(3-5 raining days)



LED Solar Post Top Light

Bloom

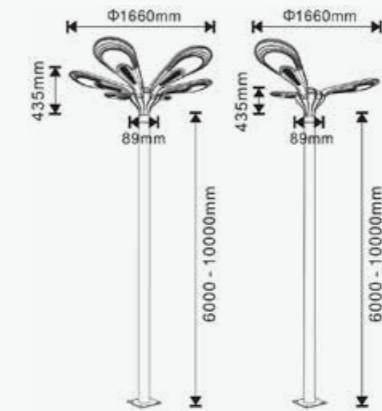

Family Product List

■ Die-cast Aluminum+PC

IP 65

Code No.	Power	Lumen	Solar Panel	Battery	Charging Time	Working Time
● ● SPB-SGL-Bloom-3	21W	2324Lm	48W/5V	LiFePO4, 3.2V/60AH	6-8H	12H(3-5 raining days)
● ● SPB-SGL-Bloom-6	30W	4648Lm	96W/5V	LiFePO4, 3.2V/120AH	6-8H	12H(3-5 raining days)



LED Solar Post Top Light

Chalice

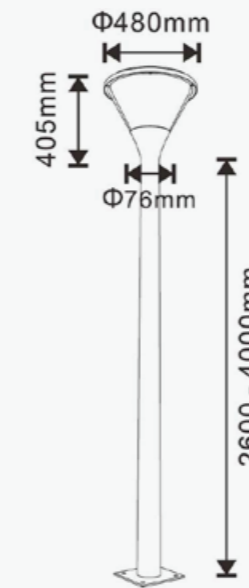

Family Product List

■ Die-cast Aluminum+PC

IP 65

Code No.	Power	Lumen	Solar Panel	Battery	Charging Time	Working Time
● SPB-SGL-Chalice	8W	1300Lm	20W/5V	LiFePO4, 3.2V/20AH	6-8H	12H(3-5 raining days)



LED Solar Post Top Light

Looker

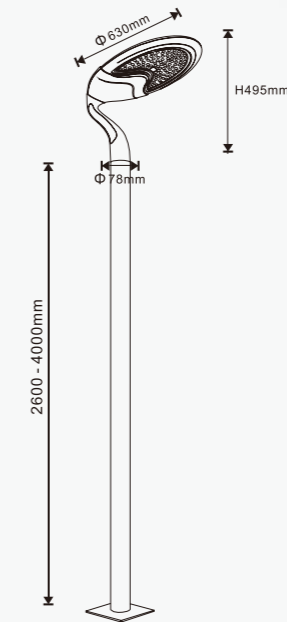

Family Product List

■ Die-cast Aluminum+PC

IP 65

Code No.	Power	Lumen	Solar Panel	Battery	Charging Time	Working Time
● SPB-SGL-Looker	15W	1500Lm	25W/5V	LiFePO4, 3.2V/36AH	6-8H	12H



LED Solar Post Top Light

Luna

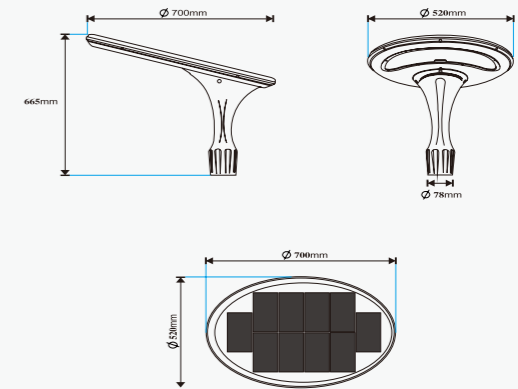

Family Product List

■ Die-cast Aluminum+PC

IP 65

Code No.	Power	Lumen	Solar Panel	Battery	Charging Time	Working Time
● SPB-SGL-Luna	20W	3300Lm	38W/5V	LiFePO4, 3.2V/60AH	6-8H	12H(3-5 raining days)



LED Solar Post Top Light

Moonlight

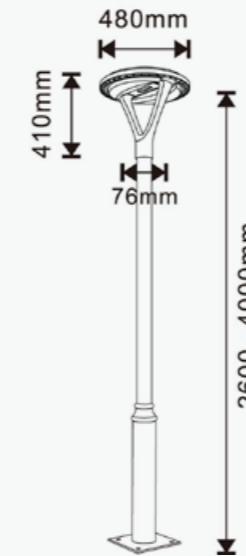

Family Product List

■ Die-cast Aluminum+PC

IP 65

Code No.	Power	Lumen	Solar Panel	Battery	Charging Time	Working Time
● SPB-SGL-Moonlight	8W	1050Lm	20W/5V	LiFePO4, 3.2V/20AH	6-8H	12H(3-5 raining days)



LED Solar Post Top Light

Trident

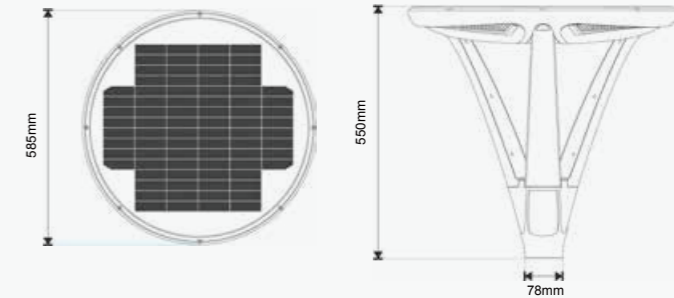

Family Product List

■ Die-cast Aluminum+PC

IP 65

Code No.	Power	Lumen	Solar Panel	Battery	Charging Time	Working Time
● SPB-SGL-Trident	16W	2700Lm	33W/5V	LiFePO4, 3.2V/45AH	6-8H	12H(3-5 raining days)



LED Solar Street Light Luminaire

Street Light



Family Product List

Code No.	Power	CCT	Lumen
613152	4.5W	3000K	1070lm
613153	4.5W	4000K	1090lm
613154	4.5W	6000K	1120lm
613155	6.5W	3000K	1570lm
613156	6.5W	4000K	1600lm
613157	6.5W	6000K	1640lm

■ Aluminum+Silicon

IP 65 CRI 80 100°
 AC220-240V 30,000h



Street Light



Family Product List

Code No.	Power	CCT	Lumen	Code No.	Power	CCT	Lumen
● 612839	50W	3000K	5400lm	● 612845	145W	3000K	15600lm
● 612840	50W	4000K	5450lm	● 612846	145W	4000K	15750lm
● 612841	50W	6000K	5550lm	● 612847	145W	6000K	15950lm
● 612842	100W	3000K	9700lm	● 612848	200W	3000K	20200lm
● 612843	100W	4000K	9800lm	● 612849	200W	4000K	22200lm
● 612844	100W	6000K	9950lm	● 612850	200W	6000K	22450lm

■ Aluminum+Silicon

IP 66 CRI 80 100°
AC100-277V 50,000h

Plug

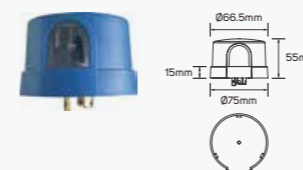

● 612851

■ Aluminum+Plastic

Explorer

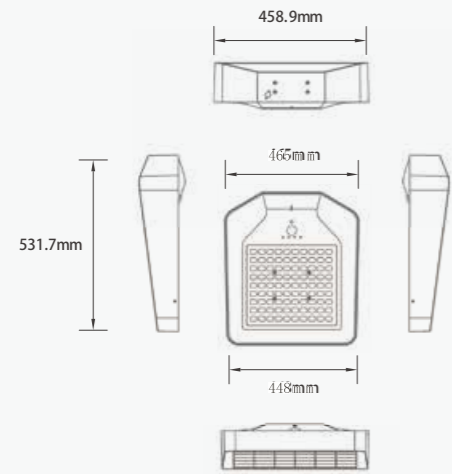

Family Product List

IP 66 Lighting Area 150m² 16.2V

Code No.	Power	Lumen	CCT	LED Quantity
● ILL-02	30W	5000lm	3000K(90pcs)+5700K(90pcs)	180pcs

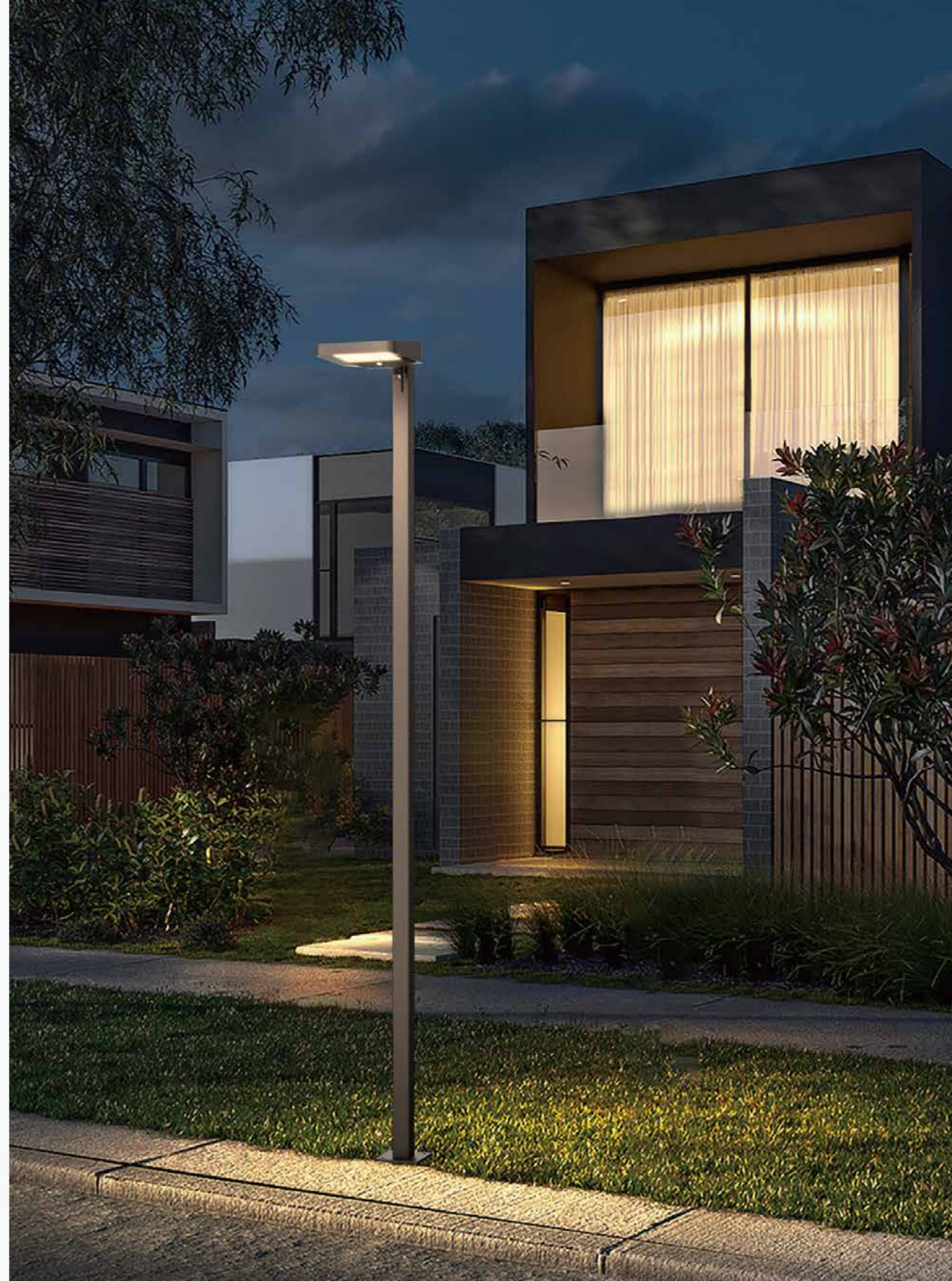

Chaser

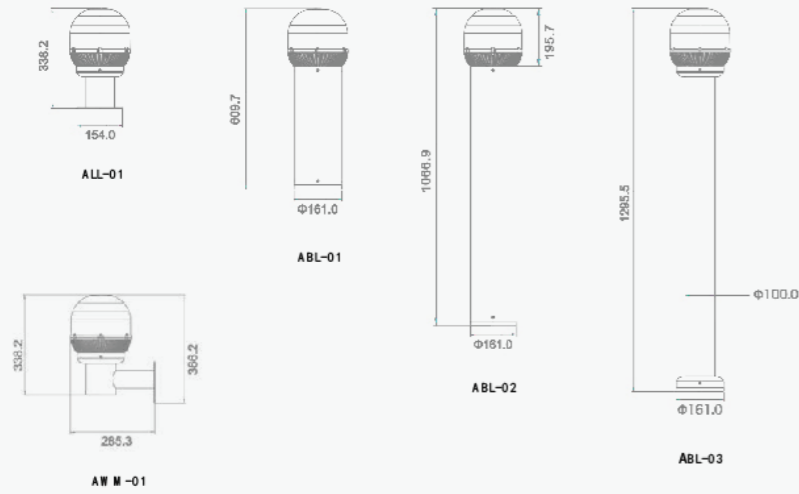

Family Product List

IP 66 AC4.3V

Code No.	Power	Lumen	CCT	LED Quantity
● ABL-01	2.8W	300Lm	3000K	20pcs
● ABL-02	2.8W	300Lm	3000K	20pcs
● ABL-03	2.8W	300Lm	3000K	20pcs
● ALL-01	2.8W	300Lm	3000K	20pcs
● AWM-01	2.8W	300Lm	3000K	20pcs

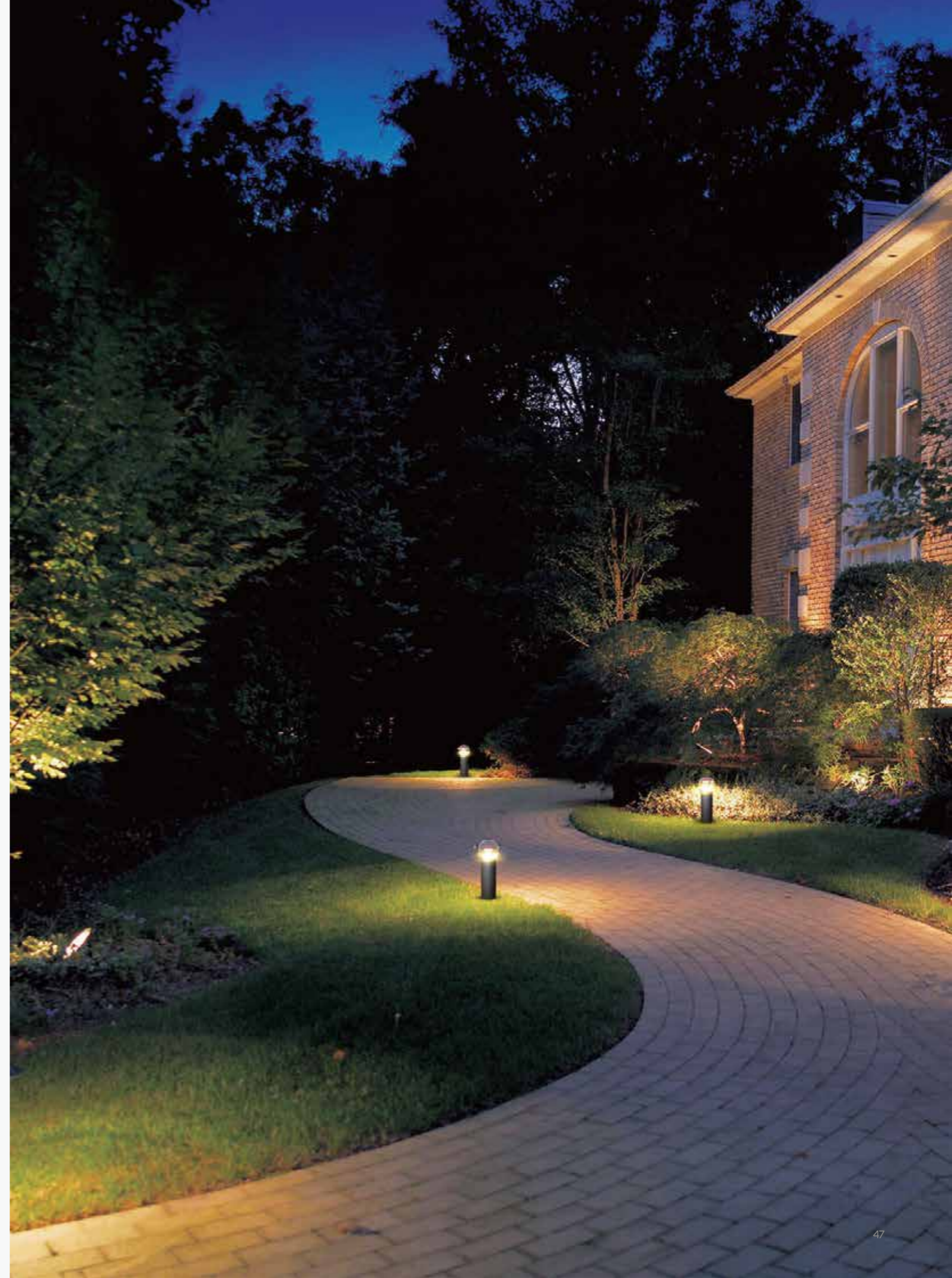

Future

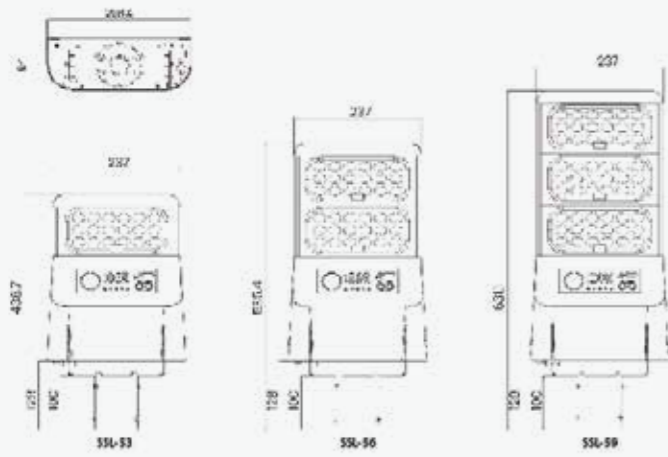

Family Product List

■ Aluminum + PC CR 70 IP 65

Code No.	Power	Input	Lumen	Efficiency	CCT	LED Quantity
● ILL-53	10W	8.8V	3000Lm	230lm/W	3000K / 5700K	18pcs
● ILL-56	16W	13.2V	6000Lm	230lm/W	3000K / 5700K	72pcs
● ILL-59	20W	13.2V	9000Lm	230lm/W	3000K / 5700K	108pcs



World

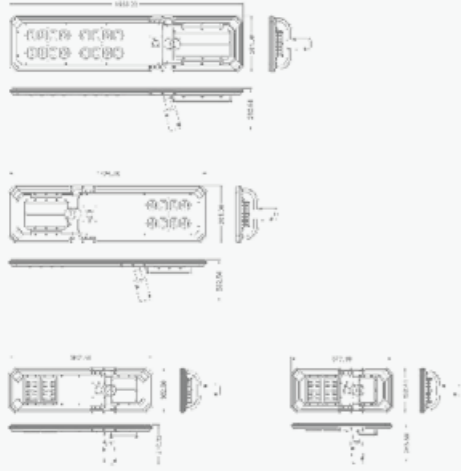

Family Product List

■ Aluminum + PC CR 70 IP 65 ☼ 14.8V

Code No.	Power	Lumen	Efficiency	CCT	LED Quantity
○ IIL-32A	25W	2000LM	230lm/W	5700K	20pcs
○ IIL-34A	37.5W	4000Lm	230lm/W	5700K	40pcs
○ IIL-36A	60W	6000LM	230lm/W	5700K	80pcs
○ IIL-38A	75W	8000Lm	230lm/W	5700K	160pcs
○ IIL-310A	75W	10000Lm	230lm/W	5700K	160pcs



Lava

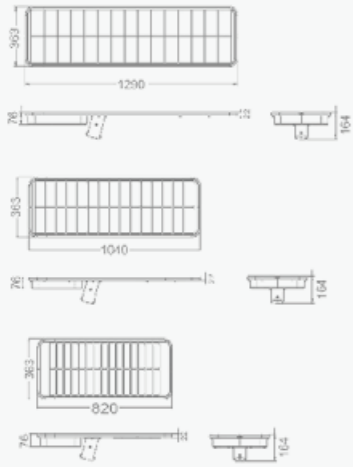

Family Product List

■ Aluminum + PC CR 70 IP 65 ☞ 14.8V

Code No.	Power	Lumen	Efficiency	CCT	LED Quantity
● IIL-92A	37.5W	2000LM	230lm/W	4000K	72pcs
● IIL-94A	37.5W	4000Lm	230lm/W	4000K	72pcs
● IIL-96A	60W	6000LM	230lm/W	4000K	144pcs
● IIL-98A	60W	8000Lm	230lm/W	4000K	144pcs
● IIL-910A	75W	10000Lm	230lm/W	4000K	288pcs
● IIL-912A	75W	12000Lm	230lm/W	4000K	288pcs



Delta

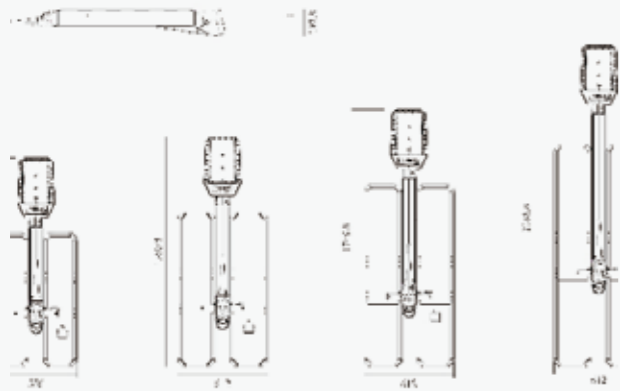

Family Product List

■ Aluminum + PC CR 70 IP 65 □ 14.3V

Code No.	Power	Lumen	Efficiency	CCT	LED Quantity
● ILL-86	60W	6000LM	230lm/W	3000K / 5700K	144pcs
● ILL-88	86W	8000Lm	230lm/W	3000K / 5700K	144pcs
● ILL-810	112W	10000LM	230lm/W	3000K / 5700K	288pcs
● ILL-812	140W	1200Lm	230lm/W	3000K / 5700K	288pcs
● ILL-815	140W	15000Lm	230lm/W	3000K / 5700K	288pcs



Craft

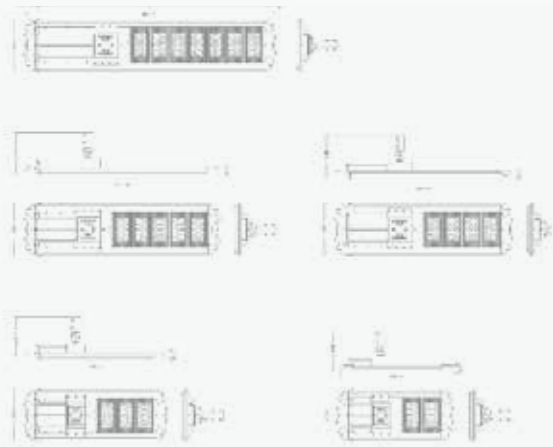

Family Product List

■ Aluminum + PC CR 70 IP 65

Code No.	Power	Input	Lumen	Efficiency	CCT	LED Quantity
○ ILL-72A	35.7W	16.2V	4000Lm	230lm/W	4000K	96pcs
○ ILL-73A	47.5W	16.2V	6000Lm	230lm/W	4000K	144pcs
○ ILL-74A	61.4W	16.2V	8000Lm	230lm/W	4000K	192pcs
○ ILL-75A	78.8W	16.2V	10000Lm	230lm/W	4000K	240pcs
○ ILL-76A	95WW	16.2V	12000Lm	230lm/W	4000K	336pcs



Globe

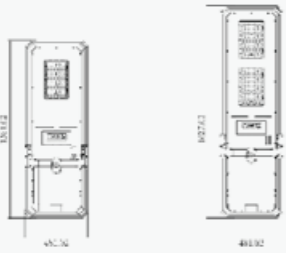

Family Product List

■ AL6063,Q235 Steel,Glass, PC CR 70 IP 65

Code No.	Power	Input	Lumen	Efficiency	CCT	LED Quantity
○ IIL-340	112W	16V	8800Lm	230lm/W	3000K	72pcs
○ IIL-350	112W	16V	11000Lm	230lm/W	3000K	72pcs
○ IIL-360	140W	16V	13200Lm	230lm/W	3000K	144pcs
○ IIL-370	140W	16V	15400Lm	230lm/W	3000K	144pcs



Space

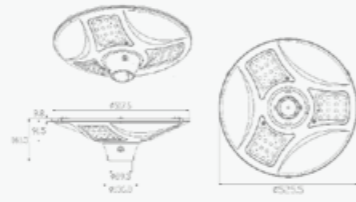

Family Product List

■ Aluminum + PC CR 70 IP 54

Code No.	Power	Input	Lumen	Efficiency	CCT	LED Quantity
○ ILL-12N1	18.75W	16.2V	2000lm	230lm/W	5700K	48pcs



Honor

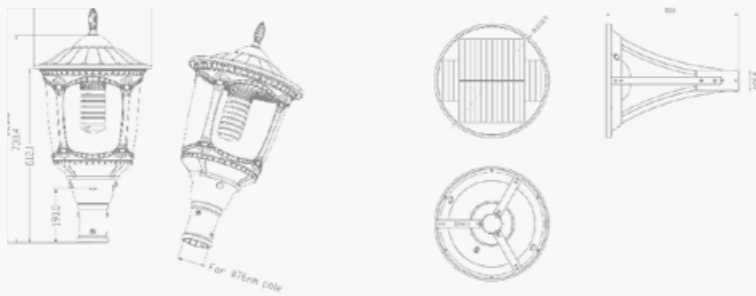

Family Product List

■ Aluminum + PC CR 70 IP 44

Code No.	Power	Input	Lumen	Efficiency	CCT	LED Quantity
● ILL-10F	15W	16.2V	3000LM	230lm/W	5700K	80pcs
● ILL-31	18.75W	16.2V	3000Lm	230lm/W	4000K	42pcs



Ensign

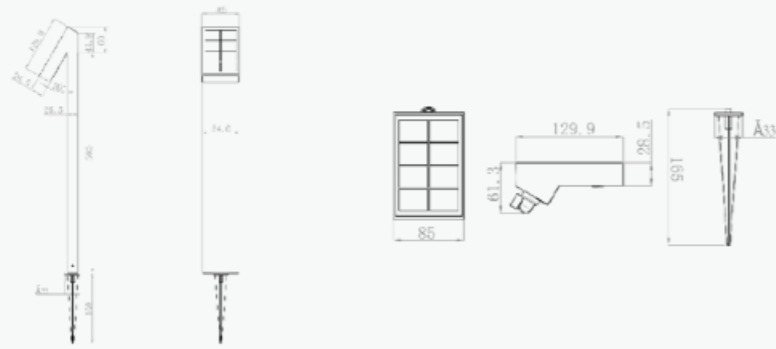

Family Product List

■ ABS+Aluminium CR 70 IP 65

Code No.	Power	Input	Lumen	Efficiency	CCT	LED Quantity
● IGL-15L	1.4W	4.4V	500Lm	230lm/W	3000K	6pcs
● IGL-15S	1.4W	4.4V	500Lm	230lm/W	3000K	6pcs





LED Solar Street Light Luminaire

Sunbeam

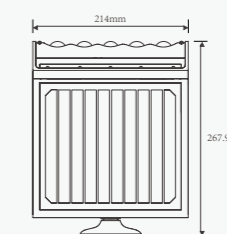
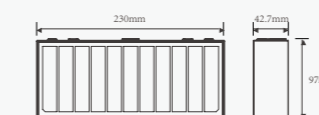

LED Solar Street Light Luminaire

Sunlit

- 613347 6W 3000K 800lm
- 613348 6W 4000K 850lm
- 613349 8.5W 3000K 850lm
- 613350 8.5W 4000K 900lm

■ ABS+PC

IP 65 CRI 80 \angle 110°
 AC220-240V \odot 35,000h



- 613342 8W 3000K 800lm
- 613343 8W 4000K 850lm
- 613344 15W 3000K 1600lm
- 613345 15W 4000K 1650lm
- 613346 40W 4000K 4800lm

■ ABS+PC

IP 65 CRI 80 \angle 110°
 AC220-240V \odot 35,000h



LED Solar Surface-Mounted Luminaire

Sunshine

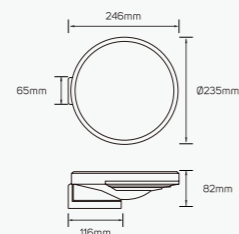

● 614214 4.5W 3000K/4000K 350lm

■ Aluminum+PC

IP 65 CRI 80 120°
 DC5V 35,000h

Tube

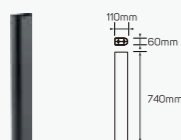

● 614217 ■ Aluminum+PC

LED Solar Surface-Mounted Luminaire

SunBreeze

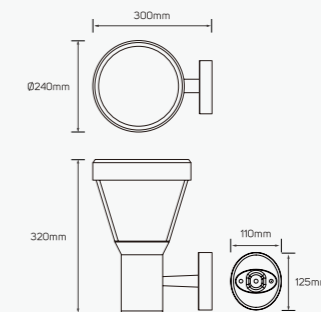

● 614215 4.5W 3000K/4000K 250lm

■ Aluminum+PC

IP 65 CRI 80 180°
 DC5V 35,000h

Tube



● 614217 ■ Aluminum+PC



Galaxy



● 614216 4.5W 3000K/4000K 250lm ■ Aluminum+PC
 IP 65 CRI 80 180°
 DC5V 35,000h

Tube



● 614218 ■ Aluminum+PC



Interstellar



● 614364 2W 3000K 200lm

■ PC+ABS

IP 65 CRI 80 \angle 80°

⏻ 4.5V ⌚ 15,000h



● 614788 1.8W 3000K 100lm

■ PC

IP 65 CRI 80 \angle 30°

⏻ 5.5V ⌚ 15,000h



● 614789 1.5W 3000K 30lm

■ PC

IP 54 CRI 80 \angle 120°

⏻ 5.5V ⌚ 15,000h

Cosmic



● 614783 4W 3000K 300lm

■ ABS +PC

IP 65 CRI 80 \angle 110°
 ⚡ 5V ⌚ 35,000h

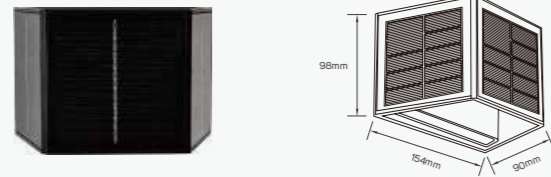

● 614784 1W 3000K 36lm

■ ABS+PC+Glass

IP 65 CRI 80 \angle 90°
 ⚡ 5V ⌚ 35,000h

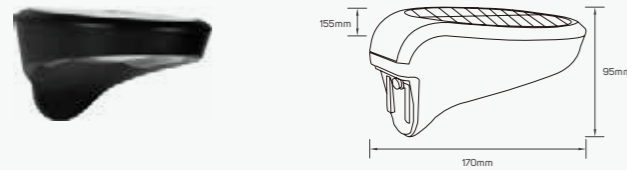

● 614785 2W 3000K 100lm

■ ABS+Glass

IP 65 CRI 80 \angle 110°
 ⚡ 5V ⌚ 35,000h

Accessories

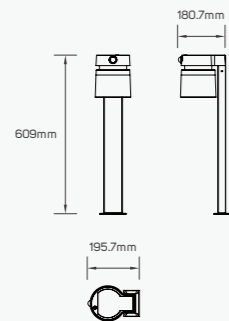

● 614791

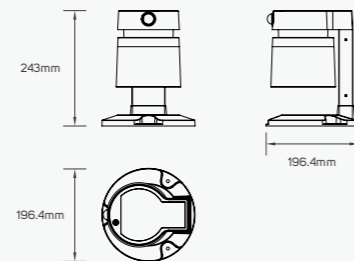

● 614792

Cosmic

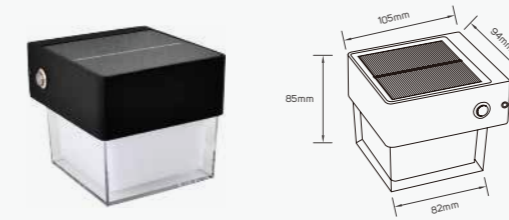

● 614786 1W 3000K 50lm

■ Aluminum+PC

IP 65 CRI 80 \angle 120°
 ⚡ 5V ⌚ 35,000h



● 614787 1W 3000K 36lm

■ Aluminum+PC

IP 65 CRI 80 \angle 120°
 ⚡ 5V ⌚ 35,000h



● 614790 3W 3000K 225lm

■ Aluminum+PC

IP 65 CRI 80 \angle 180°
 ⚡ 5V ⌚ 35,000h



LED Solar Flood Light Luminaire

Star

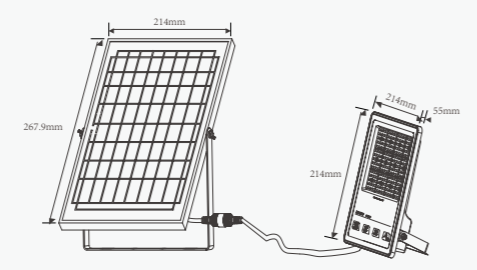

- 613158 5W 3000K 1120lm
- 613159 5W 4000K 1160lm
- 613160 5W 6000K 1210lm

- Aluminum+Silicon
- IP 65 CRI 80  60°
-  AC220-240V  30,000h





LED High Bay Light

High Bay

Areas of Application

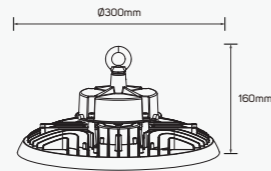
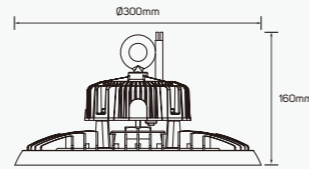
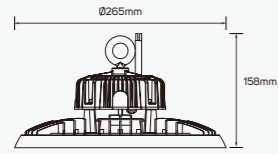
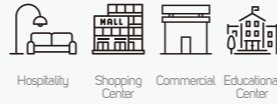

Accessories Specifications

Frame

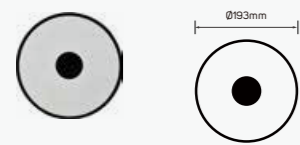

○ 612997

■ Glass

Frame

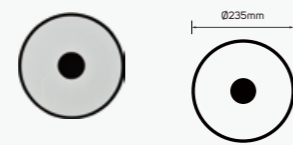

○ 612998

■ Glass

Reflector

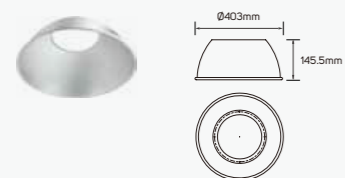

● 612999

■ Aluminum

Reflector

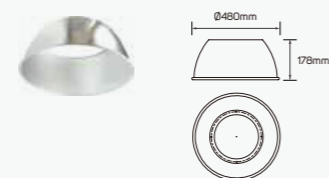

● 613000

■ Aluminum

Accessories Specifications

Reflector

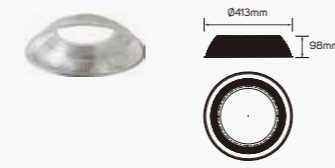

○ 613001

■ Polycarbonate

Reflector



○ 613002

■ Polycarbonate

Bracket

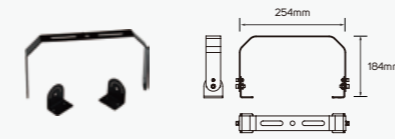

● 613003

● 613004

■ Metal

Suspension Kit

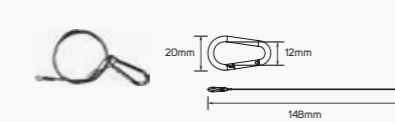

● 613005

■ Metal

Family Product List

Code No.	Power	CCT	Lumen	Beam Angle	Material
● 612988	100W	3000K	11000lm	110°	
● 612989	100W	4000K	12000lm		
● 612990	100W	5700K	13000lm		
● 612997	100W	3000K	22000lm		
● 612991	145W	3000K	16000lm	110°	■ Aluminum
● 612992	145W	4000K	18000lm		
● 612993	145W	5700K	19000lm		
● 612994	195W	3000K	22000lm		
● 612995	195W	4000K	24000lm		
● 612996	195W	5700K	25500lm		
● 613351	200W	4000K	32500lm	90°	IP 65 AC100-277V CRI 85 52,000h

High Bay

Areas of Application

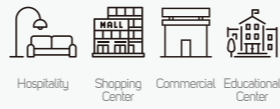

Accessories Specifications

Hook

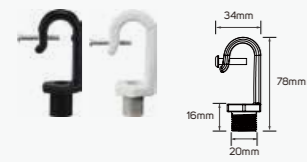

- 614413
- 614414
- Aluminum

Tube

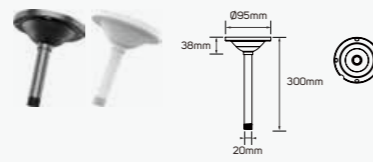

- 614415
- 614417
- Iron

Tube

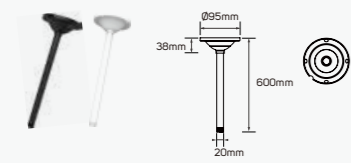

- 614416
- 614418
- Iron

Reflector



- 614419
- 614421
- Aluminum

Reflector

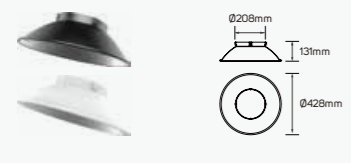

- 614420
- 614422
- Aluminum

Family Product List

Code No.	Power	CCT	
● 614409	100W	11000@3000K	■ Aluminum+Plastic
● 614410	150W	16500@3000K	
● 614411	100W	11000@3000K	IP 20
● 614412	150W	16500@3000K	AC100-240V
			120°
			50,000h





**Architectural &
Decorative**

Horizon

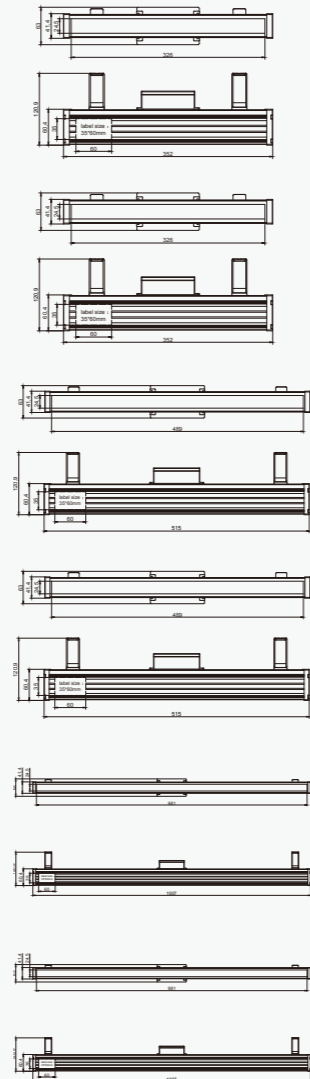

Family Product List

Code No.	Power	CCT	Lumen	Code No.	Power	CCT	Lumen
● LI614582	6W	3000K	390lm	● LI614585	18W	3000K	1150lm
● LI614589	6W	4000K	430lm	● LI614592	18W	4000K	1250lm
● LI614583	9W	3000K	570lm	● LI614586	24W	3000K	1600lm
● LI614590	9W	4000K	630lm	● LI614593	24W	4000K	1750lm
● LI614584	12W	3000K	800lm	● LI614587	36W	3000K	2300lm
● LI614591	12W	4000K	880lm	● LI614594	36W	4000K	2450lm

■ Aluminum+ Glass
 IP 67 CRI 85 ▲ 15°*24°
 □ AC220-240V ⌚ 30,000h

Rosy Dawn

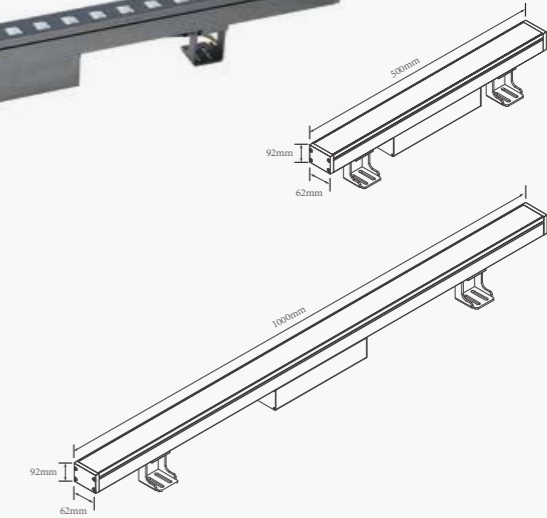

- 612838
- 612837

■ Aluminum

Family Product List

Code No.	Power	CCT	Lumen
● 612833	12W	3000K	800lm
● 612834	18W	3000K	1400lm
● 612835	24W	3000K	1800lm
● 612836	36W	3000K	2800lm

■ Aluminum
 IP 65 CRI 80
 □ AC220-240V ⌚ 30,000h

WallGlow

Technical Operating & Electrical Data

IP Rating	IP65
Power	8.5W
Input	DC24V
Life Span	50000hrs

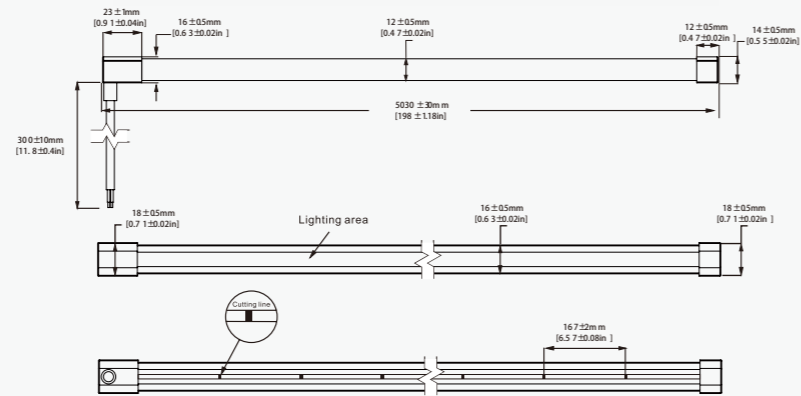

Accessories Specifications

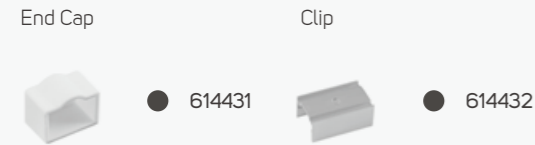

Family Product List

■ Aluminum

Code No.	Power	CCT	Lumen	IP 65	CRI 85	45°	DC24V	50,000h
614514	8.5W/0.5M	3000K	700lm/0.5M	●	●	●	●	●
614515	8.5W/0.5M	4000K	700lm/0.5M	●	●	●	●	●
614516	16W	3000K	1300lm	●	●	●	●	●
614517	16W	4000K	1400lm	●	●	●	●	●

WallCascade

Technical Operating & Electrical Data

IP Rating	IP65
Power	18W
Input	DC24V
Life Span	50000hrs

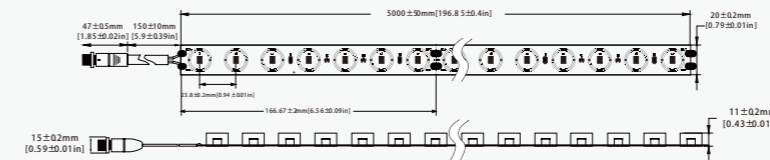

Accessories Specifications

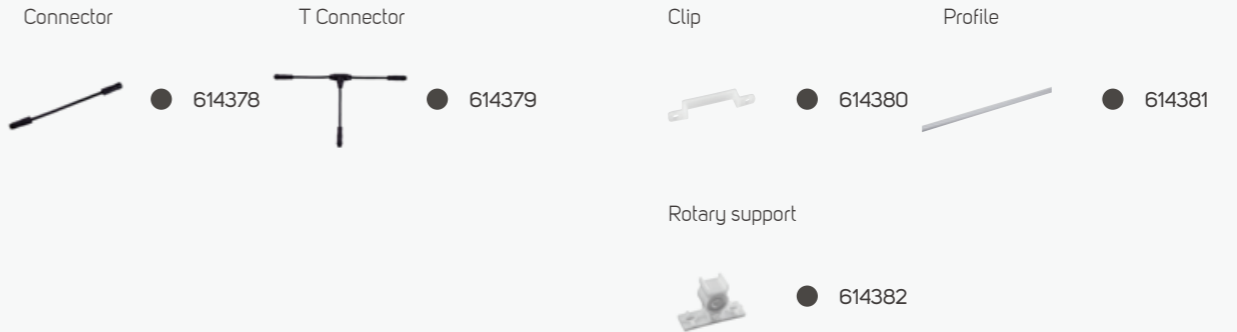

Family Product List

■ Aluminum

Code No.	Power	CCT	Lumen	IP 65	CRI 85	20**30°	DC24V	50,000h
614518	18W	3000K	2100lm	●	●	●	●	●
614519	18W	4000K	2200lm	●	●	●	●	●
614520	18W	3000K	2100lm	●	●	●	●	●
614521	18W	4000K	2200lm	●	●	●	●	●

Sirius

Technical Operating & Electrical Data

IP Rating	IP66
Material	Aluminum+PC
Input	DC24V
Lifespan	50000h

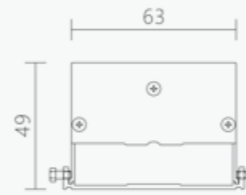

Family Product

IP 66 DC24V

Code No.	LED Qty	Power	CCT	Control Mode
● CH-LIBLYH	48PCS	10.8W	1700K-6000K	ON/OFF
	48PCS	10.8W	RGB	DMX512
	48PCS	10.8W	RGBW	DMX512
	60PCS	12W	1700K-6000K	ON/OFF
	60PCS	12W	RGB	DMX512
	60PCS	15W	RGBW	DMX512



Vega

Technical Operating & Electrical Data

IP Rating	IP66
Material	PC
Input	DC24V
Lifespan	50000h



CH-LIMFXHA1



CH-LIMFXHA2



CH-LIMFXHA3

Family Product

IP 66

DC24V

Code No.	LED Qty	Power	CCT	Control Mode	Beam Angle
● CH-LIMFXHA1	12PCS	3W	1700K-6000K	DMX512	120°
	12PCS	3W	RGBW	DMX512	120°
	9PCS	4.5W	RGBW	DMX512	120°
● CH-LIMFXHA2	6PCS	1.5W	RGB	DMX512	120°
	6PCS	1.8W	RGBW	DMX512	120°
	8PCS	2W	RGBW	DMX512	120°
	6PCS	3W	RGBW	DMX512	120°
● CH-LIMFXHA3	8PCS	1W	RGB	DMX512	120°
	3PCS	1.5W	RGBW	DMX512	120°



Betelgeuse

Technical Operating & Electrical Data

IP Rating	IP66
Material	Aluminum+Glass
Input	AC220V/DC24V
Lifespan	50000h

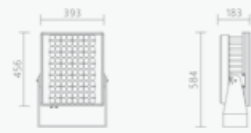

CH-LIPCRYA1

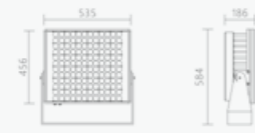

CH-LIPCRYA2

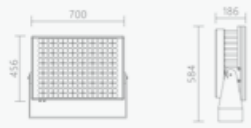

CH-LIPCRYA3

Family Product

IP 66

AC220V/DC24V

Code No.	LED Qty	Power	CCT	Control Mode	Beam Angle
● CH-LIPCRYA1	96PCS	240W	1700K-6000K	ON/OFF	5°/10°/15°/25°/30°/60°
	96PCS	240W	RGB	DMX512	5°/10°/15°/25°/30°/60°
	96PCS	240W	RGBW	DMX512	15°/25°/30°/60°
● CH-LIPCRYA2	144PCS	360W	1700K-6000K	ON/OFF	5°/10°/15°/25°/30°/60°
	144PCS	360W	RGB	DMX512	5°/10°/15°/25°/30°/60°
	144PCS	360W	RGBW	DMX512	15°/25°/30°/60°
● CH-LIPCRYA3	196PCS	500W	1700K-6000K	ON/OFF	5°/10°/15°/25°/30°/60°
	196PCS	500W	RGB	DMX512	5°/10°/15°/25°/30°/60°
	196PCS	500W	RGBW	DMX512	15°/25°/30°/60°



Polaris

Technical Operating & Electrical Data

IP Rating	IP67
Material	Aluminum+Glass
Input	DC24V
Lifespan	50000h



CH-LITLSCA1



CH-LITLSCA2



CH-LITLSCA3

Family Product

IP 67 DC24V

Code No.	LED Qty	Power	CCT	Control Mode	Beam Angle
● CH-LITLSCA1	3PCS	3W	1700K-6000K	ON/OFF	15°/30°/45°
	3PCS	6W	1700K-6000K	ON/OFF	15°/30°/45°
● CH-LIMFXHA2	5PCS	6W	1700K-6000K	ON/OFF	15°/30°/45°
	5PCS	12W	1700K-6000K	ON/OFF	15°/30°/45°
	5PCS	8W	RGBW	DMX512	/

Polaris

Technical Operating & Electrical Data

IP Rating	IP67
Material	Aluminum
Input	AC220V-240V
Lifespan	50000h

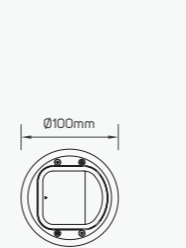

LI615853

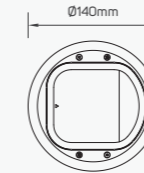

LI615854

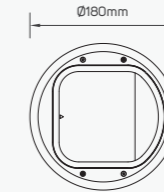

LI615855

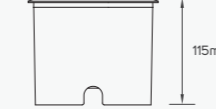
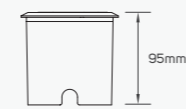

Family Product

IP 67 AC220-240V

Code No.	Power	CCT	Lumen	Beam Angle
● LI615853	7.5W	3000K	285lm	15°
● LI615854	18W	3000K	650lm	15°
● LI615855	30W	3000K	1150lm	15°

Canopus

Technical Operating & Electrical Data

IP Rating	IP66
Material	Aluminum+PC
Input	DC24V
Lifespan	50000h



CH-LICLYA1



CH-LICLYA2

Family Product

IP 66

DC24V

Code No.	LED Qty	Power	CCT	Control Mode
● CH-LIBLYH	48PCS	10.8W	1700K-6000K	ON/OFF
	48PCS	10.8W	RGB	DMX512
	48PCS	10.8W	RGBW	DMX512
	60PCS	12W	1700K-6000K	ON/OFF
	60PCS	12W	RGB	DMX512
	60PCS	15W	RGBW	DMX512

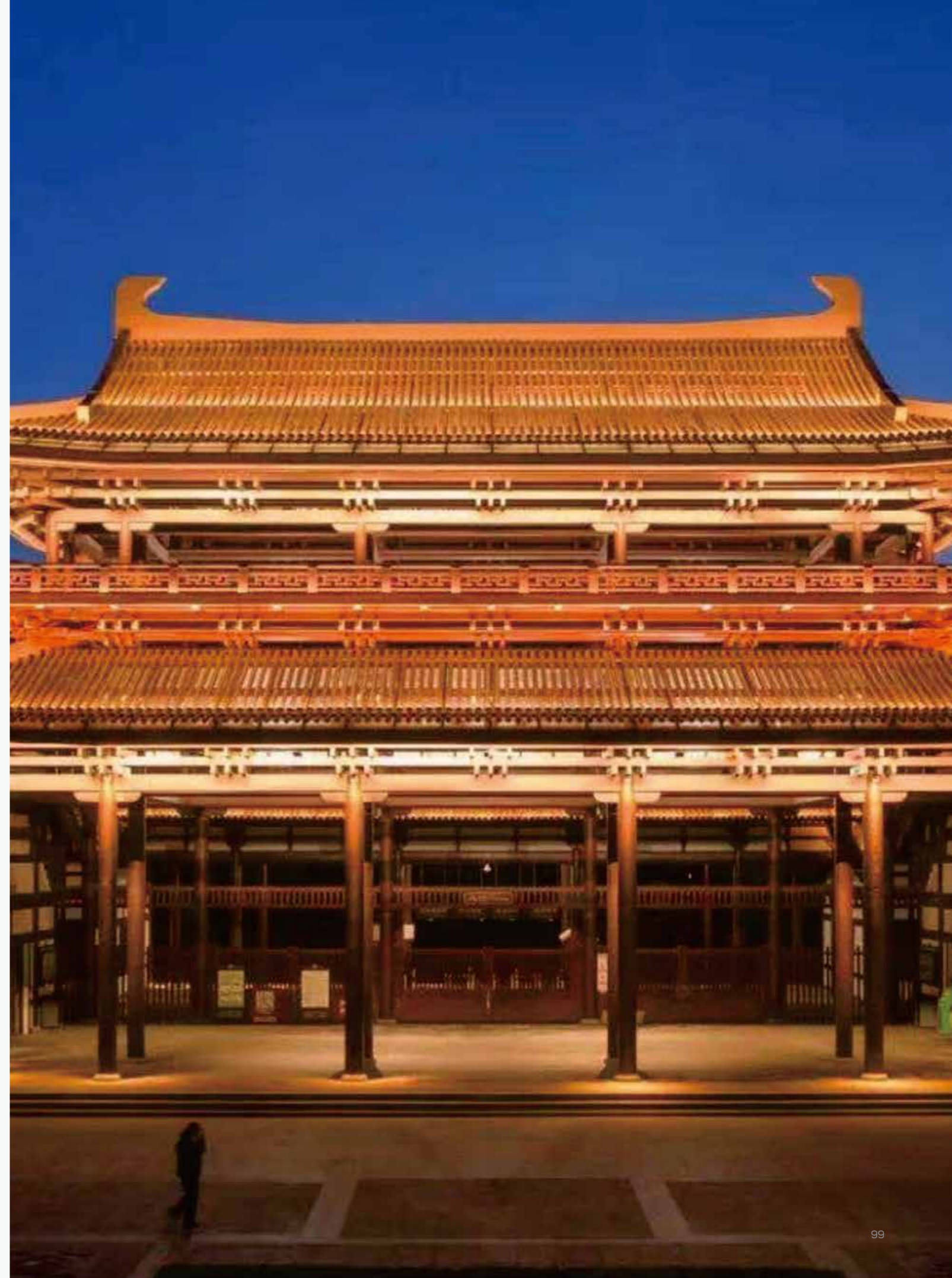

Rigel

Technical Operating & Electrical Data

IP Rating	IP67/68
Material	Aluminum+Glass
Input	DC24V
Lifespan	50000h



CH-LIIGLH



CH-LIIGYH

Family Product

IP 67/68 DC24V

Code No.	LED Qty	Power	CCT	Control Mode	IP	Beam Angle
● CH-LIIGLH	18PCS	18W	1700K-6000K	ON/OFF	67	6°/10°/15°/30°/45°/60°
	24PCS	24W	1700K-6000K	ON/OFF	67	6°/10°/15°/30°/45°/60°
	24PCS	24W	RGB	DMX512	67	6°/10°/15°/30°/45°/60°
	24PCS	24W	RGBW	DMX512	67	6°/10°/15°/30°/45°/60°
	24PCS	60W	RGB	DMX512	67	6°/10°/15°/30°/45°/60°
	24PCS	60W	RGBW	DMX512	67	6°/10°/15°/30°/45°/60°
● CH-LIIGYH	24PCS	60W	1700K-6000K	ON/OFF	68	6°/10°/15°/30°/45°/60°



Antares

Technical Operating & Electrical Data

IP Rating	IP67
Material	Aluminum+Glass
Input	DC24V
Lifespan	50000h

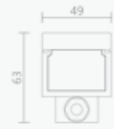
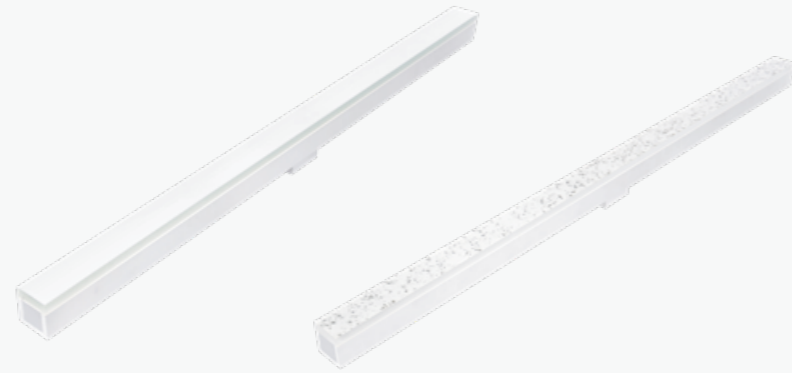

CH-LIGLTXA1



CH-LIGLTXA2

Family Product

IP 67

DC24V

Code No.	LED Qty	Power	CCT	Control Mode
● CH-LIGLTXA1	12PCS	12W	2200K-5000K	ON/OFF
	12PCS	12W	RGBW	DMX512
● CH-LIGLTXA2	12PCS	12W	2200K-5000K	ON/OFF
	12PCS	12W	RGBW	DMX512

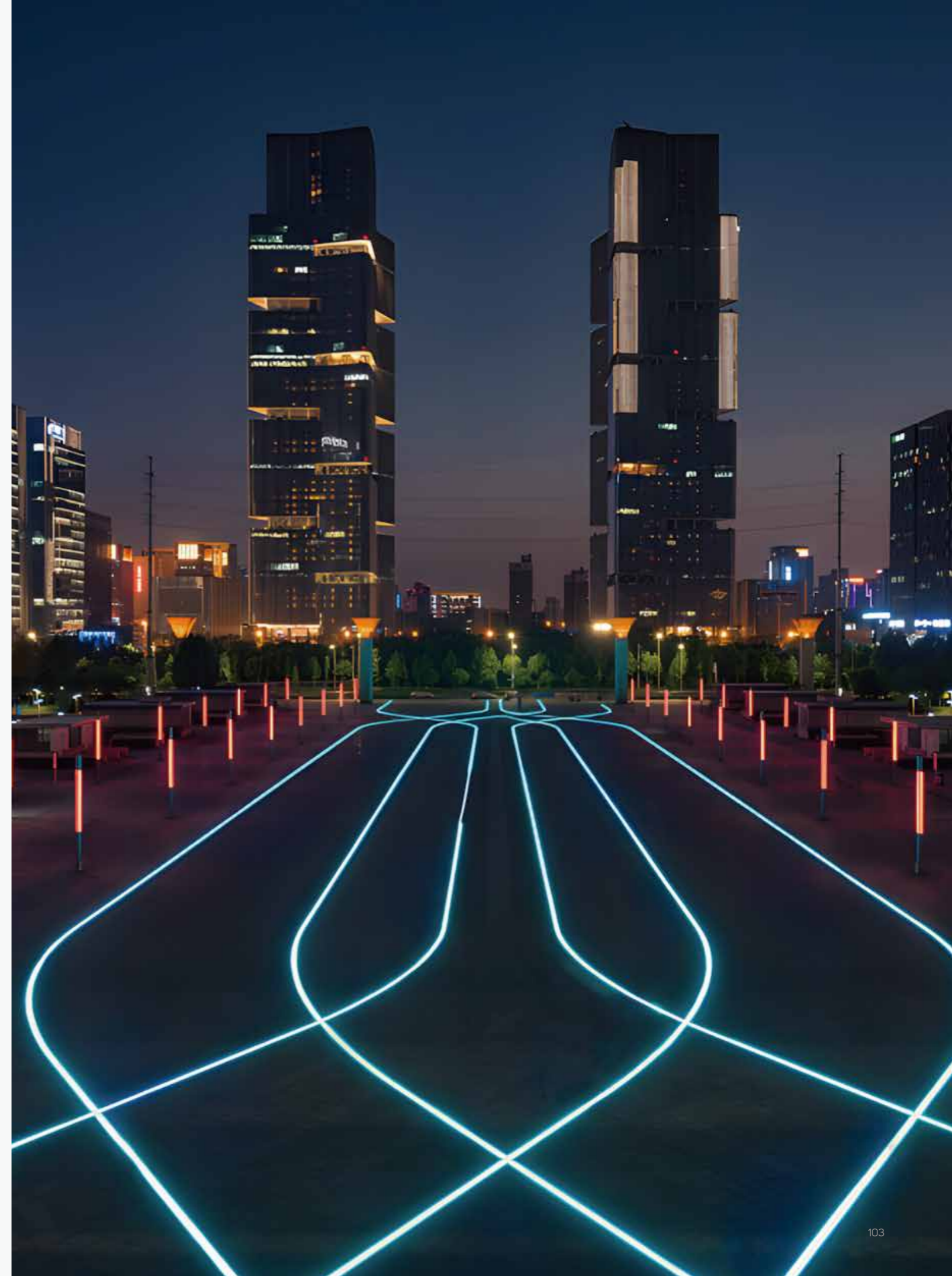

Arcturus

Technical Operating & Electrical Data

IP Rating	IP65
Material	Aluminum
Input	AC220V
Lifespan	50000h



Family Product

IP 65 AC220V

Code No.	LED Qty	Power	CCT	Control Mode
● CH-LIPLTATY	1PCS	150W	3000K-8000K	ON/OFF
● CH-LIPLTXSW	1PCS	40W	3000K-8000K	ON/OFF
● CH-LIPLXKTY	1PCS	40W	3000K-6000K/Blue light	ON/OFF
● CH-LIPLSWTY	2PCS	16W	Laser/Blue light	ON/OFF





Summer

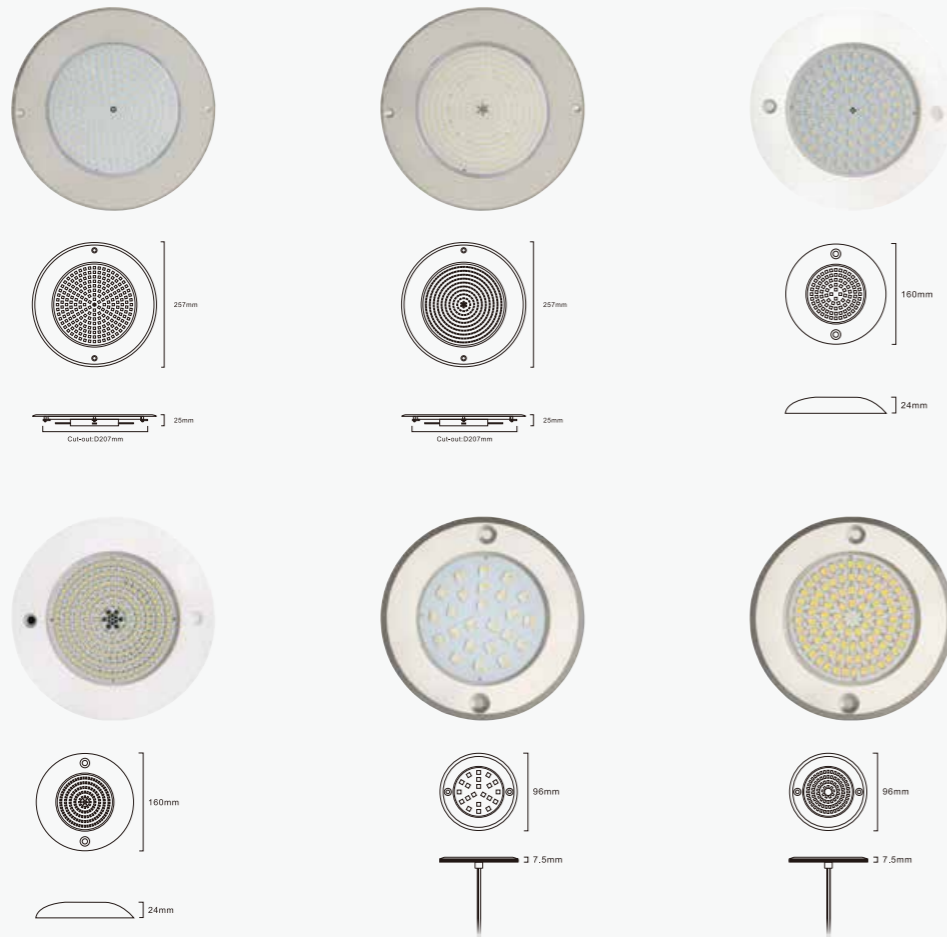

Tyua Controller



Family Product List

CRI 85 120° 50,000h

Code No.	Model No.	Watt	Lumen	CCT	IP	Voltage	Material
LI614914	ILS36WSPOLRGBW01	36W	1800	RGBW(5000K)	68	DC12V	Stainless Steel
LI614915	ILS36WSPOL850DL01	36W	3300	Day White 5000K	68	AC/DC12V 50/60Hz	Stainless Steel
LI614916	ILS15WSPOLRGBW01	15W	750	RGBW(5000k)	68	DC12V	PC
LI614917	ILS15WSPOL850DL01	15W	1500	Day White 5000K	68	AC/DC12V 50/60Hz	PC
LI614918	ILS10WSPOLRGBW01	10W	450	RGBW(5000k)	68	DC12V	Stainless Steel
LI614919	ILS10WSPOL850DL01	10W	900	Day White 5000K	68	AC/DC12V 50/60Hz	Stainless Steel
LI614920	ILSDMXRC02	144W		N/A	20	DC12V	PC

Summer



Accessories Specifications

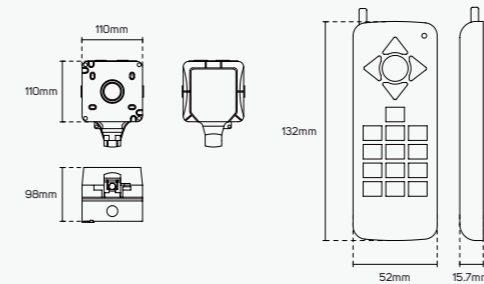

○ 614904 (RGBW)

Family Product List

Glass IP 68 CRI 85 100° 50,000h

Code No.	Model No.	Watt	Lumen	CCT	Voltage
614877	ILS18WSPOL830WW01	18W	2000lm	3000K	AC/DC12V
614878	ILS18WSPOL850DL01	18W	2100lm	5000K	AC/DC12V
614879	ILS18WSPOLRGBWL01	18W	2200lm	RGBW. W=5000K	AC12
614880	ILS30WSPOL830WW01	30W	3300lm	3000K	AC/DC12V
614881	ILS30WSPOL850DL01	30W	3500lm	5000K	AC/DC12V
614882	ILS28WSPOLRGBWL01	28W	3200lm	RGBW. W=5000K	AC12V

Summer

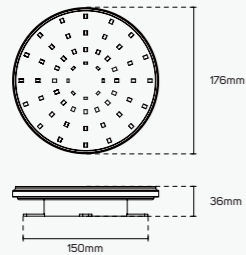

Accessories Specifications

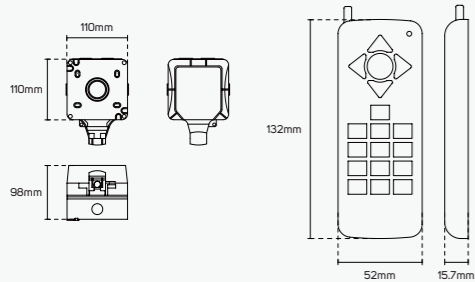

○ 614904

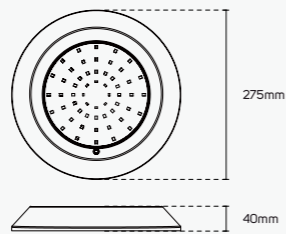

○ 614889 - 614890

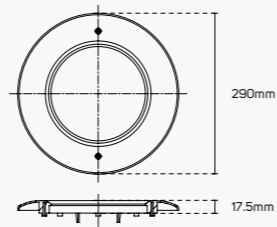

○ 614891

Family Product List

■ PC IP 68 CRI 85 100° 50,000h

Code No.	Model No.	Watt	Lumen	CCT	Voltage
○ 614883	ILS18WSPOL830WW02	18W	2000lm	3000K	AC/DC12V
○ 614884	ILS18WSPOL850DL02	18W	2050lm	5000K	AC/DC12V
○ 614885	ILS18WSPOLRGBWL02	18W	2100lm	RGBW. W=5000K	AC12V
○ 614886	ILS30WSPOL830WW02	30W	3150lm	3000K	AC/DC12V
○ 614887	ILS30WSPOL850DL02	30W	3300lm	5000K	AC/DC12V
○ 614888	ILS28WSPOLRGBWL02	28W	3200lm	RGBW. W=5000K	AC12V

Summer

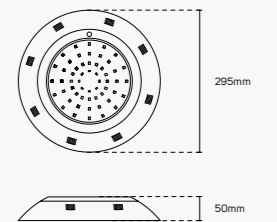

Accessories Specifications

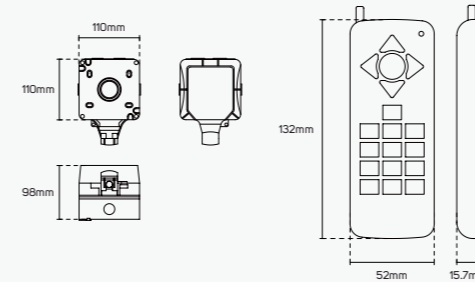

○ 614904 (RGBW)

Family Product List

■ PC IP 68 CRI 85 100° 50,000h

Code No.	Model No.	Watt	Lumen	CCT	Voltage
○ 614892	ILS18WSPOL830WW03	18W	1900lm	3000K	AC/DC12V
○ 614893	ILS18WSPOL850DL03	18W	1950lm	5000K	AC/DC12V
○ 614894	ILS18WSPOLRGBWL03	18W	2000lm	RGBW. W=5000K	AC12V
○ 614895	ILS30WSPOL830WW03	30W	3100lm	3000K	AC/DC12V
○ 614896	ILS30WSPOL850DL03	30W	3200lm	5000K	AC/DC12V
○ 614897	ILS28WSPOLRGBWL03	28W	2850lm	RGBW. W=5000K	AC12V

LED Swimming Pool Light

Swing

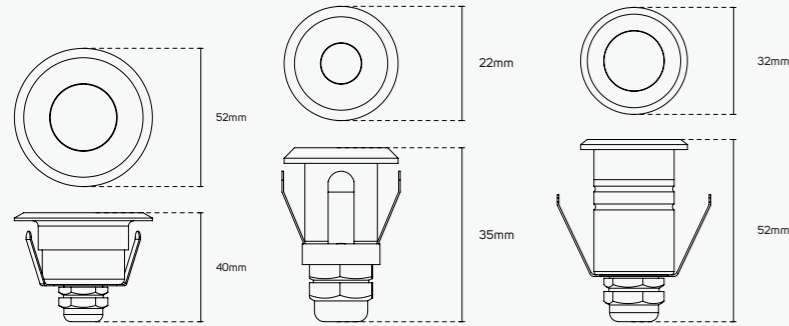

Accessories Specifications

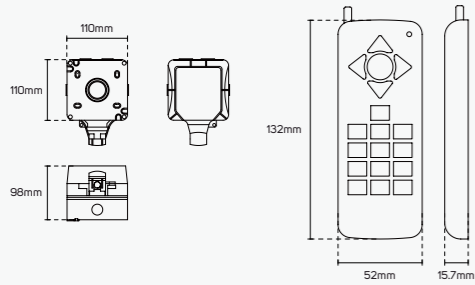

○ 614904 (RGBW)

Family Product List

■ Stainless Steel IP 68 CRI 80 DC12V 50,000h

Code No.	Model No.	Watt	Lumen	CCT	Beam Angle
○ 614898	ILS2WMISPOL830WW01	2W	180lm	3000K	30°
○ 614899	ILS2WMISPOL850DL01	2W	190lm	5000K	30°
○ 614900	ILS05WMISPOL830WW01	0.5W	13lm	3000K	60°
○ 614901	ILS05WMISPOL850DL01	0.5W	14lm	5000K	60°
○ 614902	ILS1WMISPOL830WW02	1W	80lm	3000K	24°
○ 614903	ILS1WMISPOL850DL02	1W	85lm	5000K	24°

Waterproof Transformer

Swing

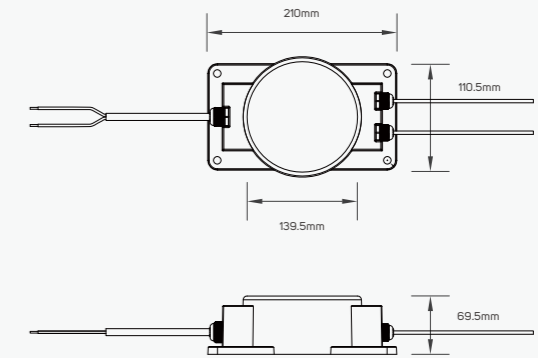
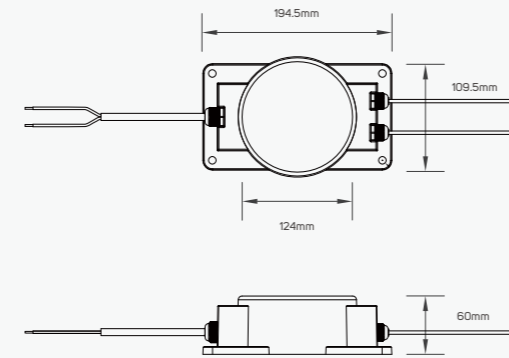

Family Product List

■ Copper IP 67 AC220-240V 25,000h

Code No.	Model No.	Watt	Ampere
● 615604	ILS120SPACDB01	120W	10A
● 615605	ILS120SPACDB01	300W	25A

Accessories



Waterproof Connector

Accessories

Technical Operating & Electrical Data

IP Rating IP68

Areas of Application

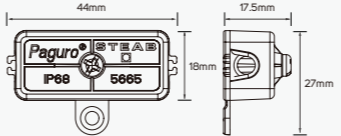
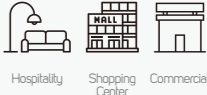

● 211032 IP 68 250V / 6A ■ Inner: 2x0.75mm Outer: 4.8-6mm

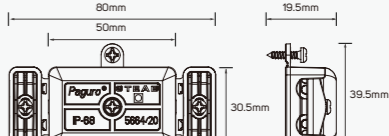

● 211033 IP 68 250V / 6A ■ Inner: 2x1mm Outer: 4.5-8.5mm

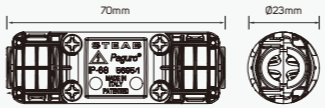

● 211034 IP 68 250V / 10A ■ Inner: 3x1.5mm Outer: 5.5-10mm

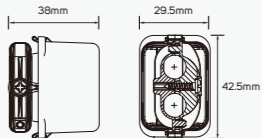

● 211035 IP 68 250V / 10A ■ Inner: 3x1.5mm Outer: 8-10mm

Accessories

Technical Operating & Electrical Data

Body Material Aluminum
IP Rating IP68

Areas of Application

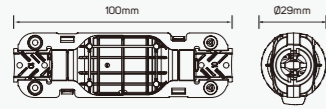
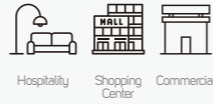

● 211036 ■ Inner: 3x2.5mm
Outer: 6.5-12mm
IP 68 ⚡ 250V / 16A

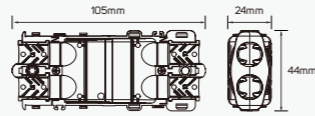

● 211037 ■ Inner: 3x2.5mm
Outer: 6.5-12mm
IP 68 ⚡ 250V / 16A

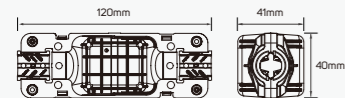

● 211038 ■ Inner: 3x4mm
Outer: 7.5-16mm
IP 68 ⚡ 450V / 25A

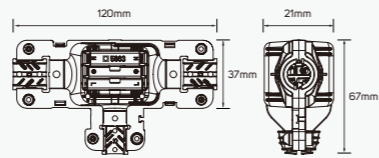

● 211039 ■ Inner main line: 3x6mm Derivation: 3x2.5mm
Outer main line: 7.5-16mm Derivation: 6.5-12mm
IP 68 ⚡ 450V / 25A

Accessories

Technical Operating & Electrical Data

Body Material Aluminum
IP Rating IP68

Areas of Application

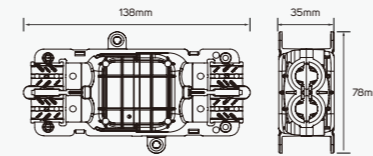
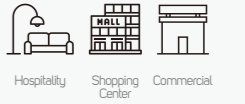

● 211040 ■ Inner: 3x4mm
Outer: 7.5-16mm
IP 68 ⚡ 450V / 25A

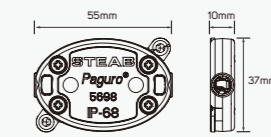

● 211041 ■ Inner: 3x1mm
Outer: 5-7mm
IP 68 ⚡ 250V / 6A

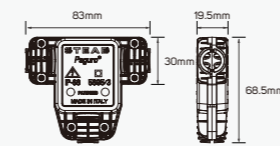

● 211042 ■ Inner main line: 3x2.5mm Derivation: 3x1.5mm
Outer main line: 6.5-12mm Derivation: 5.5-10mm
IP 68 ⚡ 250V / 16A

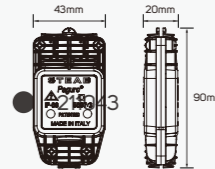

● 211043 ■ Inner: 3x2.5mm
Outer: 6.5-12mm
IP 68 ⚡ 250V / 16A

Accessories

Technical Operating & Electrical Data

Body Material Aluminum
 IP Rating IP68

Areas of Application

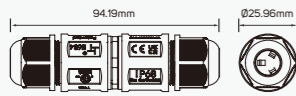
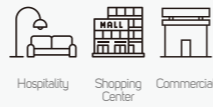

● 613167 ■ 2xM20 (D8-4mm)
 IP 68 □ 450V / 24A

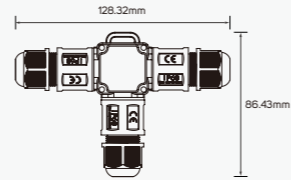

● 613776 ■ 3xM20 (4-8mm/6-11mm) ● 613777
 IP 68 □ 450V / 24A

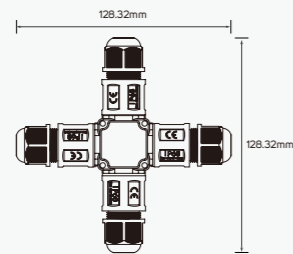

■ 4xM20 (4-8mm/6-11mm)
 IP 68 □ 450V / 24A

Accessories

Technical Operating & Electrical Data

IP Rating IP68

Areas of Application

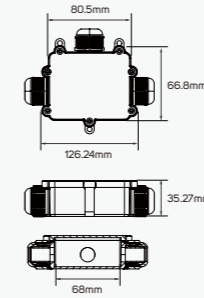
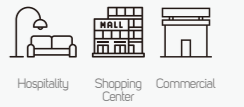

● 614508 ■ PC

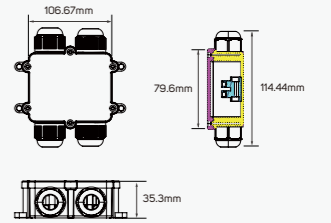

● 614509 ■ PC

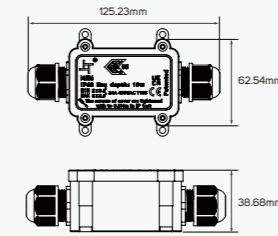

● 614510 ■ PC

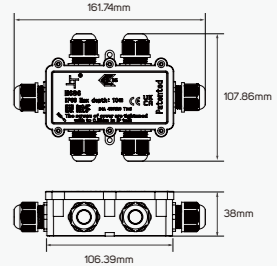

● 614511 ■ PC

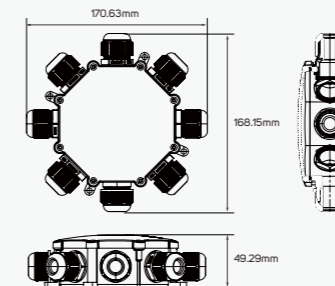

● 614512 ■ PC

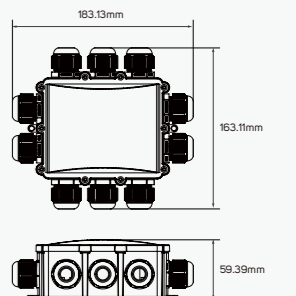

● 614513 ■ PC



Indoor Project Lighting

Polly



Three kinds of hole openings

55/75/95 three specifications to meet the installation requirements of different scenarios.



Adjustable angle

The lamp body to a maximum angle of 30 °
Easy switching between direct illumination mode / wall washing mode.



Rotatable

Rotate the light body, can be rotated horizontally 355°, easy to adjust the lighting Angle.

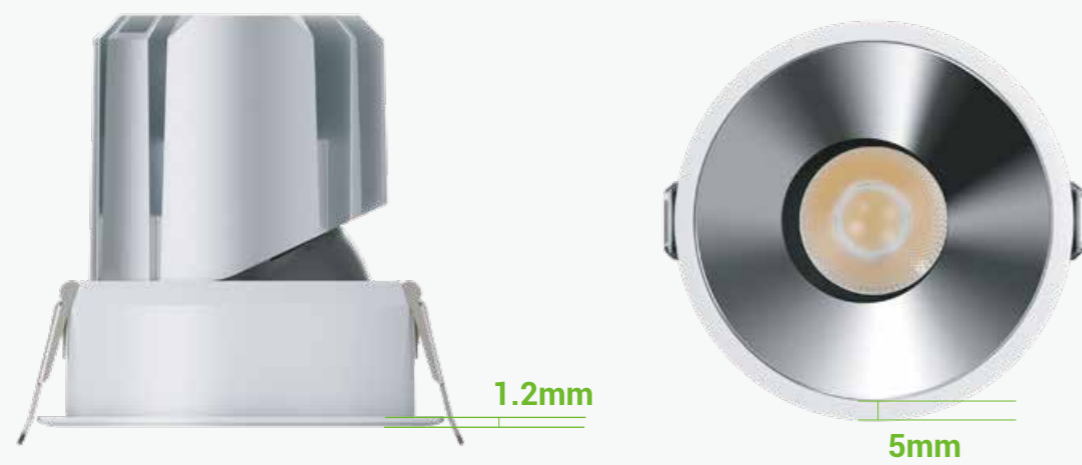

Ultra-thin design

Ultra-thin design, frame narrow to 5mm, thickness 1.2mm, making the ceiling and lighting fixtures more integrated.

MULTIPLE CHOICES



MULTIPLE CHOICES



POLLY-75
liner



Round



Round beam



Integrated trimless

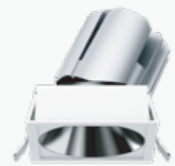

Square trim - single head



Square trim - double head



Square trimless single head



Square trimless double head



gold

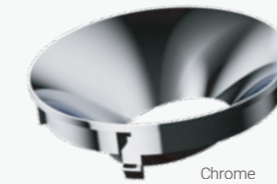

Chrome



Gun black



Matt White



Matt Black



Sand silver

Available in 6 colors

Available in 6 colors

Suitable for different decoration environments

The reflector is precisely designed with electroplating (anti UV) and nano paint technology, which is suitable for different soft decoration environments

Polly



LOW GLARE STRONG PENETRATION



PL-100902E55

Power: 9W
Size(WxH): Ø62x85mm
Cutout: Ø55
Beam angle: 15°/24°/36°/50°
IP: IP20
Standard holder:1304

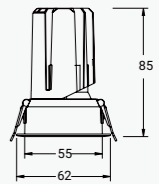

PL-100903E55

Power: 9W
Size(WxH): Ø65x86mm
Cutout: Ø55
Beam angle: 15°/24°/36°/50°
IP: IP20
Standard holder:1304

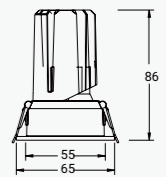

PL-100902YT55

Power: 9W
Size(WxH): Ø85x85mm
Cutout: Ø55
Beam angle: 15°/24°/36°/50°
IP: IP20
Standard holder:1304

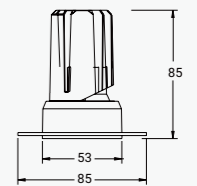

Polly



PL-100902P55

Power: 9W
 Size(WxH): 68x68x86.5mm
 Cutout: 60x60mm
 Beam angle: 15°/24°/36°/50°
 IP: IP20
 Standard holder: 1304

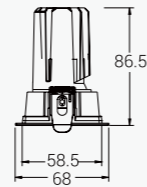

PL-100902P55-2

Power: 9W
 Size(WxH): 135x68x86.5mm
 Cutout: 128x60mm
 Beam angle: 15°/24°/36°/50°
 IP: IP20
 Standard holder: 1304

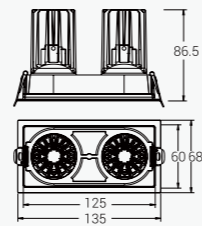

PL-100902P55-3

Power: 3x9W
 Size(WxH): 202x68x86.5mm
 Cutout: 195x60mm
 Beam angle: 15°/24°/36°/50°
 IP: IP20
 Standard holder: 1304

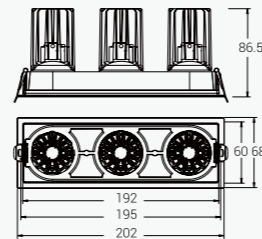

Reflector cover: Optional:

Polly



PL-100902PT55

Power: 9W
 Size(WxH): 138x65x86.5mm
 Cutout: 65x65mm
 Beam angle: 15°/24°/36°/50°
 IP: IP20
 Standard holder: 1304

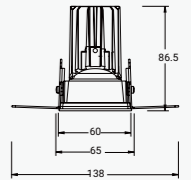

PL-100902PT55-2

Power: 2x9W
 Size(WxH): 205x60x86.5mm
 Cutout: 133x65mm
 Beam angle: 15°/24°/36°/50°
 IP: IP20
 Standard holder: 1304

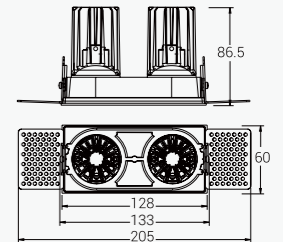

PL-100902PT55-3

Power: 3x9W
 Size(WxH): 272x60x86.5mm
 Cutout: 200x65mm
 Beam angle: 15°/24°/36°/50°
 IP: IP20
 Standard holder: 1304

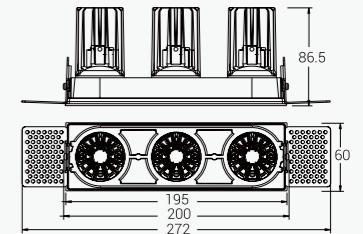

Reflector cover: Optional:

Polly



PL-100902E75

Power: 13W
 Size(WxH): Ø82x85mm
 Cutout: Ø75mm
 Beam angle: 10°/15°/24°/36°/50°
 IP: IP20
 Standard holder:1304
 Optional holder: 1507

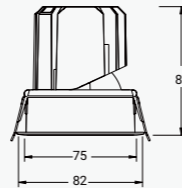

PL-100903E75

Power: 13W
 Size(WxH): Ø85x84.5mm
 Cutout: Ø75mm
 Beam angle: 10°/15°/24°/36°/50°
 IP: IP20
 Standard holder:1304
 Optional holder: 1507

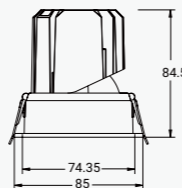

PL-100902YT75

Power: 13W
 Size(WxH): Ø108x85mm
 Cutout: Ø75mm
 Beam angle: 10°/15°/24°/36°/50°
 IP: IP20
 Standard holder:1304
 Optional holder: 1507

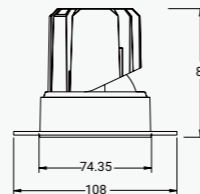

Reflector cover: Optional:

Polly



PL-100902P75

Power: 13W
 Size(WxH): 85x85x86.5mm
 Cutout: 75x75mm
 Beam angle: 10°/15°/24°/36°/50°
 IP: IP20
 Standard holder:1304
 Optional holder: 1507

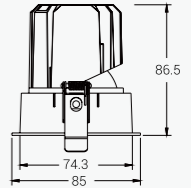

PL-100902P75-2

Power: 2x13W
 Size(WxH): 160x85x86.5mm
 Cutout: 155x75mm
 Beam angle: 10°/15°/24°/36°/50°
 IP: IP20
 Standard holder:1304
 Optional holder: 1507

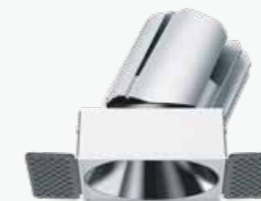
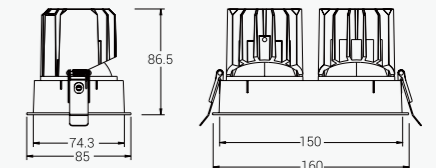

PL-100902PT75

Power: 13W
 Size(WxH): 129x75x86.5mm
 Cutout: 75x75mm
 Beam angle: 10°/15°/24°/36°/50°
 IP: IP20
 Standard holder:1304
 Optional holder: 1507

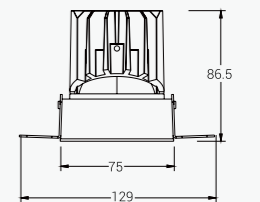

Reflector cover: Optional:

Polly



PL-100902PT75-2

Power: 2x13W
 Size(WxH): 204x75x86.5mm
 Cutout: 155x75mm
 Beam angle: 10°/15°/24°/36°/50°
 IP: IP20
 Standard holder:1304
 Optional holder: 1507

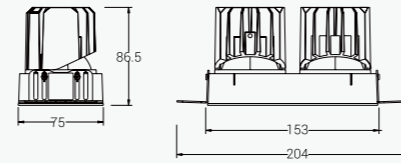

PL-100902E95

Power: 25W
 Size(WxH): Ø105x115mm
 Cutout: Ø95mm
 Beam angle: 15°/24°/36°/50°
 IP: IP20
 Standard holder:1507
 Optional holder: 1304/020

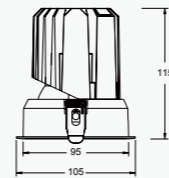

PL-100902YT95

Power: 25W
 Size(WxH): Ø128x115mm
 Cutout: Ø95mm
 Beam angle: 15°/24°/36°/50°
 IP: IP20
 Standard holder:1507
 Optional holder: 1304/020

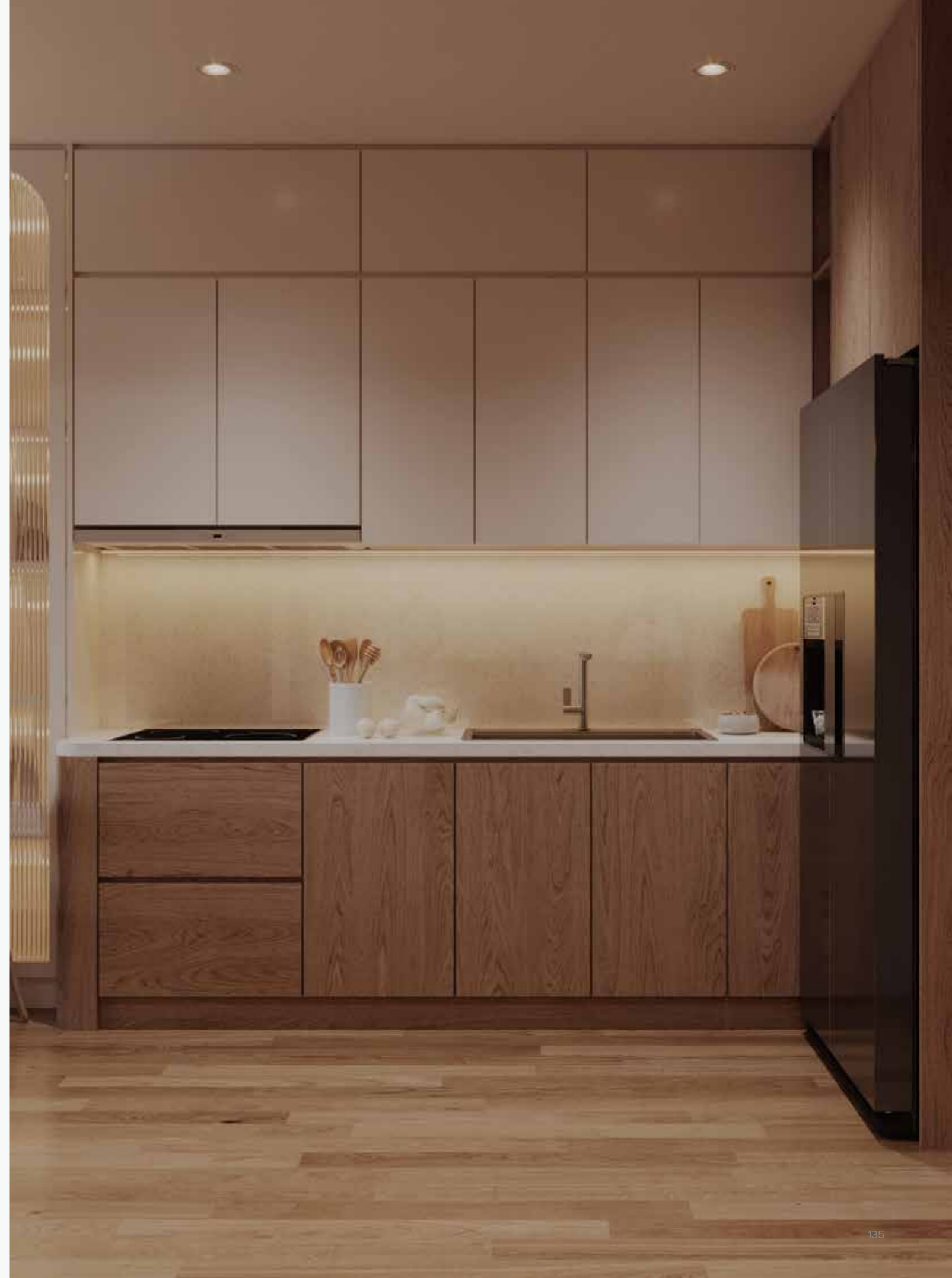
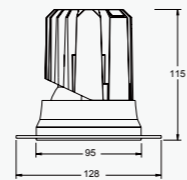

Saira



IP65

URG<6

- * The lamp has passed IP65 waterproof test and 500h of salt spray test.
- * Ultra-thin design, frame narrow to 5mm, thickness 1.2mm.
- * Deep anti glare, UGR<6.
- * Seven sizes available, $\phi 35/\phi 45/\phi 55/\phi 65/\phi 75/\phi 95/\phi 120$.
- * 12 colours are available as custom options.

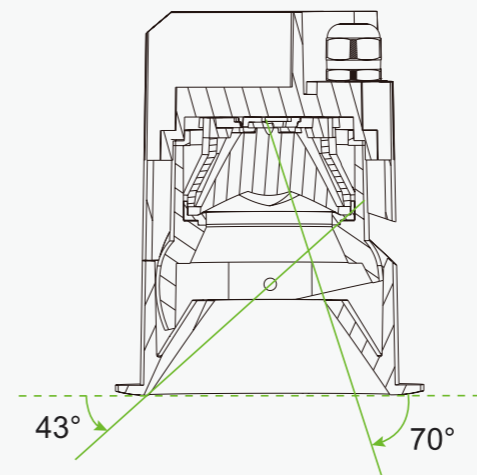

Beauty, more than one



Multi-coloured face rings ,The reflector is multi-color and can meet the needs of different occasions.The reflector is precisely designed,plated and nano spray painted Comfortable light type with high reflection efficiency and high efficiency.

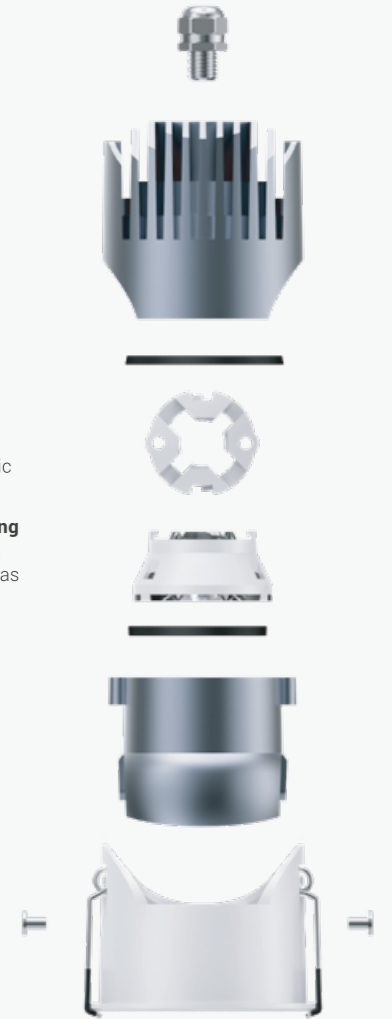
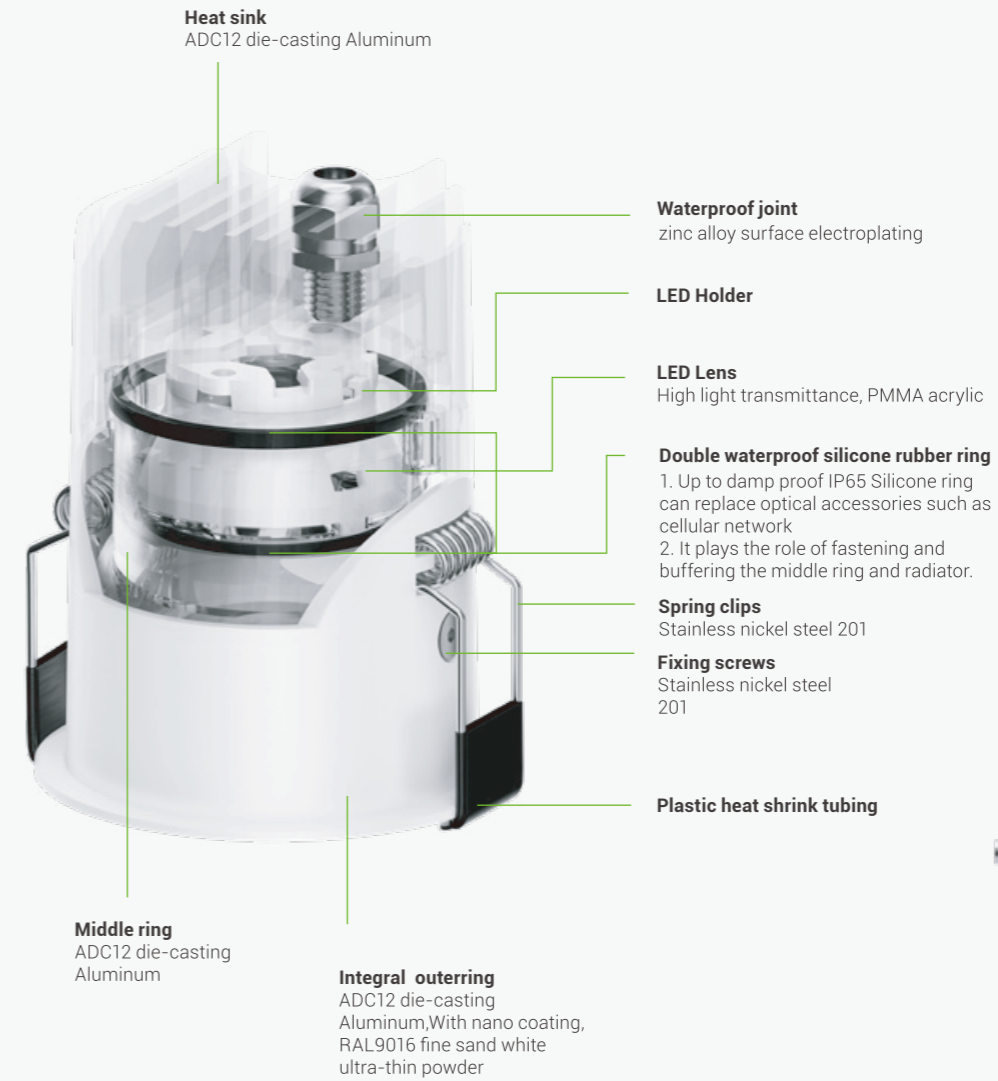

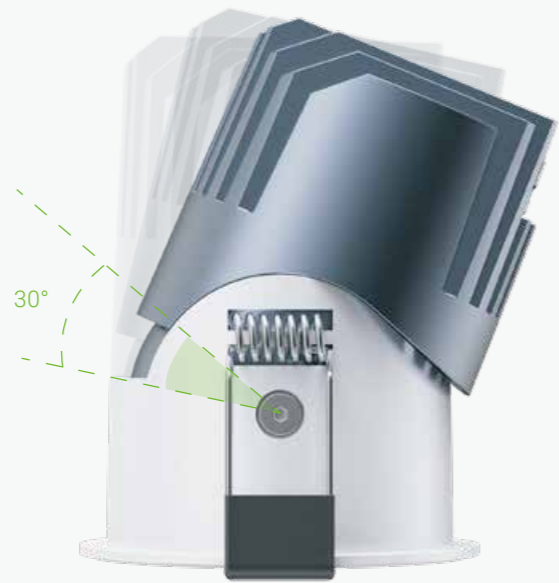

0~30°

Stepless regulation 0~30° at any angle

Ultra-thin design



Seven product sizes



Optical Lens and Reflector can be switched



IP65 | Waterproof

Not afraid of water/fog/oil/smoke can be used in the hotel, ballroom.
The lamp has passed 500 hours of salt spray testing and IP65 waterproof testing.

Saira



XQ-1005E35

7W | Ø35mm

Power: 7W
 Cutout: Ø35mm
 Size(WxH): Ø40X85mm
 Beam angle: 15°/24°/36°
 IP: IP44 (Lens)
 Standard holder: **CREE** 1304

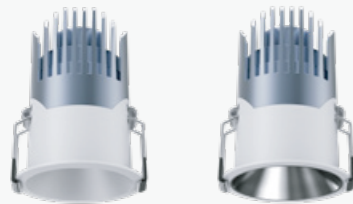
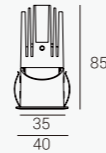

XQ-1005E45

7W | Ø45mm

Power: 7W
 Cutout: Ø45mm
 Size(WxH): Ø52X72mm
 Beam angle: 10°/15°/24°/36° (Lens)
 Beam angle: 18°/24°/38° (Reflector)
 IP: IP65 (Lens)
 IP: IP40 (Reflector)
 Standard holder: **CREE** 1304

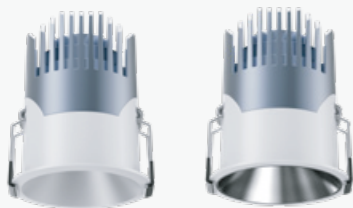
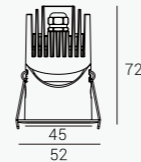

XQ-1005E55

9W | Ø55mm

Power: 9W
 Cutout: Ø55mm
 Size(WxH): Ø62X77mm
 Beam angle: 10°/15°/24°/36°/50° (Lens)
 Beam angle: 18°/24°/38° (Reflector)
 IP: IP65 (Lens)
 IP: IP40 (Reflector)
 Standard holder: **CREE** 1304
 Optional holder: **CREE** 1507

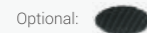
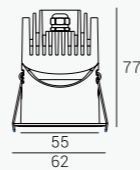

Saira



XQ-1005E65

12W | Ø65mm

Power: 12W
 Cutout: Ø65mm
 Size(WxH): Ø73X80mm
 Beam angle: 10°/15°/24°/36°/50° (Lens)
 Beam angle: 18°/24°/38° (Reflector)
 IP: IP65 (Lens)
 IP: IP40 (Reflector)
 Standard holder: **CREE** 1304
 Optional holder: **CREE** 1507 / **LUMINUS** CXM-6

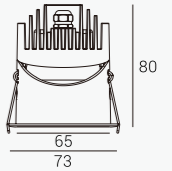

XQ-1005E75

15W | Ø75mm

Power: 15W
 Cutout: Ø75mm
 Size(WxH): Ø84X85mm
 Beam angle: 10°/15°/24°/36°/50° (Lens)
 Beam angle: 18°/24°/38° (Reflector)
 IP: IP65 (Lens)
 IP: IP40 (Reflector)
 Standard holder: **CREE** 1507
 Optional holder: **CREE** 1304 / **LUMINUS** CXM-6/9

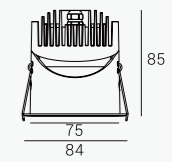

XQ-1005E95

30W | Ø95mm

Power: 30W
 Cutout: Ø95mm
 Size(WxH): Ø103X110mm
 Beam angle: 15°/24°/36°/50° (Lens)
 Beam angle: 18°/24°/38° (Reflector)
 IP: IP65 (Lens)
 IP: IP40 (Reflector)
 Standard holder: **CREE** 1507
 Optional holder: **CREE** 1304 / 020

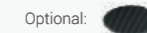
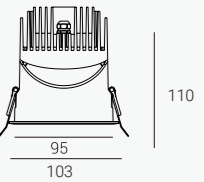

Saira



XQ-1005E120

Power:	38W
Cutout:	Ø120mm
Size(WxH):	Ø130X135mm
Beam angle:	15°/24°/36°/55° (Lens)
Beam angle:	18°/24°/38° (Reflector)
IP:	IP65 (Lens)
IP:	IP40 (Reflector)
Standard holder:	1816
Optional holder:	030/1507

38W |  Ø120mm

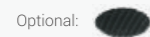
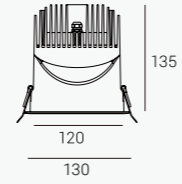

Linan



Linan upgrade

After several years, we have upgraded the Linan series as a whole through market information collection and customization requirements, as well as the customer's requirements for the performance and material properties of some products used by various usage scenarios.

The cut hole made in the upgraded version are 55, 65, 75, 95, 120, 150 square single head and double head, Round beam and Anti-glare kit. Among them, 65 and 75 have made Round beam(Metal seamless), and 75 openings also have reflector cup (H: 102mm) and lenses (H: 92mm).

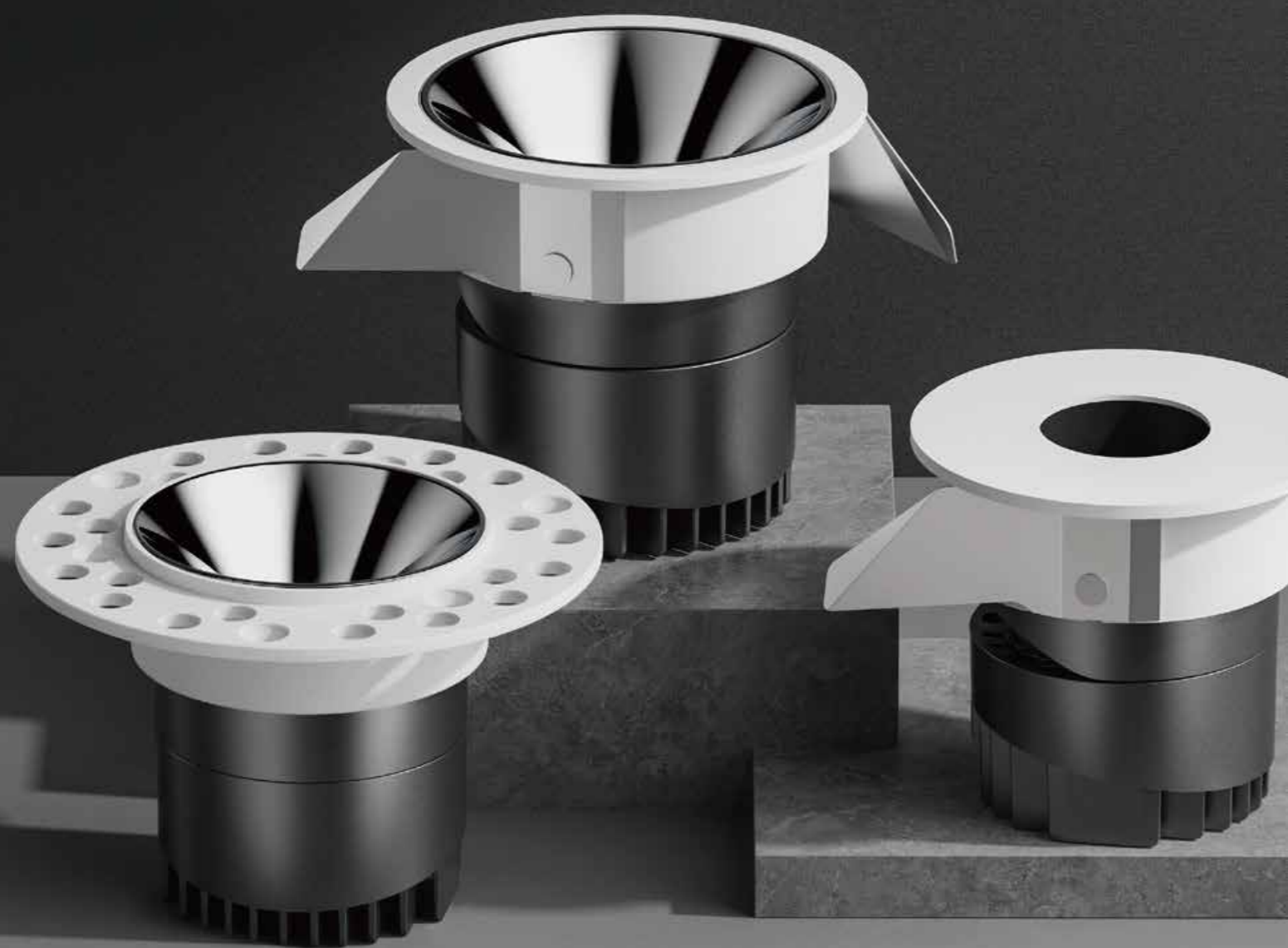

First Generation:



Second Generation:



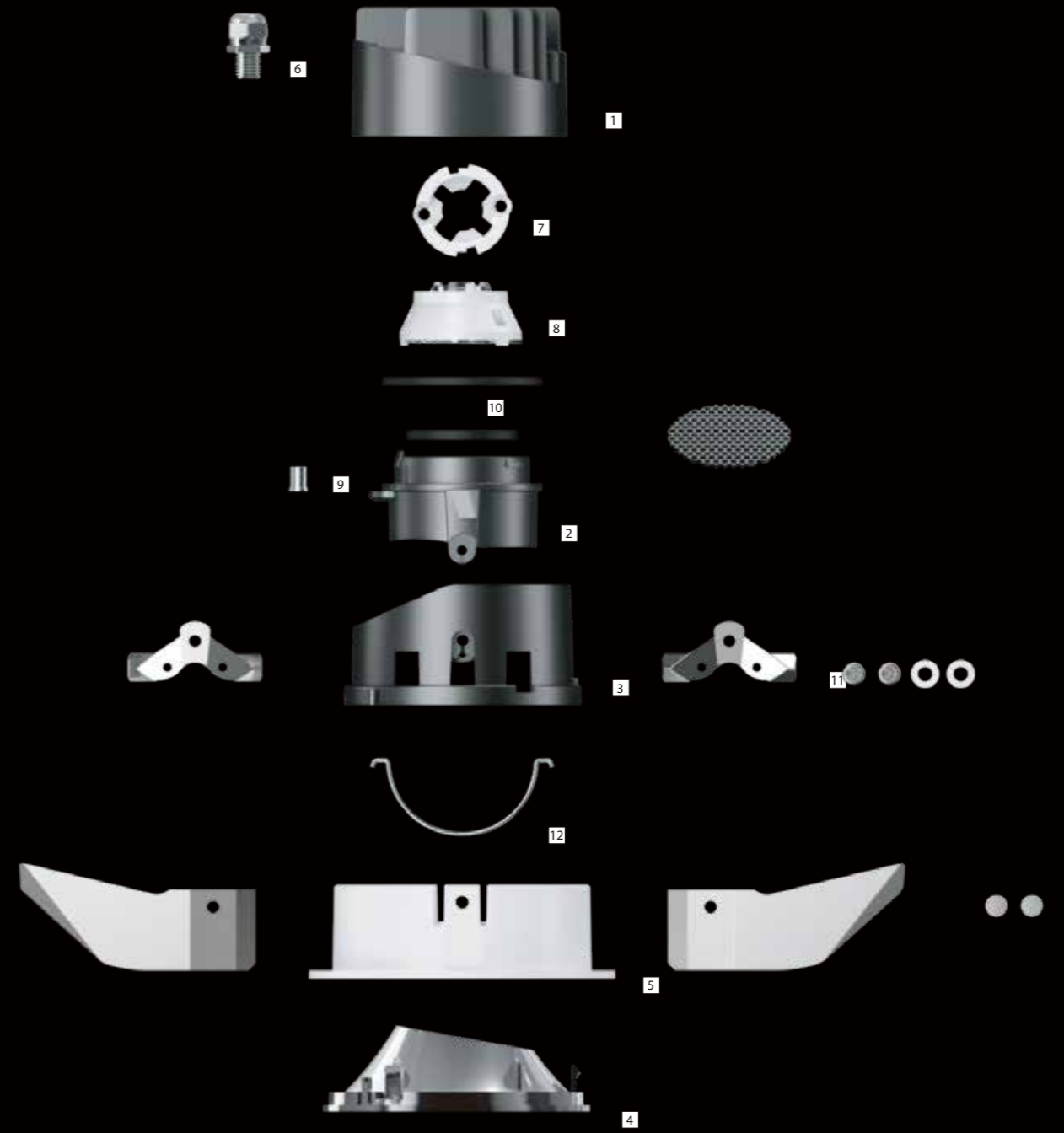
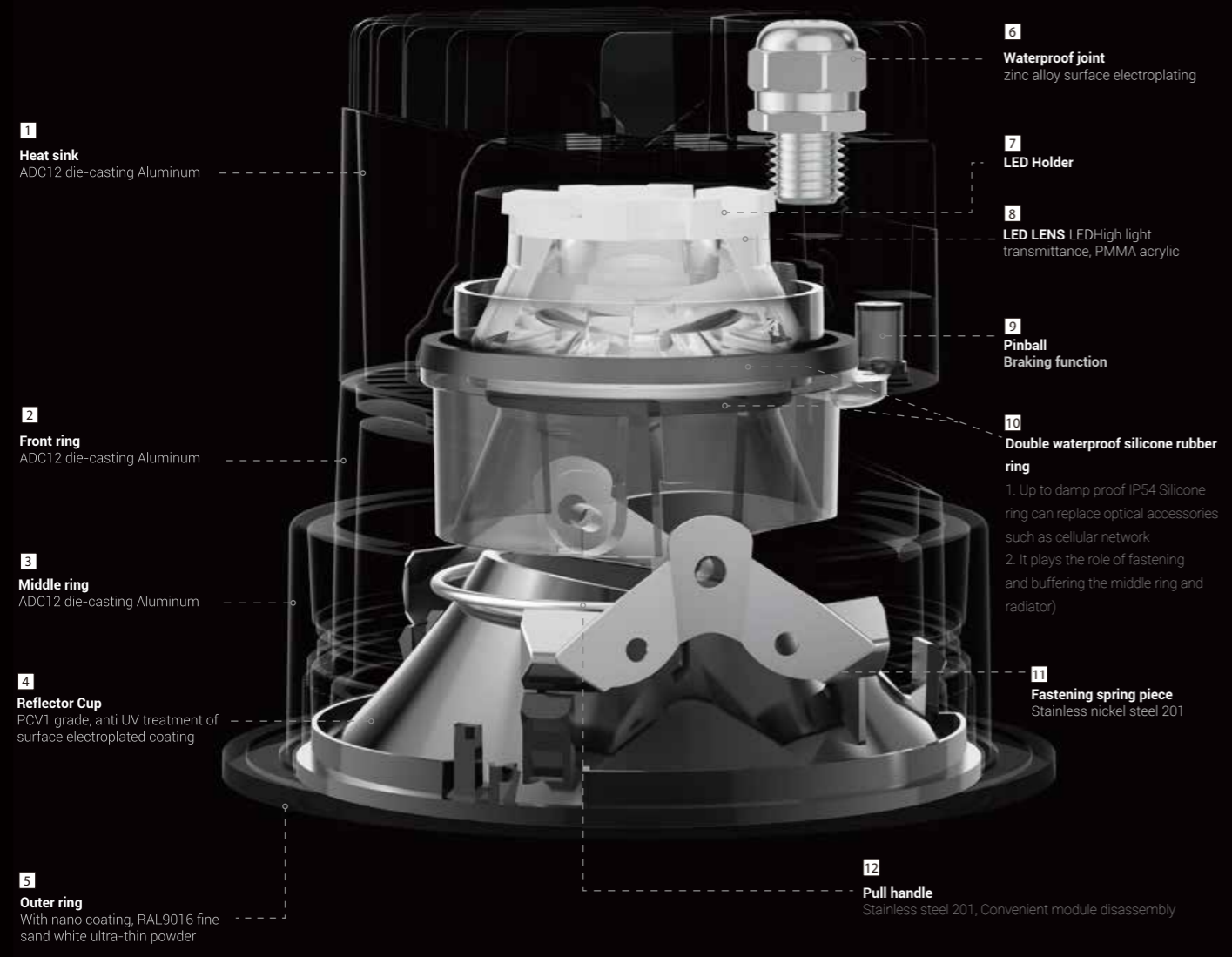

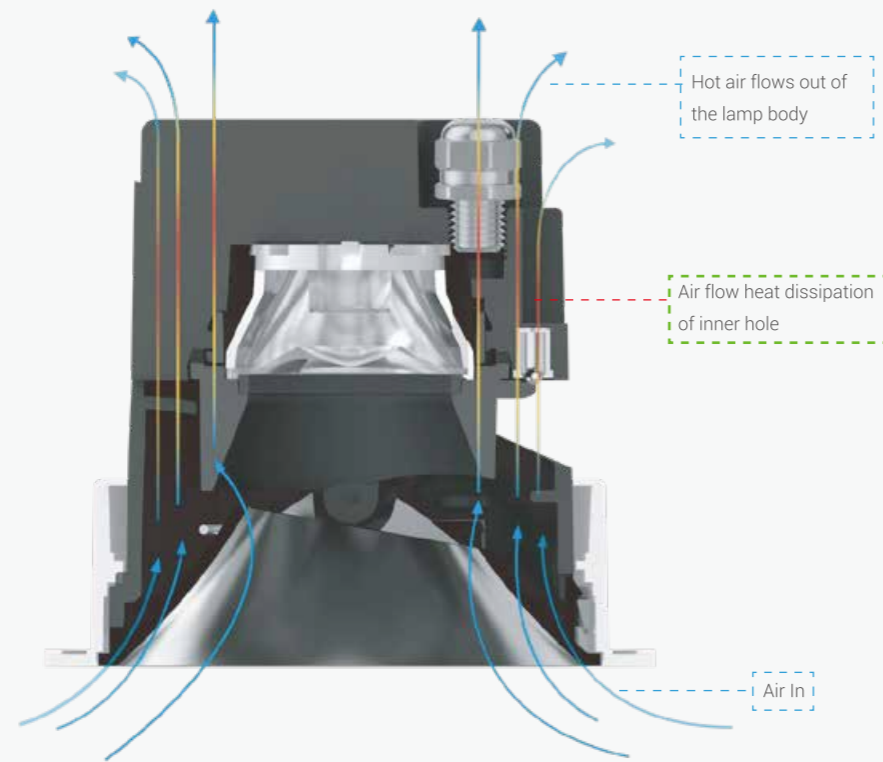

Note: The red part is the adjustment middle ring, and light leakage prevention design show in the schematic diagram

Radiator simulation

Die-casting aluminum heat dissipation structure, the heat is derived from the inner hole of the heatsink, and when the air flow rises from the inner hole, the heat is exported with the air.

Light leakage prevention design

Through the full surrounding middle ring design, The direct lighting or adjustable light of the lamp is completely leakage prevention design, and effectively block the dazzling stray light and residual light

Fool-proof design

Snap the reflector cover into the marked hole, Effectively fool-proof

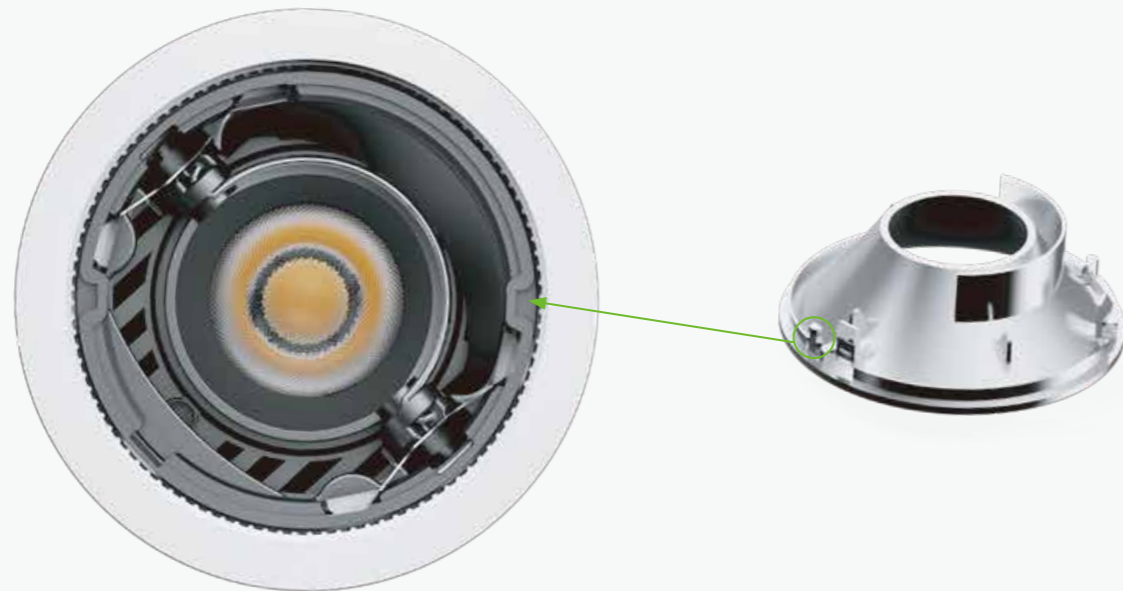

0~30°

Stepless regulation 0~30° at any angle

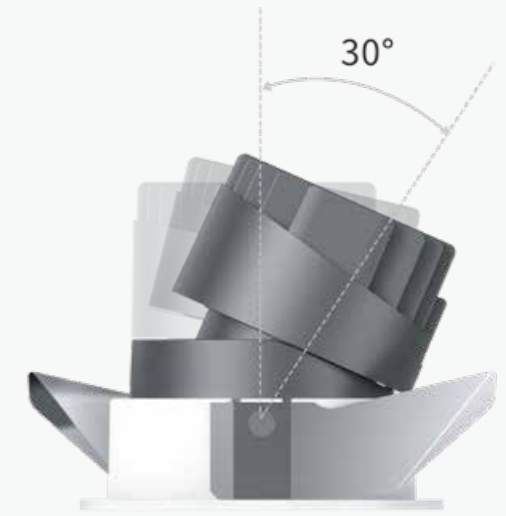

Horizontal rotation of 355°

Horizontal rotation of 355°, with positioning point, damping to Fool-proof and prevent winding.

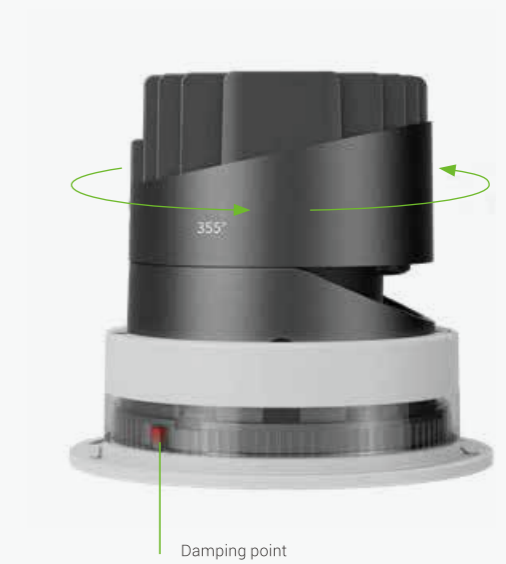

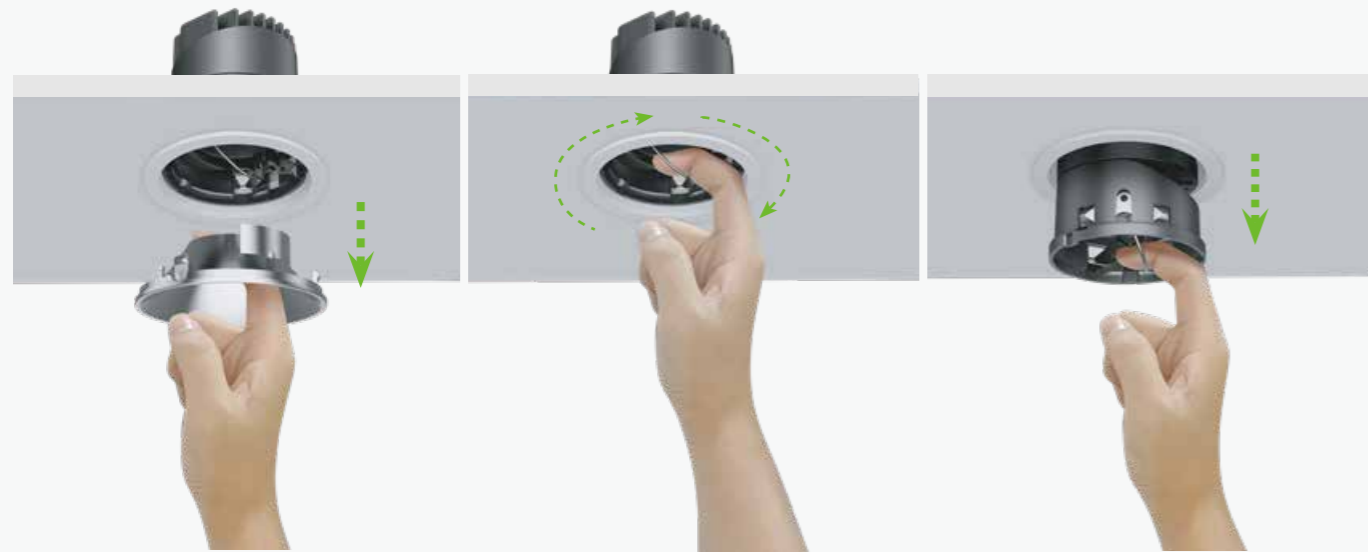

1

Take out reflector cover

2

Rotatable adjustment

3

Pull out the module

Unique Pull handle design

Pull ring design, convenient for tank adjustment and disassembly

Double-layer shockproof role

After rotating the front ring to the correct position, the metal pinball will automatically pop out into the groove, fasten the heatsink, and play a double-layer shockproof role with the silicone ring.

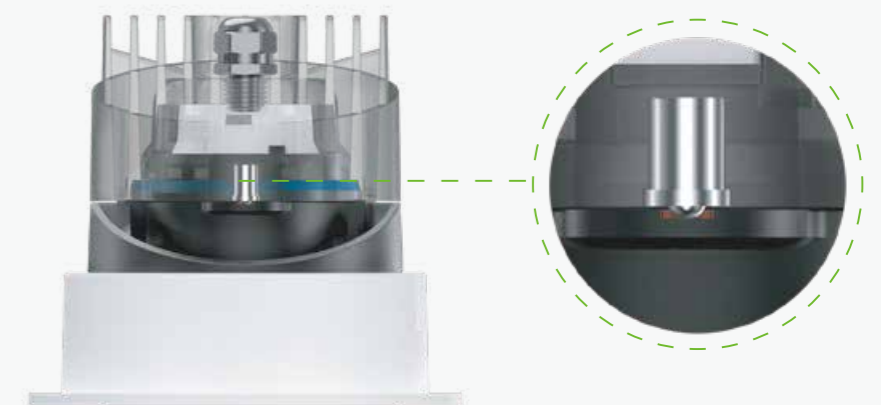
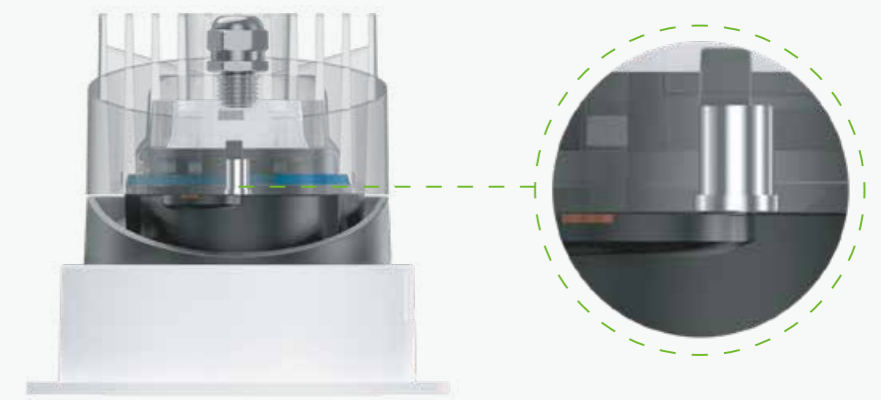

Note: The red part indicates the groove, and the blue part indicates the silicone ring

Spring

A variety of springs are available for quick installation, suitable for various ceiling thicknesses



Frame

Frame: Frame with edge, Frame trimless, and Round beam (Metal seamless)



Integrated narrow edge

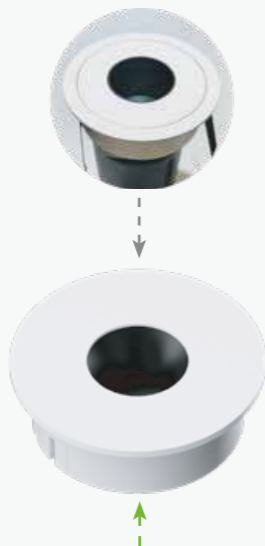

Previous generation Round beam frame with gaps

Round beam frame (Metal seamless) eliminating the common frame with gaps



Integrated Trimless

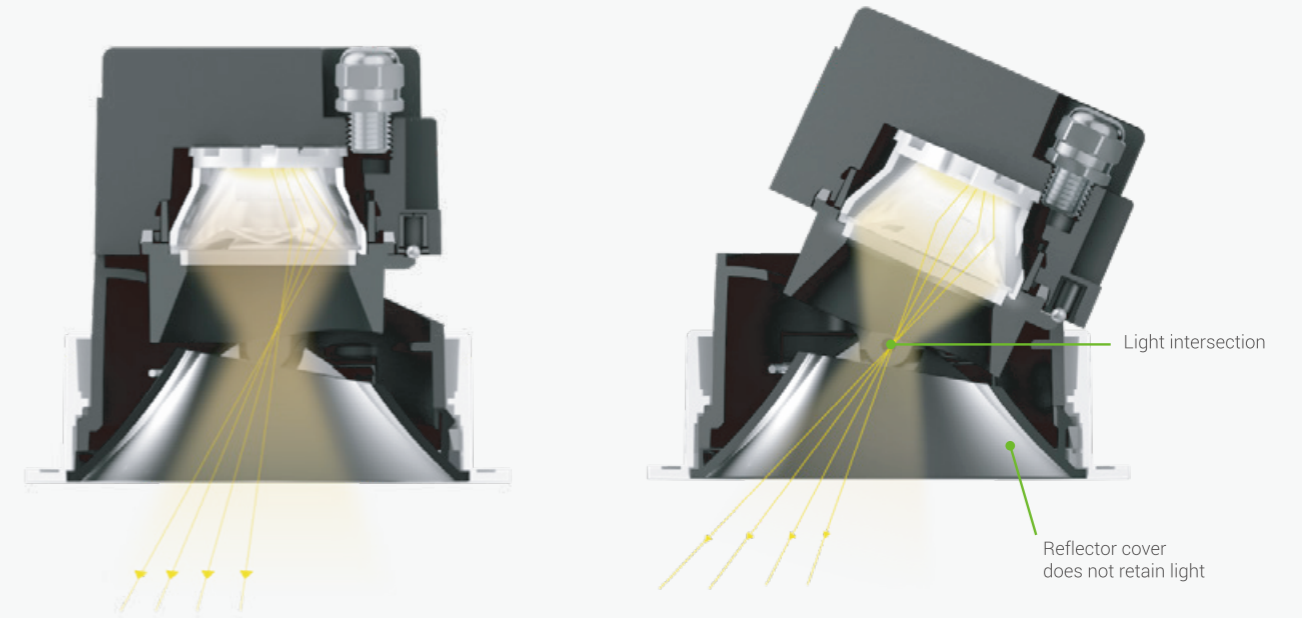

PMMA high luminous rate, Ribbed structure lens

The ribbed structure design is adopted, with its own anti glare effect, so that the light is interwoven at the center of the upper end of the reflector, effectively reducing stray light, and the light spot transition is even, more soft and comfortable



Linan upgrade

Optical fitting On demand transformation

Five optical Fitting are optional, which can realize the change of spot shape, full lamp UGR and other technical parameters to meet the lighting needs of different scenes

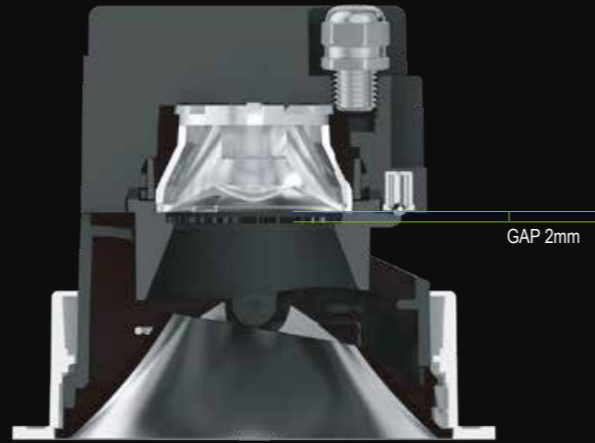

BVT optical film



Clear glass sheet



Stretching optical PC



Honeycomb



Anti dazzle ring
(Secondary facula removal at small beam angle)

SPOTLIGHT

No stray light, Round spot

Secondary light spot, pure and clear,
uniform light spot transition, more soft and comfortable

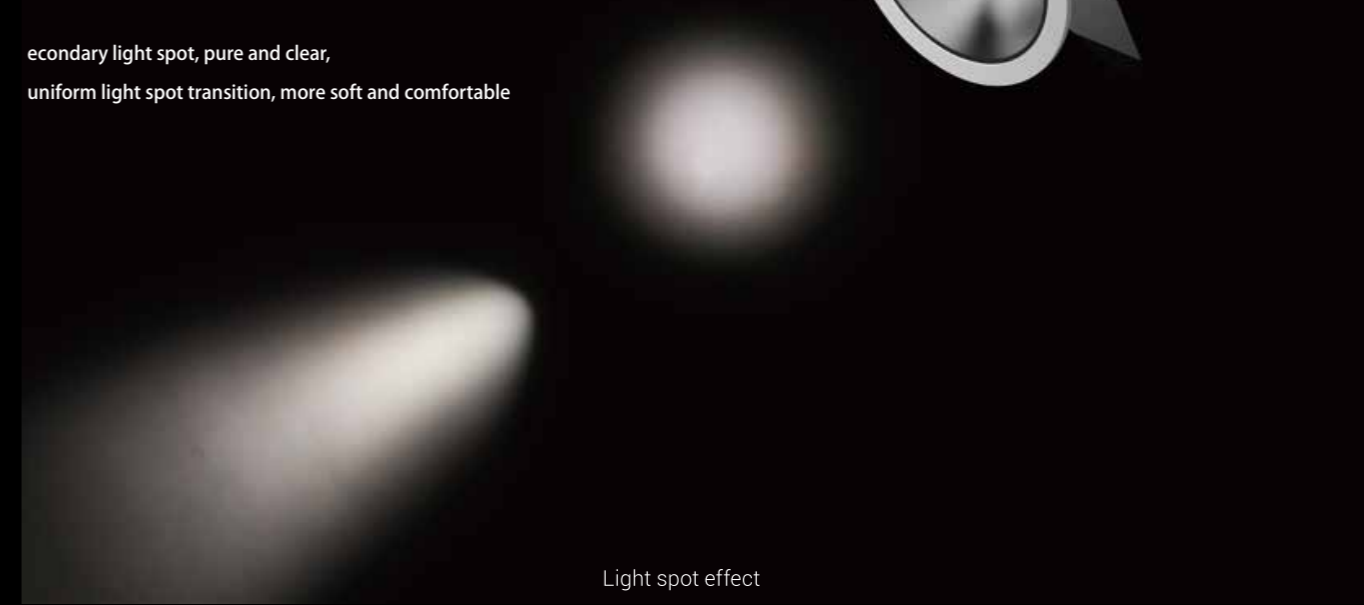

Light spot effect

8°	12°	15°	24°	36°	55°

Linan Upgrade

Linan upgrade - 8W

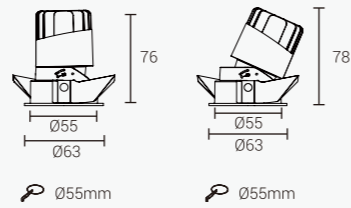
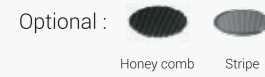

XQ-100301E55 / XQ-100302E55 / XQ-100303E55

Model Code	XQ-100301E55	XQ-100302E55	XQ-100303E55
Power	8W	8W	8W
Cut out	Φ55mm	Φ55mm	Φ55mm
Light Source	CREE	CREE	CREE
Size(DxH)	Φ63x76mm	Φ63x78mm	Φ63x76mm

UGR	<13	<13	<13
CRI	≥80/≥90	≥80/≥90	≥80/≥90
Beam angle	15°/24°/36°/55°	15°/24°/36°/55°	15°/24°/36°/55°

CCT	2700K/3000K/4000K/5000K	2700K/3000K/4000K/5000K	2700K/3000K/4000K/5000K
Life time	50000 h	50000 h	50000 h
IP	IP20	IP20	IP20

Linan Upgrade

Linan upgrade - 8W

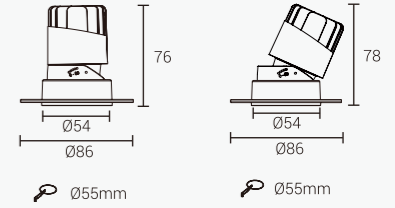
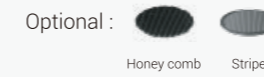
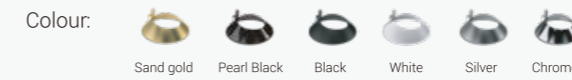

XQ-100301YT55 / XQ-100302YT55 / XQ-100303YT55

Model Code	XQ-100301YT55	XQ-100302YT55	XQ-100303YT55
Power	8W	8W	8W
Cut out	Φ55mm	Φ55mm	Φ55mm
Light Source	CREE	CREE	CREE
Size(DxH)	Φ86xH76mm	Φ86xH78mm	Φ86xH76mm

UGR	<13	<13	<13
CRI	≥80/≥90	≥80/≥90	≥80/≥90
Beam angle	15°/24°/36°/55°	15°/24°/36°/55°	15°/24°/36°/55°



CCT	2700K/3000K/4000K/5000K	2700K/3000K/4000K/5000K	2700K/3000K/4000K/5000K
Life time	50000 h	50000 h	50000 h
IP	IP20	IP20	IP20

Linan Upgrade

Linan upgrade - 8/16/24W



Colour:      

Optional :  

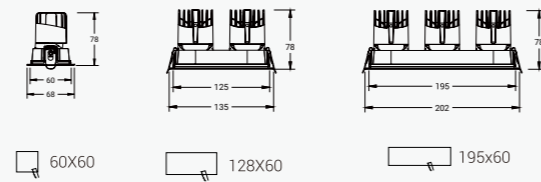







XQ- 100302P55 / XQ- 100302P55-2 / XQ- 100302P55-3



Model Code	XQ- 100302P55	XQ- 100302P55-2	XQ- 100302P55-3
Power	8W	2X8W	3X8W
Cut out	60X60mm	128X60mm	195X60mm
Light Source	CREE	CREE	CREE
Size(DxH)	68X68X78mm	135X68X78mm	202X68X78mm
UGR	<13	<13	<13
CRI	≥80/≥90	≥80/≥90	≥80/≥90
Beam angle	15°/24°/36°/55°	15°/24°/36°/55°	15°/24°/36°/55°
CCT	2700K/3000K/4000K/5000K	2700K/3000K/4000K/5000K	2700K/3000K/4000K/5000K
Life time	50000 h	50000 h	50000 h
IP	IP20	IP20	IP20

Linan Upgrade

Linan upgrade - 8W



Colour:      

Optional :  

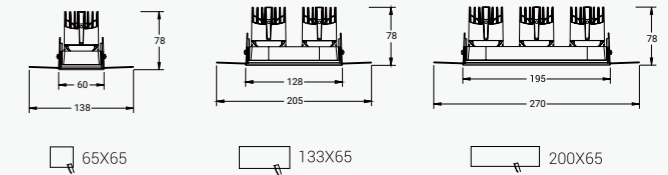

XQ- 100302PT55 / XQ- 100302PT55- 2 / XQ- 100302PT55- 3

Model Code	XQ- 100302PT55	XQ- 100302PT55-2	XQ- 100302PT55-3
Power	8W	2X8W	3X8W
Cut out	65X65mm	133X65mm	200X65mm
Light Source	CREE	CREE	CREE
Size(DxH)	138X60X78mm	205X60X78mm	272X60X78mm
UGR	<13	<13	<13
CRI	≥80/≥90	≥80/≥90	≥80/≥90
Beam angle	15°/24°/36°/55°	15°/24°/36°/55°	15°/24°/36°/55°
CCT	2700K/3000K/4000K/5000K	2700K/3000K/4000K/5000K	2700K/3000K/4000K/5000K
Life time	50000 h	50000 h	50000 h
IP	IP20	IP20	IP20

Linan Upgrade

Linan upgrade - 10W

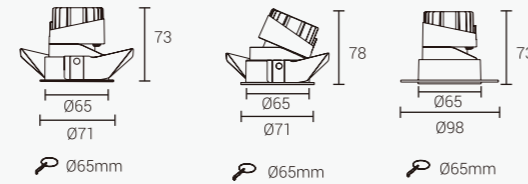
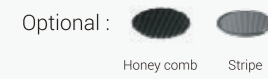
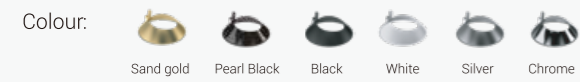

XQ-100301E65S-JS / XQ-100302E65S-JS / XQ-100303E65S-JS / XQ-100302YT65S-JS / XQ-100303YT65S-JS

Model Code	XQ-100301E65S-JS	XQ-100302E65S-JS	XQ-100303E65S-JS	XQ-100302YT65S-JS	XQ-100303YT65S-JS
Power	10W	10W	10W	10W	10W
Cut out	Φ65mm	Φ65mm	Φ65mm	Φ65mm	Φ65mm
Light Source	CREE	CREE	CREE	CREE	CREE
Size(DxH)	Φ71x73mm	Φ71x78mm	Φ71x73mm	Φ98x78mm	Φ98x73mm
UGR	<13	<13	<13	<13	<13
CRI	≥80/≥90	≥80/≥90	≥80/≥90	≥80/≥90	≥80/≥90
Beam angle	10°/15°/24°/36°/55°	10°/15°/24°/36°/55°	10°/15°/24°/36°/55°	10°/15°/24°/36°/55°	10°/15°/24°/36°/55°
CCT	2700K/3000K/4000K/5000K	2700K/3000K/4000K/5000K	2700K/3000K/4000K/5000K	2700K/3000K/4000K/5000K	2700K/3000K/4000K/5000K
Life time	50000 h	50000 h	50000 h	50000 h	50000 h
IP	IP54	IP54	IP54	IP54	IP54

Linan Upgrade

Linan upgrade - 12/24W

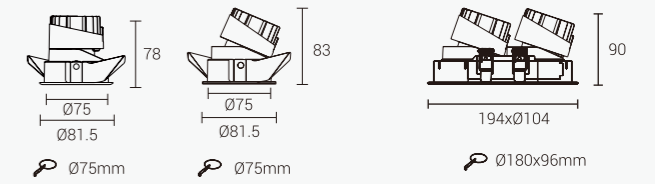
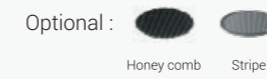
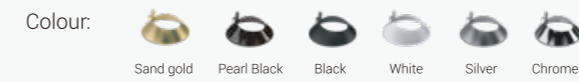

XQ-100301E75S-JS / XQ-100302E75S-JS / XQ-100303E75S-JS / XQ-100302E75S-2-JS

Model Code	XQ-100301E75S-JS	XQ-100302E75S-JS	XQ-100303E75S-JS	XQ-100302E75S-2-JS
Power	12W	12W	12W	2x12W
Cut out	Φ75mm	Φ75mm	Φ75mm	Ø180x96mm
Light Source	CREE	CREE	CREE	CREE
Size(DxH)	Φ81.5x78mm	Φ81.5x83mm	Φ81.5x78mm	194x104x90mm
UGR	<13	<13	<13	<13
CRI	≥80/≥90	≥80/≥90	≥80/≥90	≥80/≥90
Beam angle	10°/15°/24°/36°/50°	10°/15°/24°/36°/50°	10°/15°/24°/36°/50°	10°/15°/24°/36°/50°
CCT	2700K/3000K/4000K/5000K	2700K/3000K/4000K/5000K	2700K/3000K/4000K/5000K	2700K/3000K/4000K/5000K
Life time	50000 h	50000 h	50000 h	50000 h
IP	IP54	IP54	IP54	IP54

Linan Upgrade

Linan upgrade - 12W

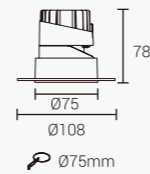
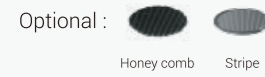

XQ-100301YT75S-JS / XQ-100302YT75S-JS / XQ-100303YT75S-JS

Model Code	XQ-100301YT75S-JS	XQ-100303YT75S-JS	XQ-100303YT75S-JS
Power	12W	12W	12W
Cut out	Φ75mm	Φ75mm	Φ75mm
Light Source	CREE	CREE	CREE
Size(DxH)	Φ108X78mm	Φ108X78mm	Φ108X78mm
UGR	<13	<13	<13
CRI	≥80/≥90	≥80/≥90	≥80/≥90
Beam angle	10°/15°/ 24°/ 36°/ 50°	10°/15°/ 24°/ 36°/ 50°	10°/15°/ 24°/ 36°/ 50°
CCT	2700K/3000K/4000K/5000K	2700K/3000K/4000K/5000K	2700K/3000K/4000K/5000K
Life time	50000 h	50000 h	50000 h
IP	IP54	IP54	IP54

Linan Upgrade

Linan upgrade - 12W

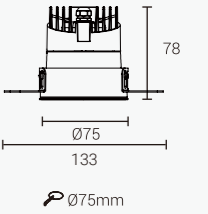
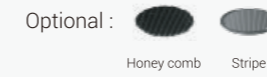
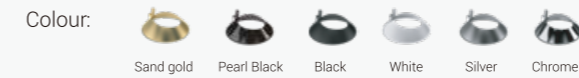



XQ-100301T75S-JS / XQ-100302T75S-JS / XQ-100303T75S-JS

Model Code	XQ-100301T75S-JS	XQ-100303T75S-JS	XQ-100303T75S-JS
Power	12W	12W	12W
Cut out	Φ75mm	Φ75mm	Φ75mm
Light Source	CREE	CREE	CREE
Size(DxH)	133X78mm	133X78mm	133X78mm
UGR	<13	<13	<13
CRI	≥80/≥90	≥80/≥90	≥80/≥90
Beam angle	10°/15°/ 24°/ 36°/ 50°	10°/15°/ 24°/ 36°/ 50°	10°/15°/ 24°/ 36°/ 50°
CCT	2700K/3000K/4000K/5000K	2700K/3000K/4000K/5000K	2700K/3000K/4000K/5000K
Life time	50000 h	50000 h	50000 h
IP	IP54	IP54	IP54

Linan Upgrade

Linan upgrade - 12/24W



Colour:      

Optional:  

Honey comb Stripe

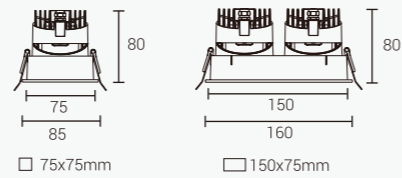



XQ- 100302P75S-JS / XQ-100302P75-2-JS

Model Code	XQ-100302P75S-JS	XQ-100302P75S-2-JS
Power	12W	2X12W
Cut out	75x75mm	150X75mm
Light Source	CREE	CREE
Size(DxH)	85x85X80mm	160X85X80mm
UGR	<13	<13
CRI	≥80/≥90	≥80/≥90
Beam angle	10°/15°/ 24°/ 36°/ 50°	10°/15°/ 24°/ 36°/ 50°
CCT	2700K/3000K/4000K/5000K	2700K/3000K/4000K/5000K
Life time	50000 h	50000 h
IP	IP54	IP54

Linan Upgrade

Linan upgrade - 12/24W



Colour:      

Optional:  

Honey comb Stripe

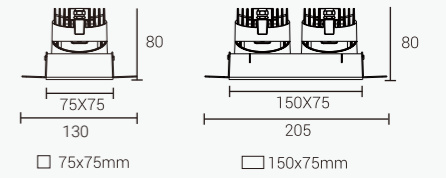

XQ- 100302TP75S-JS / XQ-100302TP75-2-JS

Model Code	XQ-100302TP75S-JS	XQ-100302TP75S-2-JS
Power	12W	2X12W
Cut out	75x75mm	150X75mm
Light Source	CREE	CREE
Size(DxH)	130x75xH80mm	205X75X80mm
UGR	<13	<13
CRI	≥80/≥90	≥80/≥90
Beam angle	10°/15°/ 24°/ 36°/ 50°	10°/15°/ 24°/ 36°/ 50°
CCT	2700K/3000K/4000K/5000K	2700K/3000K/4000K/5000K
Life time	50000 h	50000 h
IP	IP54	IP54



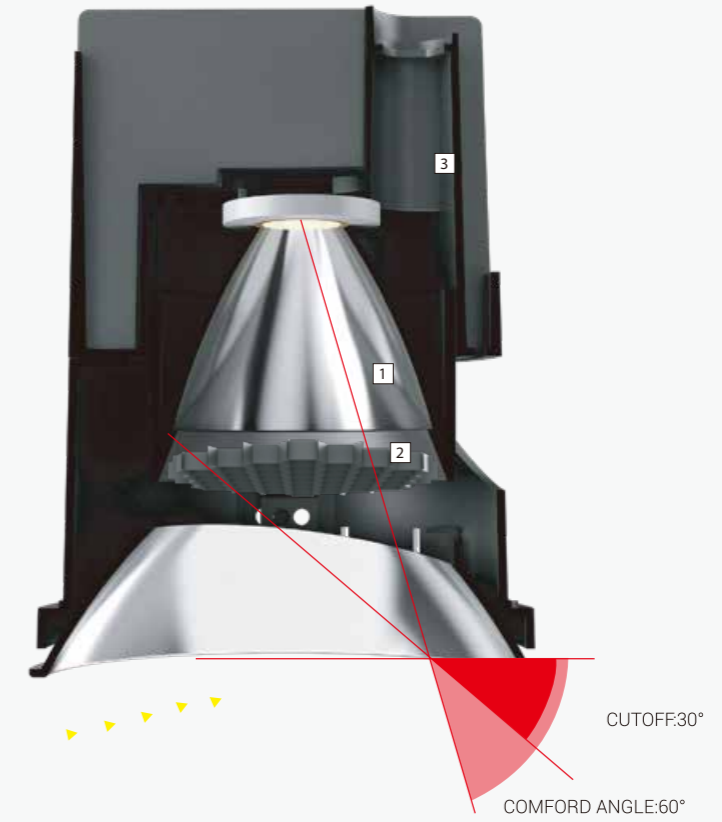

- Reflector cover 6 colors are optional to meet the needs of different occasions.
- Family design - full range of spotlights, different needs and different choices, face rings can choose a variety of styles.
- Suitable for high-end hotels, villas clubs, high-end residential, for your business life to provide a more comfortable and healthy lighting space.

Dark light technology

Deep reflection cup, UGR < 16, lengthen the distance between light source and light outlet, improve the anti-glare performance. The light is filtered by the reflecting cup and the anti-glare honeycomb to effectively reduce the excess light beam.

- 1 Deep reflective cup, providing anti-glare performance.
- 2 Honeycomb Mesh, Effectively Prevent Excess Astigmatism.
- 3 Die-casting aluminium radiator with higher heat dissipation efficiency.

Linan



Reflectors in different color



Sand gold

White

Chrome

Silver

Pearl Black

Black

SPOTLIGHT

Modularization Design



Linan

Infinite splicing of square boxes

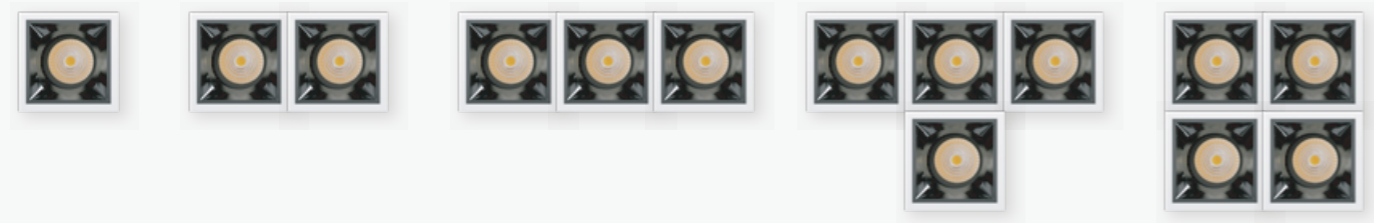

Free combination

Freely stitching like Tetris, providing enough illumination for high-rise spaces
Square frame provides flexible lighting.

MR16-Modularization Design



SPOTLIGHT



Comply MR16 Matching

Can be combined with different light source modules, different combination.



Family design

According to lighting effect and facial rings, various styles and light effects can be selected. Each kind of facial ring has its own unique light effect.

Multiple Installation Structures

Reasonable installation structure can keep smallpox simple, natural and visual consistency.



- 1 75mm aperture specifications have lens options, the whole lamp height is smaller, more suitable for low ceiling space scenarios.
- 2 Independently designed product appearance, Fastener modular structure, easy installation and maintenance.
- 3 Reflector cover is precisely designed, electroplated and nano-sprayed. It has high reflection efficiency and provides comfortable light with high efficiency.



Linan



2-30mm

Quickly tighten the screws for easy installation
Suitable for all ceiling thicknesses up to 30mm.

Luminous efficiency

The lamp head can be rotated freely in all directions.
Let the light move with the heart and maximize the value of light.



SPOTLIGHT

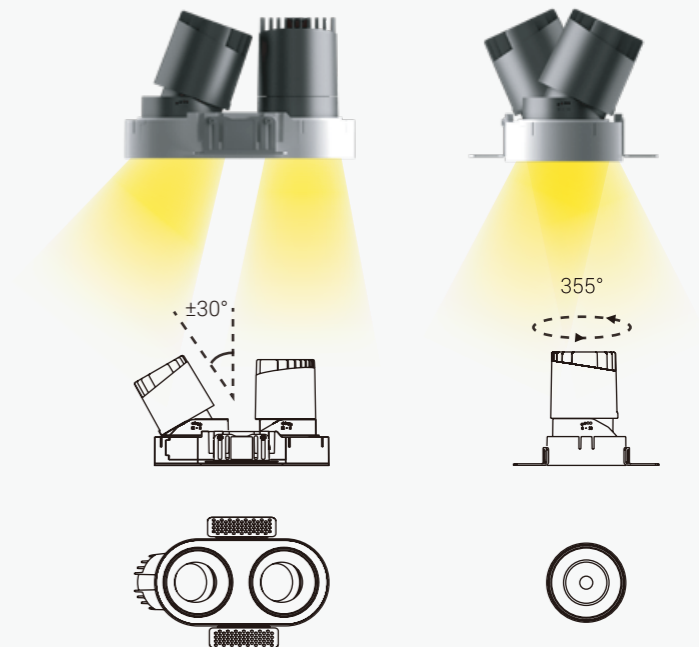

Whatever you want

The new face frame adapts to various series



Free combination

Free collocation like building blocks, providing enough choices for more scenes
Multi head face box provides more matching ways.



Whatever you want

Whatever you want - match freely

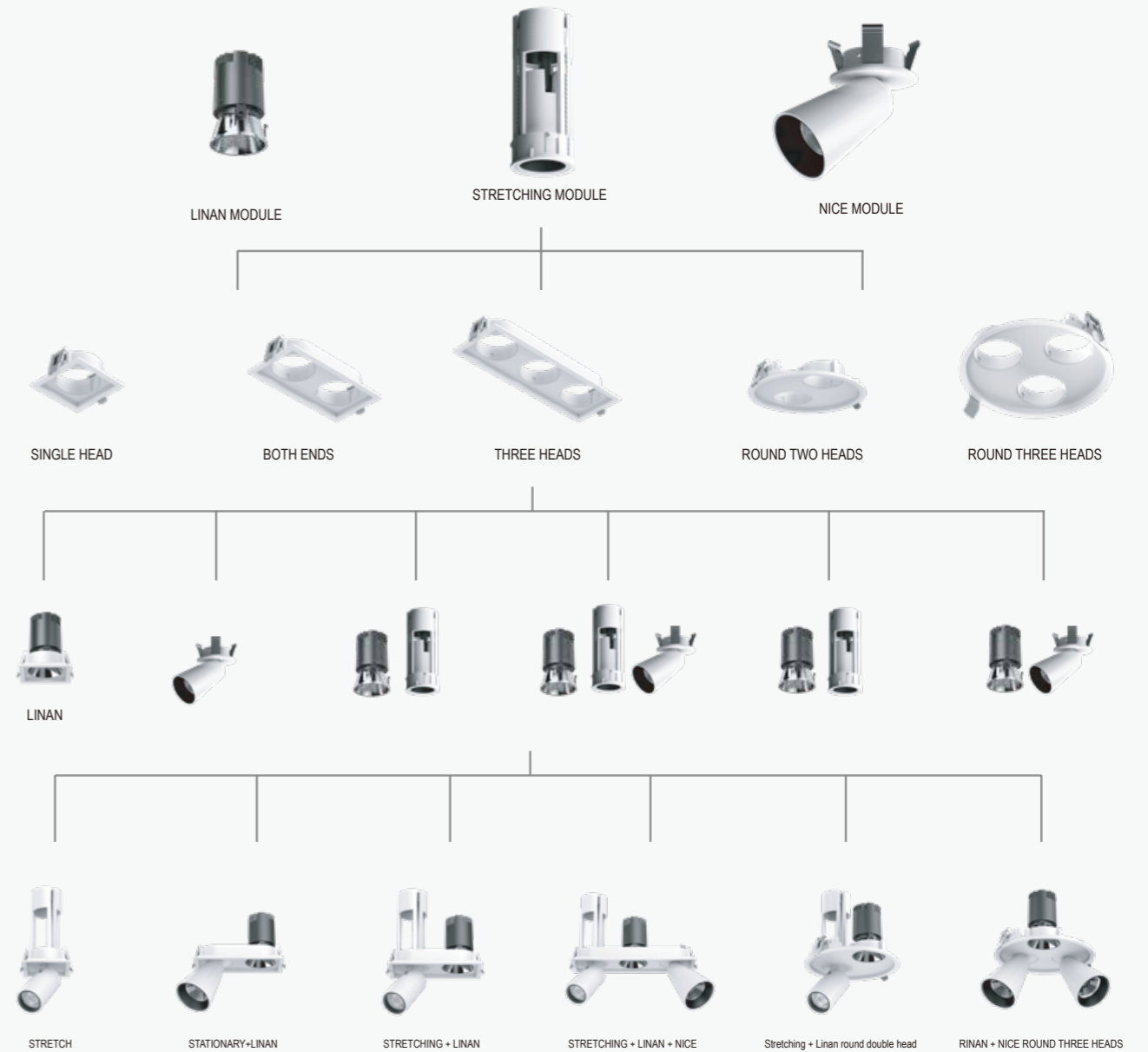

Linan

MR16

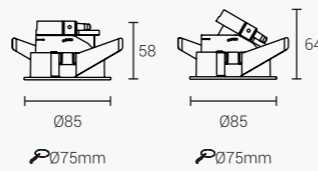

XQ-100302E75 MR16 / XQ-100303E75 MR16 / XQ-100304E75 MR16 / XQ-100305E75 MR16

Model Code	XQ-100302E75 MR16	XQ-100303E75 MR16	XQ-100304E75 MR16	XQ-100305E75 MR16
Power	/	/	/	/
Cut out	Φ75mm	Φ75mm	Φ75mm	Φ75mm
Light Source	CREE	CREE	CREE	CREE
Size(DxH)	Φ85x64mm	Φ85x58mm	Φ85x64mm	Φ85x64mm

Linan

MR16

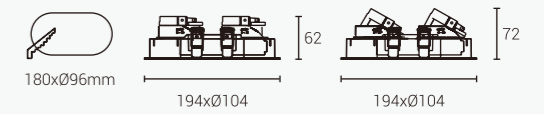
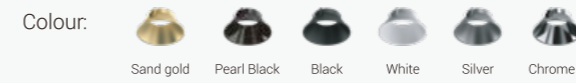

XQ-100302E75-2 MR16 / XQ-100303E75-2 MR16 / XQ-100304E75-2 MR16 / XQ-100301E75-2 MR16

Model Code	XQ-100302E75-2 MR16	XQ-100303E75-2 MR16	XQ-100304E75-2 MR16	XQ-100301E75-2 MR16
Power	/	/	/	/
Cut out	180x096mm	180x096mm	180x096mm	180x096mm
Light Source	CREE	CREE	CREE	CREE
Size(DxH)	194xΦ104x62mm	194xΦ104x62mm	194xΦ104x72mm	194xΦ104x72mm

Linan

MR16

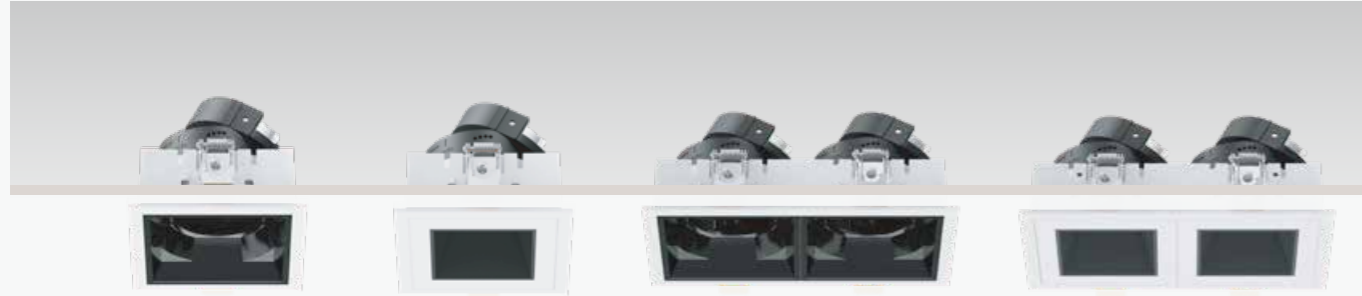

Colour:

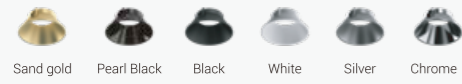

Optional:

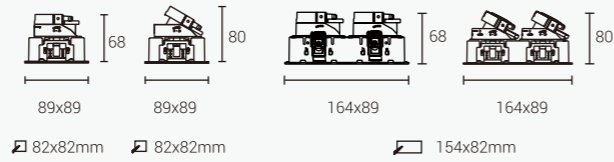

XQ-100302T82 MR16 / XQ-100303T82 MR16 / XQ-100302E82-2 MR16 / XQ-100303E82-2 MR16

Model Code	XQ-100302E82 MR16	XQ-100303E82 MR16	XQ-100302E82-2 MR16	XQ-100303E82-2 MR16
Power	/	/	/	/
Cut out	82x82mm	82x82mm	154x82mm	154x82mm
Light Source	CREE	CREE	CREE	CREE
Size(DxH)	89x89x68mm	89x89x80mm	164x89x68mm	164x89x80mm

Linan

MR16

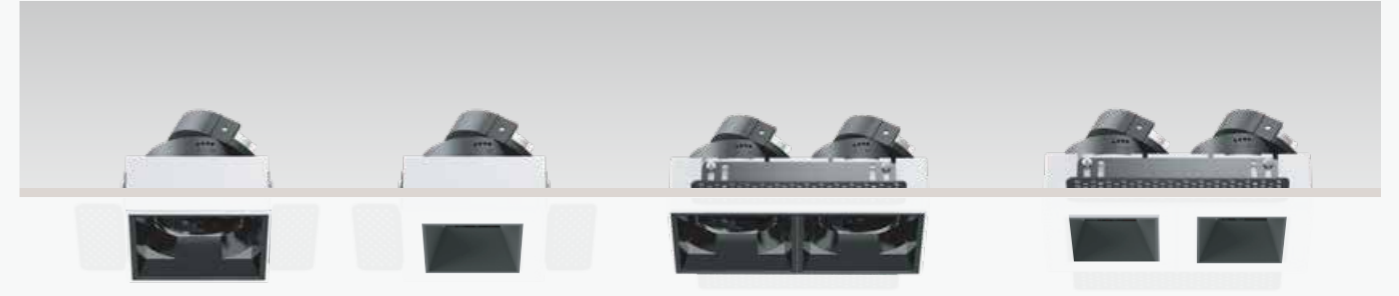

Colour:

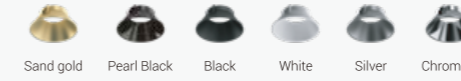

Optional:

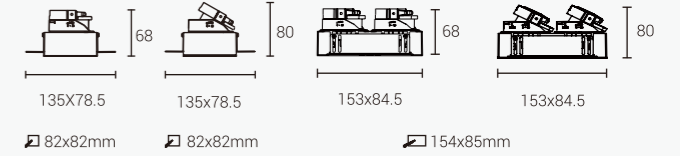

XQ-100302T82 MR16 / XQ-100303T82 MR16 / XQ-100302T82-2 MR16 / XQ-100303T82-2 MR16

Model Code	XQ-100302T82 MR16	XQ-100303T82 MR16	XQ-100302T82-2 MR16	XQ-100303T82-2 MR16
Power	/	/	/	/
Cut out	82x79mm	82x79mm	154x85mm	154x85mm
Light Source	CREE	CREE	CREE	CREE
Size(DxH)	135x78.5x68mm	135x78.5x80mm	153x84.5x68mm	153x84.5x80mm

Linan

MR16

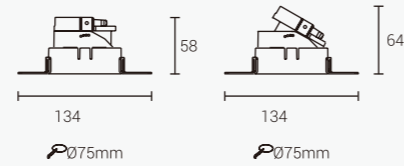
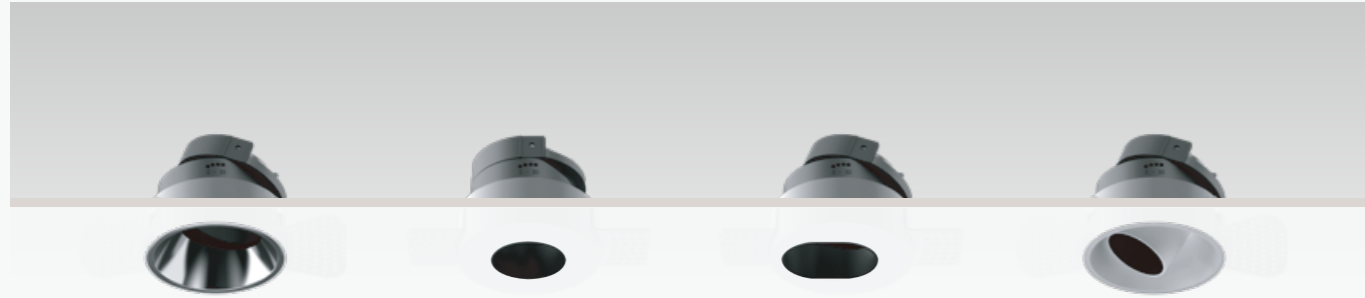

XQ-100302T75 MR16 / XQ-100303T75 MR16 / XQ-100304T75 MR16 / XQ-100305T75 MR16

Model Code	XQ-100302T75 MR16	XQ-100303T75 MR16	XQ-100304T75 MR16	XQ-100305T75 MR16
Power	/	/	/	/
Cut out	$\varnothing 75\text{mm}$	$\varnothing 75\text{mm}$	$\varnothing 75\text{mm}$	$\varnothing 75\text{mm}$
Light Source	CREE	CREE	CREE	CREE
Size(DxH)	134x64mm	134x58mm	$\varnothing 134 \times 64\text{mm}$	$\varnothing 134 \times 64\text{mm}$

Linan

MR16

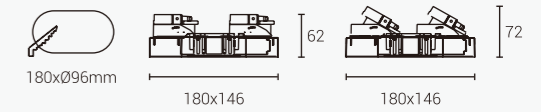
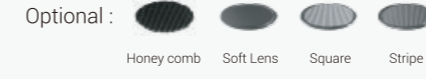
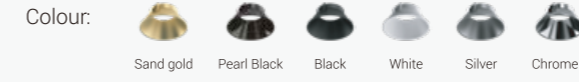

XQ-100302T75-2 MR16 / XQ-100303T75-2 MR16 / XQ-100304T75-2 MR16 / XQ-100305T75-2 MR16

Model Code	XQ-100302T75-2 MR16	XQ-100303T75-2 MR16	XQ-100304T75-2 MR16	XQ-100305T75-2 MR16
Power	/	/	/	/
Cut out	180x $\varnothing 96\text{mm}$	180x $\varnothing 96\text{mm}$	180x $\varnothing 96\text{mm}$	180x $\varnothing 96\text{mm}$
Light Source	CREE	CREE	CREE	CREE
Size(DxH)	180x146x62mm	180x146x62mm	180x146x72mm	180x146x72mm

Linan

MR16

MR0710



MR1215



MR0711



MR0710 / MR1215 / MR0711

Model Code	MR0710	MR1215	MR0711
Power	10W	15W	10W
Cut out	/	/	/
Light Source	CREE	CREE	CREE
Size(DxH)	Φ50x71mm	Φ50x80mm	Φ49x60.5mm
Beam angle	20°/40°	20°/40°	15°/24°/36°/50°













Indoor Project Lighting

Linan

Linan - 6W



- Colour:  Sand gold  Pearl Black  Black  White  Silver  Chrome
- Optional:  Honey comb  Stripe

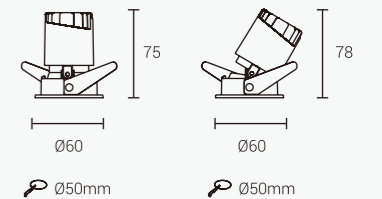

XQ-100301E50 / XQ-100302E50 / XQ-100303E50 / XQ-100304E50

Model Code	XQ-100301E50	XQ-100302E50	XQ-100303E50	XQ-100304E50
Power	6W	6W	6W	6W
Cut out	Φ50mm	Φ50mm	Φ50mm	Φ50mm
Light Source	CREE	CREE	CREE	CREE
Size(DxH)	Φ60x75mm	Φ60x78mm	Φ60x75mm	Φ60x78mm
UGR	<19	<19	<19	<19
CRI	≥80/≥90	≥80/≥90	≥80/≥90	≥80/≥90
Beam angle	10°/15°/24°/38°	10°/15°/24°/38°	10°/15°/24°/38°	10°/15°/24°/38°
CCT	2700K/3000K/4000K/5000K	2700K/3000K/4000K/5000K	2700K/3000K/4000K/5000K	2700K/3000K/4000K/5000K
Life time	50000 h	50000 h	50000 h	50000 h
IP	IP20	IP20	IP20	IP20

Linan

Linan - 6W

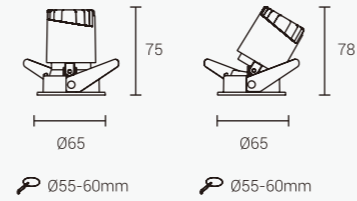
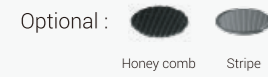

XQ-100301E55-60 / XQ-100302E55-60 / XQ-100303E55-60 / XQ-100304E55-60

Model Code	XQ-100301E55-60	XQ-100302E55-60	XQ-100303E55-60	XQ-100304E55-60
Power	6W	6W	6W	6W
Cut out	Φ55-60mm	Φ55-60mm	Φ55-60mm	Φ55-60mm
Light Source	CREE	CREE	CREE	CREE
Size(DxH)	65x75mm	65x78mm	65x75mm	65x78mm
UGR	<19	<19	<19	<19
CRI	≥80/≥90	≥80/≥90	≥80/≥90	≥80/≥90
Beam angle	10°/15°/24°/38°	10°/15°/24°/38°	10°/15°/24°/38°	10°/15°/24°/38°
CCT	2700K/3000K/4000K/5000K	2700K/3000K/4000K/5000K	2700K/3000K/4000K/5000K	2700K/3000K/4000K/5000K
Life time	50000 h	50000 h	50000 h	50000 h
IP	IP20	IP20	IP20	IP20

Linan

Linan - 8W

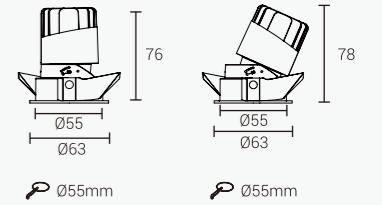
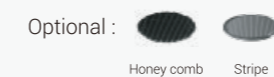

XQ-100301E55 / XQ-100302E55 / XQ-100303E55

Model Code	XQ-100301E55	XQ-100302E55	XQ-100303E55
Power	8W	8W	8W
Cut out	Φ55mm	Φ55mm	Φ55mm
Light Source	CREE	CREE	CREE
Size(DxH)	Φ63x76mm	Φ63x78mm	Φ63x76mm
UGR	<13	<13	<13
CRI	≥80/≥90	≥80/≥90	≥80/≥90
Beam angle	15°/24°/36°/55°	15°/24°/36°/55°	15°/24°/36°/55°
CCT	2700K/3000K/4000K/5000K	2700K/3000K/4000K/5000K	2700K/3000K/4000K/5000K
Life time	50000 h	50000 h	50000 h
IP	IP20	IP20	IP20

Linan

Linan - 8/16/24W

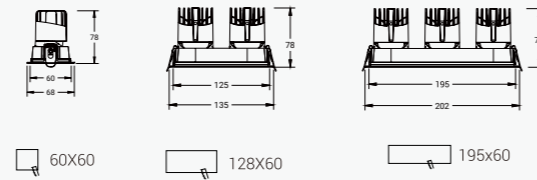
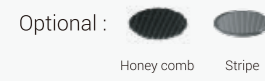

XQ- 100302P55 / XQ- 100302P55-2 / XQ- 100302P55-3

Model Code	XQ- 100302P55	XQ- 100302P55-2	XQ- 100302P55-3
Power	8W	2X8W	3X8W
Cut out	60X60mm	128X60mm	195X60mm
Light Source	CREE	CREE	CREE
Size(DxH)	68X68X78mm	135X68X78mm	202X68X78mm
UGR	<13	<13	<13
CRI	≥80/≥90	≥80/≥90	≥80/≥90
Beam angle	15°/24°/36°/55°	15°/24°/36°/55°	15°/24°/36°/55°
CCT	2700K/3000K/4000K/5000K	2700K/3000K/4000K/5000K	2700K/3000K/4000K/5000K
Life time	50000 h	50000 h	50000 h
IP	IP20	IP20	IP20

Linan

Linan - 10W

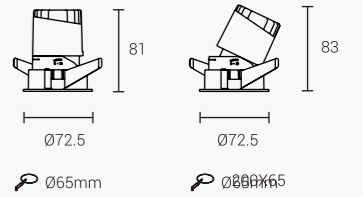

XQ-100301E65/ XQ-100302E65 / XQ-100303E65(LENS)

Model Code	XQ-100301E65	XQ-100302E65	XQ-100303E65
Power	10W	10W	10W
Cut out	Φ65mm	Φ65mm	Φ65mm
Light Source	CREE	CREE	CREE
Size(DxH)	Φ72.5x81mm	Φ72.5x83mm	Φ72.5x81mm
UGR	<19	<19	<19
CRI	≥80/≥90	≥80/≥90	≥80/≥90
Beam angle	10°/15°/ 24°/ 36°/55°	10°/15°/ 24°/ 36°/55°	10°/15°/ 24°/ 36°/55°
CCT	2700K/3000K/4000K/5000K	2700K/3000K/4000K/5000K	2700K/3000K/4000K/5000K
Life time	50000 h	50000 h	50000 h
IP	IP20	IP20	IP20

Linan

Linan - 6W

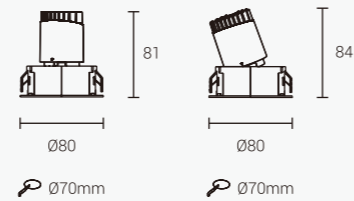
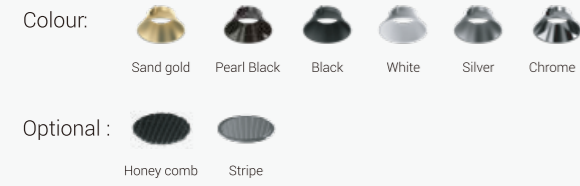

XQ-100301E70 / XQ-100302E70 / XQ-100303E70 / XQ-100304E70

Model Code	XQ-100301E70	XQ-100302E70	XQ-100303E70	XQ-100304E70
Power	6W	6W	6W	6W
Cut out	Φ70mm	Φ70mm	Φ70mm	Φ70mm
Light Source	CREE	CREE	CREE	CREE
Size(DxH)	Φ80x81mm	Φ80x84mm	Φ80x81mm	Φ80x84mm
UGR	<19	<19	<19	<19
CRI	≥80/≥90	≥80/≥90	≥80/≥90	≥80/≥90
Beam angle	10°/15°/24°/38°	10°/15°/24°/38°	10°/15°/24°/38°	10°/15°/24°/38°
CCT	2700K/3000K/4000K/5000K	2700K/3000K/4000K/5000K	2700K/3000K/4000K/5000K	2700K/3000K/4000K/5000K
Life time	50000 h	50000 h	50000 h	50000 h
IP	IP20	IP20	IP20	IP20

Linan

Linan - 2x6W

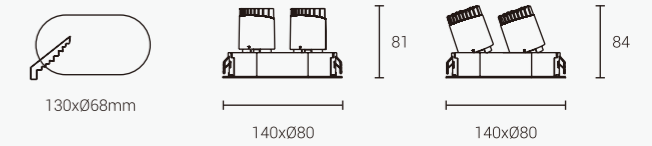
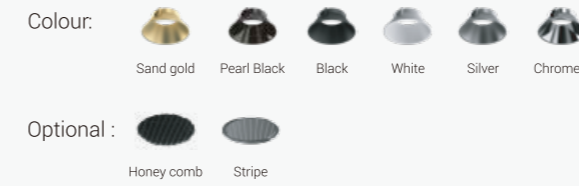
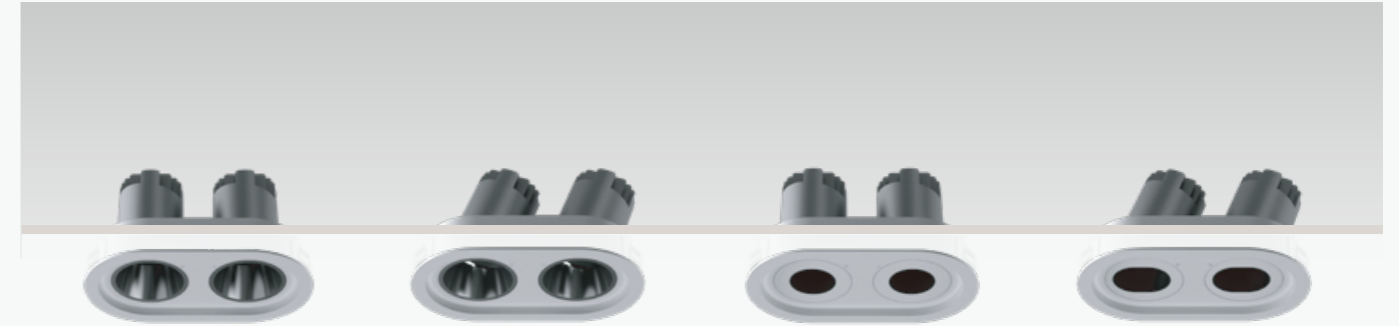

XQ-100301E70-2 / XQ-100302E70-2 / XQ-100303E70-2 / XQ-100304E70-2

Model Code	XQ-100301E70-2	XQ-100302E70-2	XQ-100303E70-2	XQ-100304E70-2
Power	2x6W	2x6W	2x6W	2x6W
Cut out	130xΦ68mm	130xΦ68mm	130xΦ68mm	130xΦ68mm
Light Source	CREE	CREE	CREE	CREE
Size(DxH)	140xΦ80x81mm	140xΦ80x84mm	140xΦ80x81mm	140xΦ80x84mm
UGR	<19	<19	<19	<19
CRI	≥80/≥90	≥80/≥90	≥80/≥90	≥80/≥90
Beam angle	10°/15°/24°/38°	10°/15°/24°/38°	10°/15°/24°/38°	10°/15°/24°/38°
CCT	2700K/3000K/4000K/5000K	2700K/3000K/4000K/5000K	2700K/3000K/4000K/5000K	2700K/3000K/4000K/5000K
Life time	50000 h	50000 h	50000 h	50000 h
IP	IP20	IP20	IP20	IP20

Linan

Linan - 3x6W

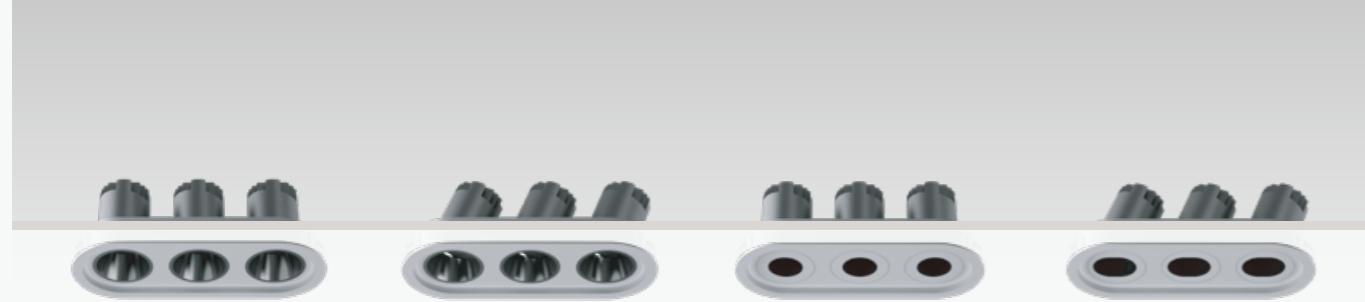

- Colour: Sand gold Pearl Black Black White Silver Chrome
- Optional: Honey comb Stripe

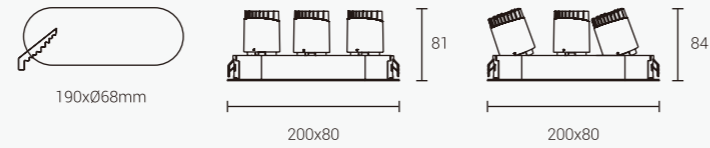

XQ-100301E70-3 / XQ-100302E70-3 / XQ-100303E70-3 / XQ-100304E70-3

Model Code	XQ-100301E70-3	XQ-100302E70-3	XQ-100303E70-3	XQ-100304E70-3
Power	3x6W	3x6W	3x6W	3x6W
Cut out	190xØ68mm	190xØ68mm	190xØ68mm	190xØ68mm
Light Source	CREE	CREE	CREE	CREE
Size(DxH)	200x80x81mm	200x80x84mm	200x80x81mm	200x80x84mm

UGR	<19	<19	<19	<19
CRI	≥80/≥90	≥80/≥90	≥80/≥90	≥80/≥90
Beam angle	10°/15°/24°/38°	10°/15°/24°/38°	10°/15°/24°/38°	10°/15°/24°/38°

CCT	2700K/3000K/4000K/5000K	2700K/3000K/4000K/5000K	2700K/3000K/4000K/5000K	2700K/3000K/4000K/5000K
Life time	50000 h	50000 h	50000 h	50000 h
IP	IP20	IP20	IP20	IP20

Linan

Linan - 4x6W

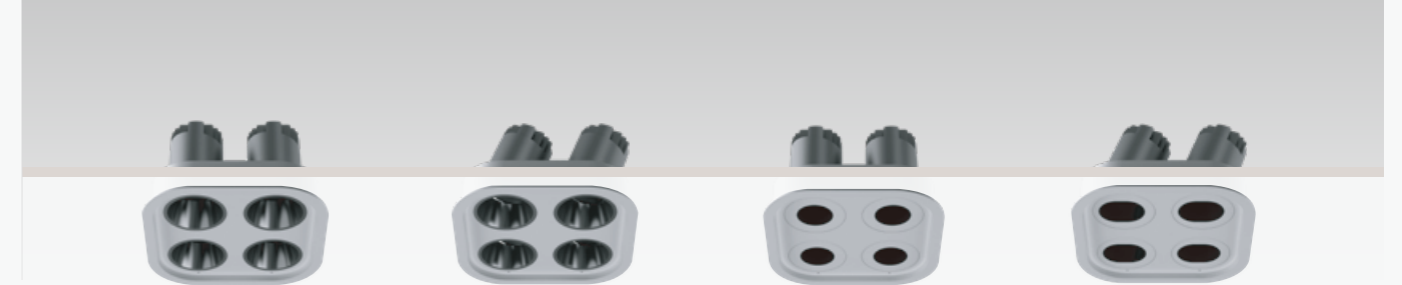

- Colour: Sand gold Pearl Black Black White Silver Chrome
- Optional: Honey comb Stripe

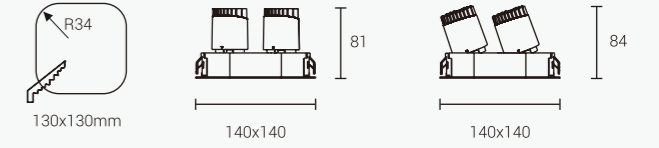

XQ-100301E70-4 / XQ-100302E70-4 / XQ-100303E70-4 / XQ-100304E70-4

Model Code	XQ-100301E70-4	XQ-100302E70-4	XQ-100303E70-4	XQ-100304E70-4
Power	4x6W	4x6W	4x6W	4x6W
Cut out	130x130mm-R34	130x130mm-R34	130x130mm-R34	130x130mm-R34
Light Source	CREE	CREE	CREE	CREE
Size(DxH)	140x140x81mm	140x140x84mm	140x140x81mm	140x140x84mm

UGR	<19	<19	<19	<19
CRI	≥80/≥90	≥80/≥90	≥80/≥90	≥80/≥90
Beam angle	10°/15°/24°/38°	10°/15°/24°/38°	10°/15°/24°/38°	10°/15°/24°/38°

CCT	2700K/3000K/4000K/5000K	2700K/3000K/4000K/5000K	2700K/3000K/4000K/5000K	2700K/3000K/4000K/5000K
Life time	50000 h	50000 h	50000 h	50000 h
IP	IP20	IP20	IP20	IP20

Linan

Linan - 6/12/18W



- Colour: Sand gold Pearl Black Black White Silver Chrome
- Optional: Honey comb Stripe

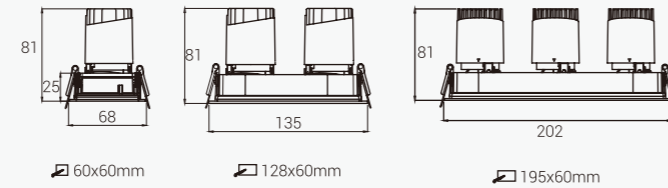

XQ-100302SE60 / XQ-100302SE60-2 / XQ-100302SE60-3

Model Code	XQ-100302SE60	XQ-100302SE60-2	XQ-100302SE60-3
Power	6W	2x6W	3x6W
Cut out	60X60mm	128X60mm	195X60mm
Light Source	CREE	CREE	CREE
Size(DxH)	68X68X81mm	135X68X81mm	202X68X81mm
UGR	<19	<19	<19
CRI	≥80/≥90	≥80/≥90	≥80/≥90
Beam angle	10°/15°/24°/38°	10°/15°/24°/38°	10°/15°/24°/38°
CCT	2700K/3000K/4000K/5000K	2700K/3000K/4000K/5000K	2700K/3000K/4000K/5000K
Life time	50000 h	50000 h	50000 h
IP	IP20	IP20	IP20

Linan

Linan - 12/18W



- Colour: Sand gold Pearl Black Black White Silver Chrome
- Optional: Honey comb Stripe

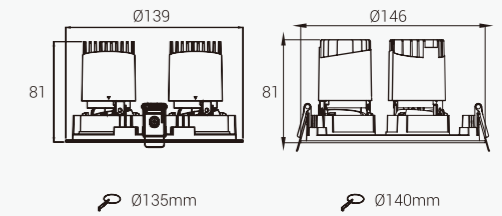

XQ-100302RE60-2 / XQ-100302RE60-3

Model Code	XQ-100302RE60-2	XQ-100302RE60-3
Power	2x6W	3x6W
Cut out	Ø135mm	Ø140mm
Light Source	CREE	CREE
Size(DxH)	139X81mm	146X81mm
UGR	<19	<19
CRI	≥80/≥90	≥80/≥90
Beam angle	10°/15°/24°/38°	10°/15°/24°/38°
CCT	2700K/3000K/4000K/5000K	2700K/3000K/4000K/5000K
Life time	50000 h	50000 h
IP	IP20	IP20



Linan

Linan - 12W

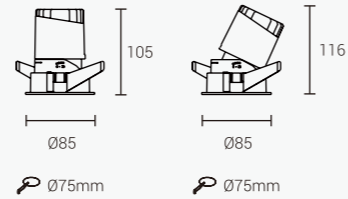
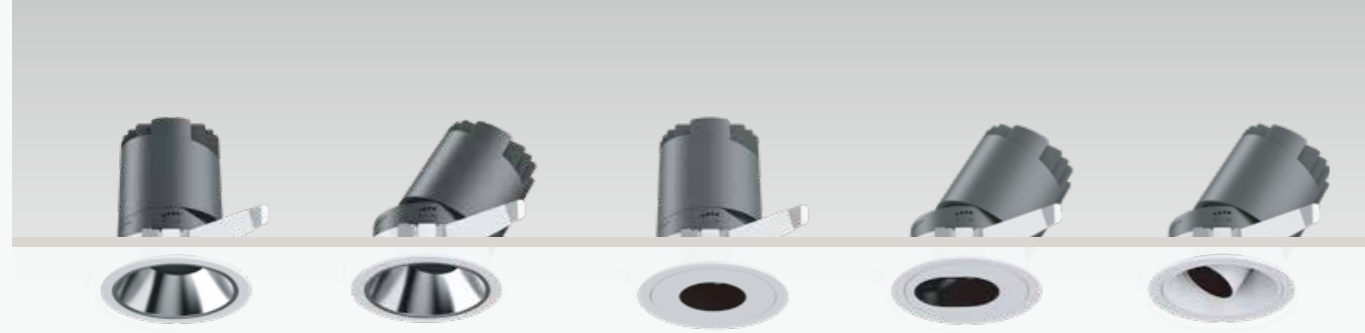

XQ-100301E75 / XQ-100302E75 / XQ-100303E75 / XQ-100304E75/ XQ-100305E75 (Reflective)

Model Code	XQ-100301E75	XQ-100302E75	XQ-100303E75	XQ-100304E75	XQ-100305E75
Power	12W	12W	12W	12W	12W
Cut out	Φ75mm	Φ75mm	Φ75mm	Φ75mm	Φ75mm
Light Source	CREE	CREE	CREE	CREE	CREE
Size(DxH)	Φ85x105mm	Φ85x116mm	Φ85x105mm	Φ85x116mm	Φ85x116mm
UGR	<19	<19	<19	<19	<19
CRI	≥80/≥90	≥80/≥90	≥80/≥90	≥80/≥90	≥80/≥90
Beam angle	15°/24°/38°	15°/24°/38°	15°/24°/38°	15°/24°/38°	15°/24°/38°
CCT	2700K/3000K/4000K/5000K	2700K/3000K/4000K/5000K	2700K/3000K/4000K/5000K	2700K/3000K/4000K/5000K	2700K/3000K/4000K/5000K
Life time	50000 h	50000 h	50000 h	50000 h	50000 h
IP	IP20	IP20	IP20	IP20	IP20

Linan

Linan - 12W

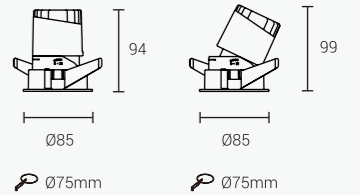

XQ-100301E75-LENS/ XQ-100302E75-LENS / XQ-100303E75-LENS / XQ-100304E75-LENS / XQ-100305E75-LENS (LENS)

Model Code	XQ-100301E75-LENS	XQ-100302E75-LENS	XQ-100303E75-LENS	XQ-100304E75-LENS	XQ-100305E75-LENS
Power	12W	12W	12W	12W	12W
Cut out	Φ75mm	Φ75mm	Φ75mm	Φ75mm	Φ75mm
Light Source	CREE	CREE	CREE	CREE	CREE
Size(DxH)	Φ85x94mm	Φ85x99mm	Φ85x94mm	Φ85x99mm	Φ85x99mm
UGR	<19	<19	<19	<19	<19
CRI	≥80/≥90	≥80/≥90	≥80/≥90	≥80/≥90	≥80/≥90
Beam angle	10°/15°/ 24°/ 38°/55°	10°/15°/ 24°/ 38°/55°	10°/15°/ 24°/ 38°/55°	10°/15°/ 24°/ 38°/55°	10°/15°/ 24°/ 38°/55°
CCT	2700K/3000K/4000K/5000K	2700K/3000K/4000K/5000K	2700K/3000K/4000K/5000K	2700K/3000K/4000K/5000K	2700K/3000K/4000K/5000K
Life time	50000 h	50000 h	50000 h	50000 h	50000 h
IP	IP20	IP20	IP20	IP20	IP20

Linan

Linan - 2x12W

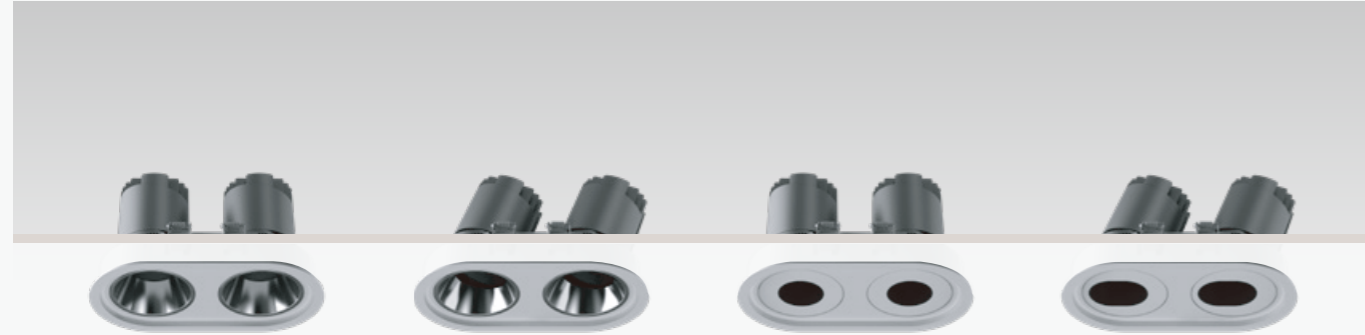

Colour:  Sand gold  Pearl Black  Black  White  Silver  Chrome

Optional :  Honey comb  Soft Lens  Square  Stripe

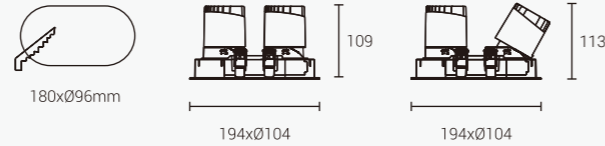

XQ-100301E75-2 / XQ-100302E75-2 / XQ-100303E75-2 / XQ-100304E75-2 (Reflective)

Model Code	XQ-100301E75-2	XQ-100302E75-2	XQ-100303E75-2	XQ-100304E75-2
Power	2x12W	2x12W	2x12W	2x12W
Cut out	180xØ96mm	180xØ96mm	180xØ96mm	180xØ96mm
Light Source	CREE	CREE	CREE	CREE
Size(DxH)	194xØ104x109mm	194xØ104x113mm	194xØ104x109mm	194xØ104x113mm
UGR	<19	<19	<19	<19
CRI	≥80/≥90	≥80/≥90	≥80/≥90	≥80/≥90
Beam angle	15°/24°/38°	15°/24°/38°	15°/24°/38°	15°/24°/38°
CCT	2700K/3000K/4000K/5000K	2700K/3000K/4000K/5000K	2700K/3000K/4000K/5000K	2700K/3000K/4000K/5000K
Life time	50000 h	50000 h	50000 h	50000 h
IP	IP20	IP20	IP20	IP20

Linan

Linan - 2x12W

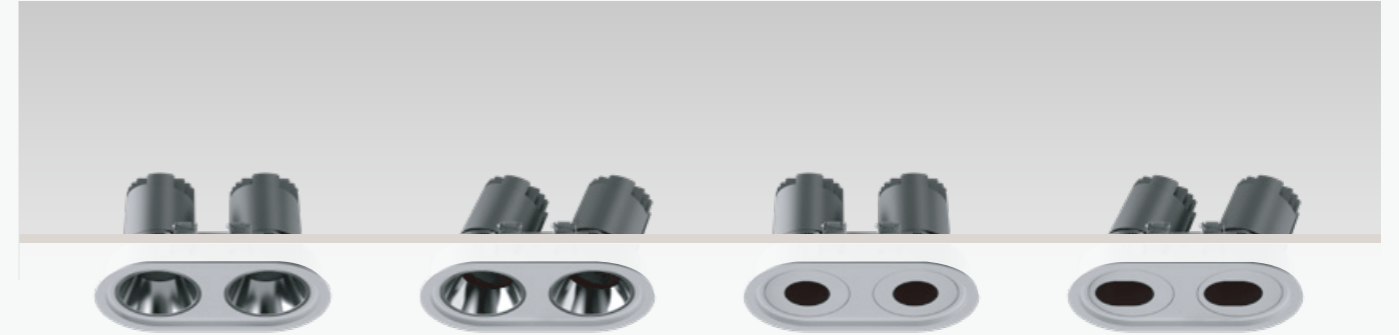

Colour:  Sand gold  Pearl Black  Black  White  Silver  Chrome

Optional :  Honey comb  Soft Lens  Square  Stripe

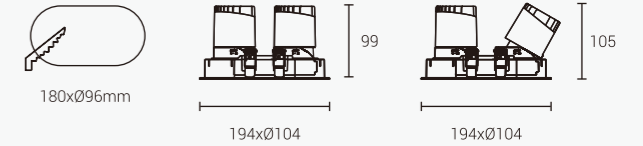

XQ-100301E75-2 -LENS/ XQ-100302E75-2-LENS / XQ-100303E75-2-LENS / XQ-100304E75-2-LENS (LENS)

Model Code	XQ-100301E75-2-LENS	XQ-100302E75-2-LENS	XQ-100303E75-2-LENS	XQ-100304E75-2-LENS
Power	2x12W	2x12W	2x12W	2x12W
Cut out	180xØ96mm	180xØ96mm	180xØ96mm	180xØ96mm
Light Source	CREE	CREE	CREE	CREE
Size(DxH)	194xØ104x99mm	194xØ104x105mm	194xØ104x99mm	194xØ104x105mm
UGR	<19	<19	<19	<19
CRI	≥80/≥90	≥80/≥90	≥80/≥90	≥80/≥90
Beam angle	10°/15°/ 24°/ 38°/55°	10°/15°/ 24°/ 38°/55°	10°/15°/ 24°/ 38°/55°	10°/15°/ 24°/ 38°/55°
CCT	2700K/3000K/4000K/5000K	2700K/3000K/4000K/5000K	2700K/3000K/4000K/5000K	2700K/3000K/4000K/5000K
Life time	50000 h	50000 h	50000 h	50000 h
IP	IP20	IP20	IP20	IP20

Linan

Linan - 20W

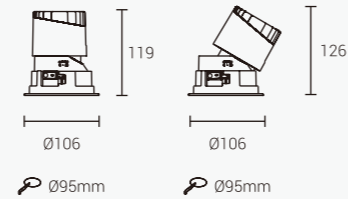
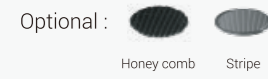
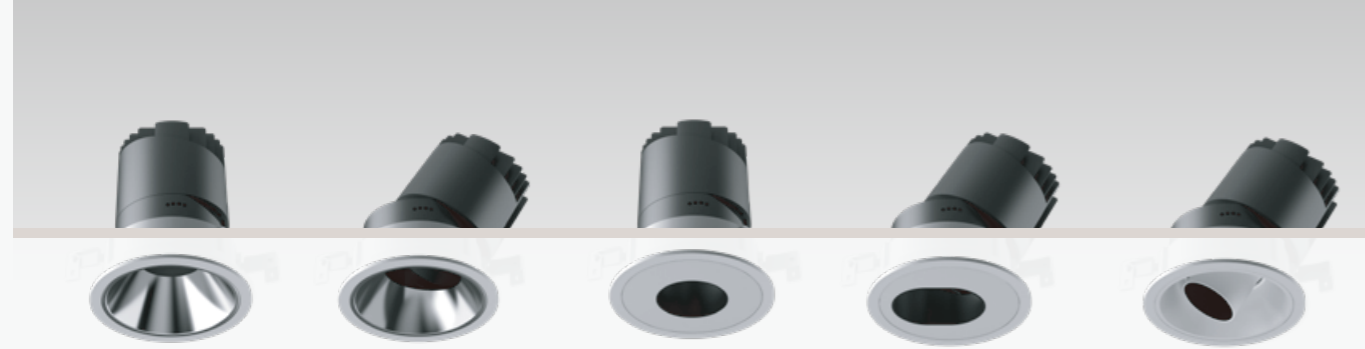

XQ-100301E95 / XQ-100302E95 / XQ-100303E95 / XQ-100304E95 / XQ-100305E95 (Reflective)

Model Code	XQ-100301E95	XQ-100302E95	XQ-100303E95	XQ-100304E95	XQ-100305E95
Power	20W	20W	20W	20W	20W
Cut out	Φ95mm	Φ95mm	Φ95mm	Φ95mm	Φ95mm
Light Source	CREE	CREE	CREE	CREE	CREE
Size(DxH)	Φ106x119mm	Φ106x126mm	Φ106x119mm	Φ106x126mm	Φ106x126mm
UGR	<19	<19	<19	<19	<19
CRI	≥80/≥90	≥80/≥90	≥80/≥90	≥80/≥90	≥80/≥90
Beam angle	15°/ 24°/ 38°	15°/ 24°/ 38°	15°/ 24°/ 38°	15°/ 24°/ 38°	15°/ 24°/ 38°
CCT	2700K/3000K/4000K/5000K	2700K/3000K/4000K/5000K	2700K/3000K/4000K/5000K	2700K/3000K/4000K/5000K	2700K/3000K/4000K/5000K
Life time	50000 h	50000 h	50000 h	50000 h	50000 h
IP	IP20	IP20	IP20	IP20	IP20

Linan

Linan - 23W

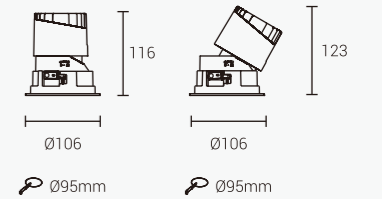
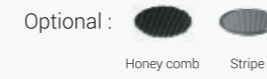

XQ-100301E95-LENS / XQ-100302E95-LENS / XQ-100303E95-LENS / XQ-100304E95-LENS / XQ-100305E95-LENS (LENS)

Model Code	XQ-100301E95-LENS	XQ-100302E95-LENS	XQ-100303E95-LENS	XQ-100304E95-LENS	XQ-100305E95-LENS
Power	23W	23W	23W	23W	23W
Cut out	Φ95mm	Φ95mm	Φ95mm	Φ95mm	Φ95mm
Light Source	CREE	CREE	CREE	CREE	CREE
Size(DxH)	Φ106x116mm	Φ106x123mm	Φ106x116mm	Φ106x123mm	Φ106x123mm
UGR	<19	<19	<19	<19	<19
CRI	≥80/≥90	≥80/≥90	≥80/≥90	≥80/≥90	≥80/≥90
Beam angle	15°/ 24°/ 38°/ 60°	15°/ 24°/ 38°/ 60°	15°/ 24°/ 38°/ 60°	15°/ 24°/ 38°/ 60°	15°/ 24°/ 38°/ 60°
CCT	2700K/3000K/4000K/5000K	2700K/3000K/4000K/5000K	2700K/3000K/4000K/5000K	2700K/3000K/4000K/5000K	2700K/3000K/4000K/5000K
Life time	50000 h	50000 h	50000 h	50000 h	50000 h
IP	IP20	IP20	IP20	IP20	IP20

Linan

Linan - 2x20W

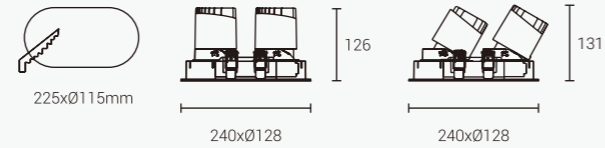
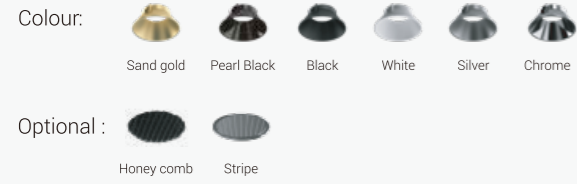
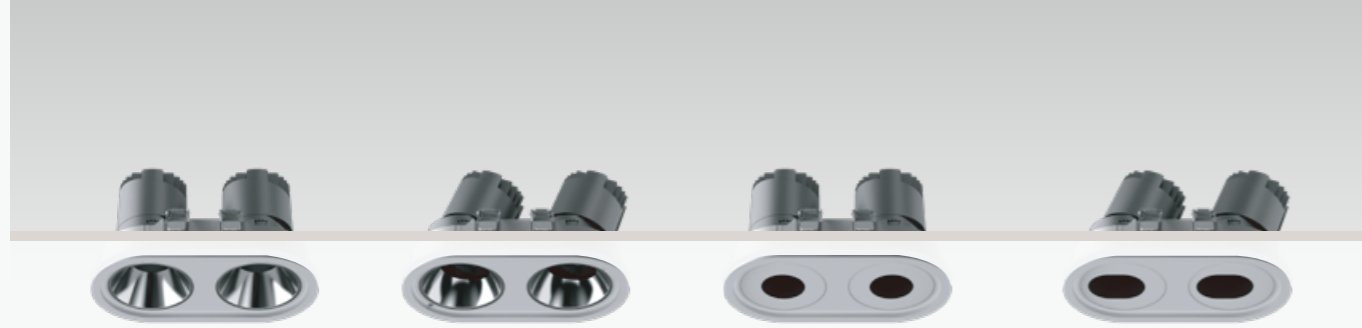

XQ-100301E95-2 / XQ-100302E95-2 / XQ-100303E95-2 / XQ-100304E95-2 (Reflective)

Model Code	XQ-100301E95-2	XQ-100302E95-2	XQ-100303E95-2	XQ-100304E95-2
Power	2x20W	2x20W	2x20W	2x20W
Cut out	225xØ115mm	225xØ115mm	225xØ115mm	225xØ115mm
Light Source	CREE	CREE	CREE	CREE
Size(DxH)	240xØ128x126mm	240xØ128x131mm	240xØ128x126mm	240xØ128x131mm
UGR	<19	<19	<19	<19
CRI	≥80/≥90	≥80/≥90	≥80/≥90	≥80/≥90
Beam angle	15°/24°/38°	15°/24°/38°	15°/24°/38°	15°/24°/38°
CCT	2700K/3000K/4000K/5000K	2700K/3000K/4000K/5000K	2700K/3000K/4000K/5000K	2700K/3000K/4000K/5000K
Life time	50000 h	50000 h	50000 h	50000 h
IP	IP20	IP20	IP20	IP20

Linan

Linan - 2x23W

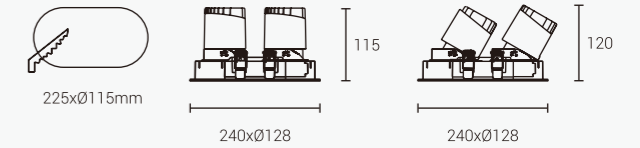
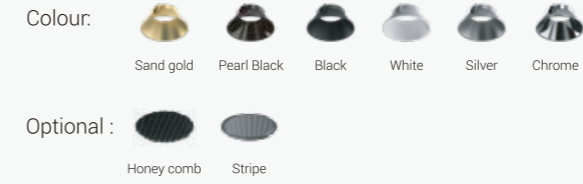
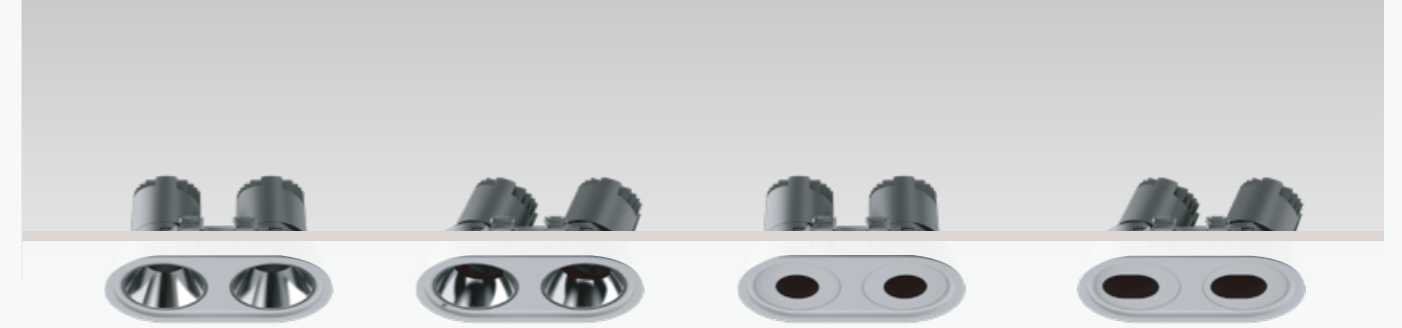

XQ-100301E95-2-LENS / XQ-100302E95-2-LENS / XQ-100303E95-2-LENS / XQ-100304E95-2-LENS (LENS)

Model Code	XQ-100301E95-2-LENS	XQ-100302E95-2-LENS	XQ-100303E95-2-LENS	XQ-100304E95-2-LENS
Power	2x23W	2x23W	2x23W	2x23W
Cut out	225xØ115mm	225xØ115mm	225xØ115mm	225xØ115mm
Light Source	CREE	CREE	CREE	CREE
Size(DxH)	240xØ128x115mm	240xØ128x120mm	240xØ128x115mm	240xØ128x120mm
UGR	<19	<19	<19	<19
CRI	≥80/≥90	≥80/≥90	≥80/≥90	≥80/≥90
Beam angle	15°/ 24°/ 38°/60°	15°/ 24°/ 38°/60°	15°/ 24°/ 38°/60°	15°/ 24°/ 38°/60°
CCT	2700K/3000K/4000K/5000K	2700K/3000K/4000K/5000K	2700K/3000K/4000K/5000K	2700K/3000K/4000K/5000K
Life time	50000 h	50000 h	50000 h	50000 h
IP	IP20	IP20	IP20	IP20

Linan

Linan - 30W

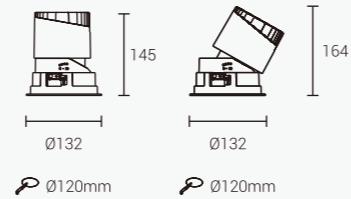

XQ-100301E120 / XQ-100302E120 / XQ-100305E120 (Reflective)

Model Code	XQ-100301E120	XQ-100302E120	XQ-100305E120
Power	30W	30W	30W
Cut out	Φ120mm	Φ120mm	Φ120mm
Light Source	CREE	CREE	CREE
Size(DxH)	Φ132x145mm	Φ132x155mm	Φ132x155mm
UGR	<19	<19	<19
CRI	≥80/≥90	≥80/≥90	≥80/≥90
Beam angle	15°/24°/38°	15°/24°/38°	15°/24°/38°
CCT	2700K/3000K/4000K/5000K	2700K/3000K/4000K/5000K	2700K/3000K/4000K/5000K
Life time	50000 h	50000 h	50000 h
IP	IP20	IP20	IP20

Linan

Linan - 38W

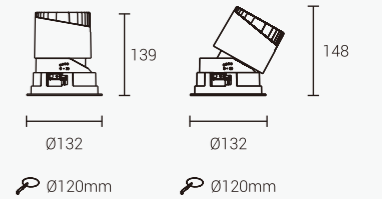

XQ-100301E120-LENS / XQ-100302E120-LENS / XQ-100305E120-LENS (LENS)

Model Code	XQ-100301E120-LENS	XQ-100302E120-LENS	XQ-100305E120-LENS
Power	38W	38W	38W
Cut out	Φ120mm	Φ120mm	Φ120mm
Light Source	CREE	CREE	CREE
Size(DxH)	Φ132x139mm	Φ132x148mm	Φ132x148mm
UGR	<19	<19	<19
CRI	≥80/≥90	≥80/≥90	≥80/≥90
Beam angle	15°/24°/38°/50°	15°/24°/36°/50°	15°/24°/36°/50°
CCT	2700K/3000K/4000K/5000K	2700K/3000K/4000K/5000K	2700K/3000K/4000K/5000K
Life time	50000 h	50000 h	50000 h
IP	IP20	IP20	IP20

Linan

Linan - 2x30W

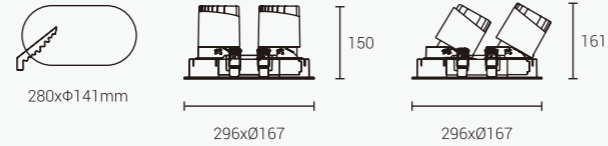

XQ-100301E120-2 / XQ-100302E120-2 / XQ-100305E120-2 (Reflective)

Model Code	XQ-100301E120-2	XQ-100302E120-2	XQ-100305E120-2
Power	2x30W	2x30W	2x30W
Cut out	280xΦ141mm	280xΦ141mm	280xΦ141mm
Light Source	CREE	CREE	CREE
Size(DxH)	296xΦ167x150mm	296xΦ167x161mm	296xΦ167x161mm
UGR	<19	<19	<19
CRI	≥80/≥90	≥80/≥90	≥80/≥90
Beam angle	15°/24°/38°	15°/24°/38°	15°/24°/38°
CCT	2700K/3000K/4000K/5000K	2700K/3000K/4000K/5000K	2700K/3000K/4000K/5000K
Life time	50000 h	50000 h	50000 h
IP	IP20	IP20	IP20

Linan

Linan - 2x38W

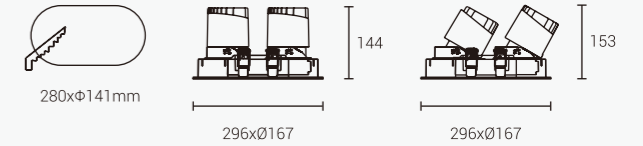

XQ-100301E120-2-LENS / XQ-100302E120-2-LENS / XQ-100305E120-2-LENS (LENS)

Model Code	XQ-100301E120-2-LENS	XQ-100302E120-2-LENS	XQ-100305E120-2-LENS
Power	2x38W	2x38W	2x38W
Cut out	280xΦ141mm	280xΦ141mm	280xΦ141mm
Light Source	CREE	CREE	CREE
Size(DxH)	296xΦ167x144mm	296xΦ167x153mm	296xΦ167x153mm
UGR	<19	<19	<19
CRI	≥80/≥90	≥80/≥90	≥80/≥90
Beam angle	15°/24°/38°/50°	15°/24°/38°/50°	15°/24°/38°/50°
CCT	2700K/3000K/4000K/5000K	2700K/3000K/4000K/5000K	2700K/3000K/4000K/5000K
Life time	50000 h	50000 h	50000 h
IP	IP20	IP20	IP20

Linan

Linan - 30W

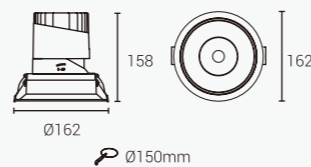

XQ-100301E150 / XQ-100302E150 / XQ-100305E150 (Reflective)

Model Code	XQ-100301E150	XQ-100302E150	XQ-100305E150
Power	30W	30W	30W
Cut out	Φ150mm	Φ150mm	Φ150mm
Light Source	CREE	CREE	CREE
Size(DxH)	Φ162x154mm	Φ162x158mm	Φ162x158mm

UGR	<19	<19	<19
CRI	≥80/≥90	≥80/≥90	≥80/≥90
Beam angle	15°/24°/38°	15°/24°/38°	15°/24°/38°

CCT	2700K/3000K/4000K/5000K	2700K/3000K/4000K/5000K	2700K/3000K/4000K/5000K
Life time	50000 h	50000 h	50000 h
IP	IP20	IP20	IP20

Linan

Linan - 38W

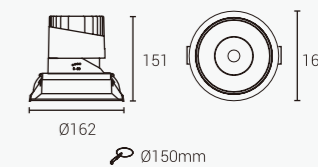

XQ-100301E150-LENS / XQ-100302E150-LENS / XQ-100305E150-LENS (LENS)

Model Code	XQ-100301E150-LENS	XQ-100302E150-LENS	XQ-100305E150-LENS
Power	38W	38W	38W
Cut out	Φ150mm	Φ150mm	Φ150mm
Light Source	CREE	CREE	CREE
Size(DxH)	Φ162x151mm	Φ162x155mm	Φ162x155mm

UGR	<19	<19	<19
CRI	≥80/≥90	≥80/≥90	≥80/≥90
Beam angle	15°/ 24°/ 38°/ 50°	15°/ 24°/ 38°/ 50°	15°/ 24°/ 38°/ 50°

CCT	2700K/3000K/4000K/5000K	2700K/3000K/4000K/5000K	2700K/3000K/4000K/5000K
Life time	50000 h	50000 h	50000 h
IP	IP20	IP20	IP20

Linan

Linan



Linan

Linan - 6W











XQ-100301T50 / XQ-100302T50 / XQ-100303T50 / XQ-100304T50

Model Code	XQ-100301T50	XQ-100302T50	XQ-100303T50	XQ-100304T50
Power	6W	6W	6W	6W
Cut out	Φ50mm	Φ50mm	Φ50mm	Φ50mm
Light Source	CREE	CREE	CREE	CREE
Size(DxH)	107x75mm	107x78mm	107x75mm	107x78mm
UGR	<19	<19	<19	<19
CRI	≥80/≥90	≥80/≥90	≥80/≥90	≥80/≥90
Beam angle	10°/15°/24°/38°	10°/15°/24°/38°	10°/15°/24°/38°	10°/15°/24°/38°
CCT	2700K/3000K/4000K/5000K	2700K/3000K/4000K/5000K	2700K/3000K/4000K/5000K	2700K/3000K/4000K/5000K
Life time	50000 h	50000 h	50000 h	50000 h
IP	IP20	IP20	IP20	IP20

Linan

Linan - 8W



- Colour:      
- Optional:  

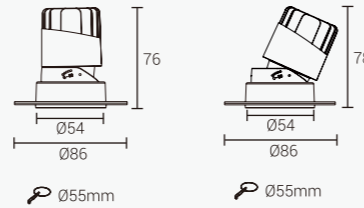







XQ-100301YT55 / XQ-100302YT55 / XQ-100303YT55

Model Code	XQ-100301YT55	XQ-100302YT55	XQ-100303YT55
Power	8W	8W	8W
Cut out	Φ55mm	Φ55mm	Φ55mm
Light Source	CREE	CREE	CREE
Size(DxH)	Φ86xH76mm	Φ86xH78mm	Φ86xH76mm
UGR	<13	<13	<13
CRI	≥80/≥90	≥80/≥90	≥80/≥90
Beam angle	15°/24°/36°/55°	15°/24°/36°/55°	15°/24°/36°/55°
CCT	2700K/3000K/4000K/5000K	2700K/3000K/4000K/5000K	2700K/3000K/4000K/5000K
Life time	50000 h	50000 h	50000 h
IP	IP20	IP20	IP20

Linan

Linan - 8/16/24W



- Colour:      
- Optional:  

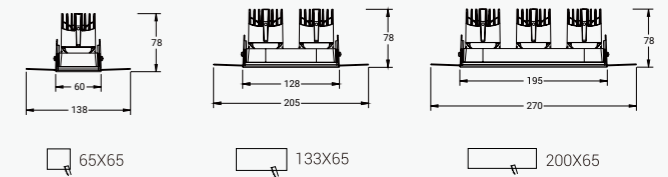

XQ-100302PT55 / XQ-100302PT55-2 / XQ-100302PT55-3



Model Code	XQ-100302PT55	XQ-100302PT55-2	XQ-100302PT55-3
Power	8W	2X8W	3X8W
Cut out	65x65mm	133x65mm	200x65mm
Light Source	CREE	CREE	CREE
Size(DxH)	138X68X78mm	205X68X78mm	272X68X78mm
UGR	<13	<13	<13
CRI	≥80/≥90	≥80/≥90	≥80/≥90
Beam angle	15°/24°/36°/55°	15°/24°/36°/55°	15°/24°/36°/55°
CCT	2700K/3000K/4000K/5000K	2700K/3000K/4000K/5000K	2700K/3000K/4000K/5000K
Life time	50000 h	50000 h	50000 h
IP	IP20	IP20	IP20

Linan

Linan - 8/16/24W



Colour:      

Optional :  

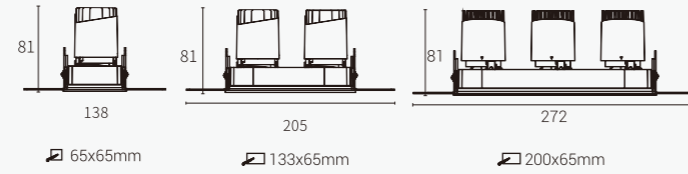

XQ-100302ST60 / XQ-100302ST60-2 / XQ-100302ST60-3

Model Code	XQ-100302ST60	XQ-100302ST60-2	XQ-100302ST60-3
Power	6W	2x6W	3x6W
Cut out	65X65mm	133X65mm	200X65mm
Light Source	CREE	CREE	CREE
Size(DxH)	138X68X81mm	205X68X81mm	272X68X81mm

UGR	<19	<19	<19
CRI	≥80/≥90	≥80/≥90	≥80/≥90
Beam angle	10°/15°/24°/38°	10°/15°/24°/38°	10°/15°/24°/38°



CCT	2700K/3000K/4000K/5000K	2700K/3000K/4000K/5000K	2700K/3000K/4000K/5000K
Life time	50000 h	50000 h	50000 h
IP	IP20	IP20	IP20

Linan

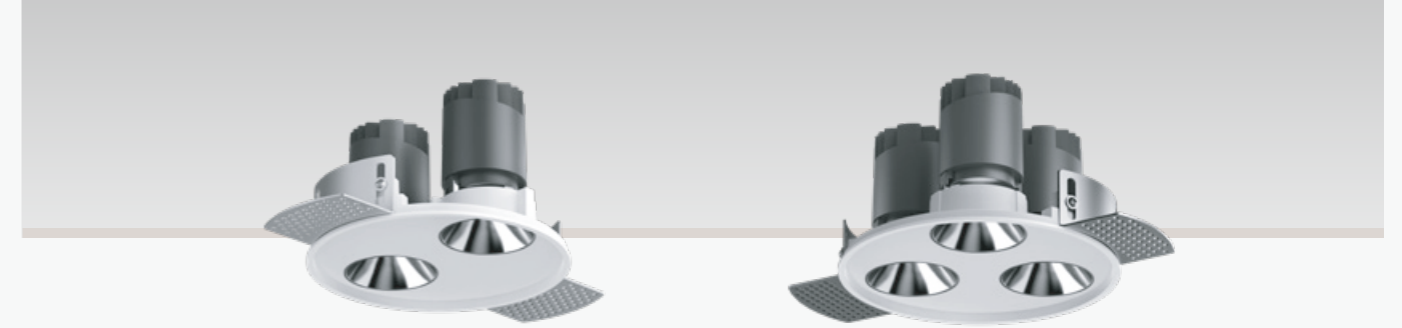
Linan - 16/24W



Colour:      

Optional :  

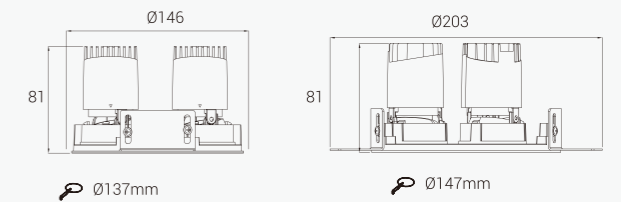

XQ-100302RT60-2 / XQ-100302RT60-3

Model Code	XQ-100302RT60-2	XQ-100302RT60-3
Power	2x6W	3x6W
Cut out	Φ137mm	Φ147mm
Light Source	CREE	CREE
Size(DxH)	146X81mm	203X81mm

UGR	<19	<19
CRI	≥80/≥90	≥80/≥90
Beam angle	10°/15°/24°/38°	10°/15°/24°/38°

CCT	2700K/3000K/4000K/5000K	2700K/3000K/4000K/5000K
Life time	50000 h	50000 h
IP	IP20	IP20

Linan

Linan - 10W

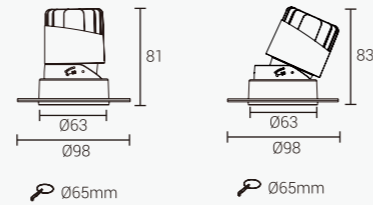
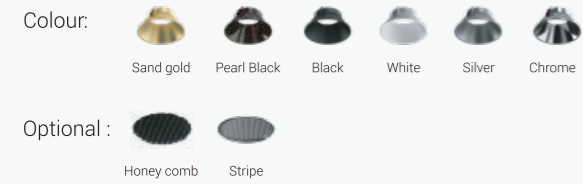

XQ-100301YT65 / XQ-100302YT65 (LENS)

Model Code	XQ-100301YT65	XQ-100302YT65
Power	10W	10W
Cut out	Φ65mm	Φ65mm
Light Source	CREE	CREE
Size(DxH)	Φ98x81mm	Φ98x83mm

UGR	<13	<13
CRI	≥80/≥90	≥80/≥90
Beam angle	10°/15°/24°/36°/55°	10°/15°/24°/36°/55°

CCT	2700K/3000K/4000K/5000K	2700K/3000K/4000K/5000K
Life time	50000 h	50000 h
IP	IP20	IP20

Linan

Linan - 6W

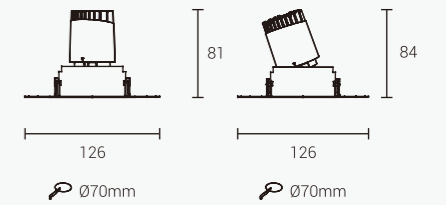
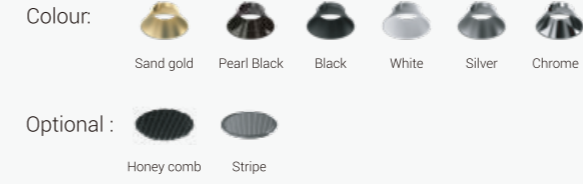

XQ-100301T70 / XQ-100302T70 / XQ-100303T70 / XQ-100304T70

Model Code	XQ-100301T70	XQ-100302T70	XQ-100303T70	XQ-100304T70
Power	6W	6W	6W	6W
Cut out	Φ70mm	Φ70mm	Φ70mm	Φ70mm
Light Source	CREE	CREE	CREE	CREE
Size(DxH)	126x81mm	126x84mm	126x81mm	126x84mm

UGR	<19	<19	<19	<19
CRI	≥80/≥90	≥80/≥90	≥80/≥90	≥80/≥90
Beam angle	10°/15°/24°/38°	10°/15°/24°/38°	10°/15°/24°/38°	10°/15°/24°/38°

CCT	2700K/3000K/4000K/5000K	2700K/3000K/4000K/5000K	2700K/3000K/4000K/5000K	2700K/3000K/4000K/5000K
Life time	50000 h	50000 h	50000 h	50000 h
IP	IP20	IP20	IP20	IP20

Linan

Linan - 2x6W

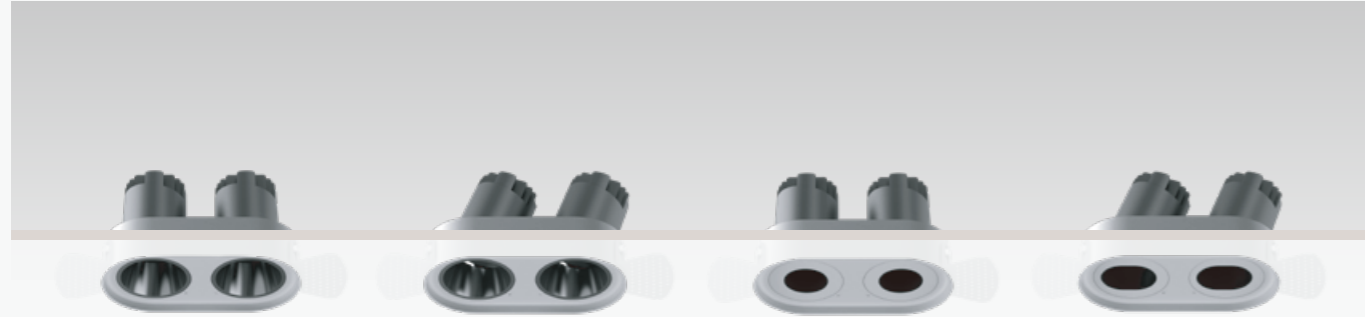

- Colour:
- Sand gold
 - Pearl Black
 - Black
 - White
 - Silver
 - Chrome
- Optional:
- Honey comb
 - Stripe

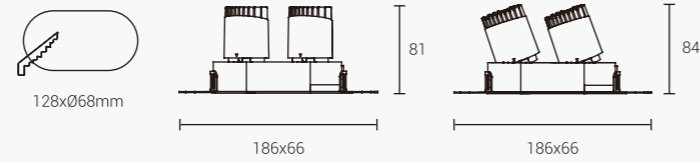

XQ-100301T70-2 / XQ-100302T70-2 / XQ-100303T70-2 / XQ-100304T70-2

Model Code	XQ-100301T70-2	XQ-100302T70-2	XQ-100303T70-2	XQ-100304T70-2
Power	2x6W	2x6W	2x6W	2x6W
Cut out	128xØ68mm	128xØ68mm	128xØ68mm	128xØ68mm
Light Source	CREE	CREE	CREE	CREE
Size(DxH)	186x66x81mm	186x66x84mm	186x66x81mm	186x66x84mm
UGR	<19	<19	<19	<19
CRI	≥80/≥90	≥80/≥90	≥80/≥90	≥80/≥90
Beam angle	10°/15°/24°/38°	10°/15°/24°/38°	10°/15°/24°/38°	10°/15°/24°/38°
CCT	2700K/3000K/4000K/5000K	2700K/3000K/4000K/5000K	2700K/3000K/4000K/5000K	2700K/3000K/4000K/5000K
Life time	50000 h	50000 h	50000 h	50000 h
IP	IP20	IP20	IP20	IP20

Linan

Linan - 3x6W

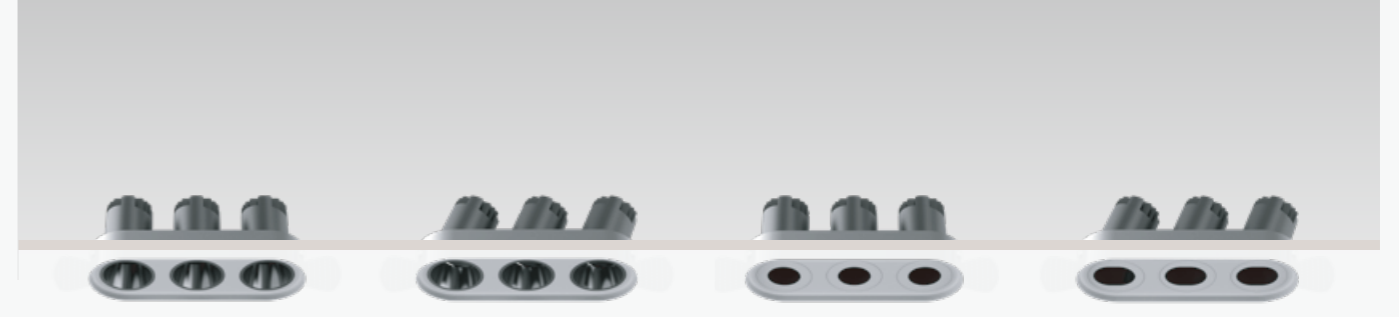

- Colour:
- Sand gold
 - Pearl Black
 - Black
 - White
 - Silver
 - Chrome
- Optional:
- Honey comb
 - Stripe

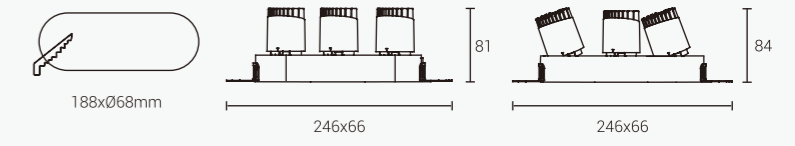

XQ-100301T70-3 / XQ-100302T70-3 / XQ-100303T70-3 / XQ-100304T70-3

Model Code	XQ-100301T70-3	XQ-100302T70-3	XQ-100303T70-3	XQ-100304T70-3
Power	3x6W	3x6W	3x6W	3x6W
Cut out	188xØ68mm	188xØ68mm	188xØ68mm	188xØ68mm
Light Source	CREE	CREE	CREE	CREE
Size(DxH)	246x66x81mm	246x66x84mm	246x66x81mm	246x66x84mm
UGR	<19	<19	<19	<19
CRI	≥80/≥90	≥80/≥90	≥80/≥90	≥80/≥90
Beam angle	10°/15°/24°/38°	10°/15°/24°/38°	10°/15°/24°/38°	10°/15°/24°/38°
CCT	2700K/3000K/4000K/5000K	2700K/3000K/4000K/5000K	2700K/3000K/4000K/5000K	2700K/3000K/4000K/5000K
Life time	50000 h	50000 h	50000 h	50000 h
IP	IP20	IP20	IP20	IP20

Linan

Linan - 4x6W



Colour: Sand gold Pearl Black Black White Silver Chrome

Optional: Honey comb Stripe

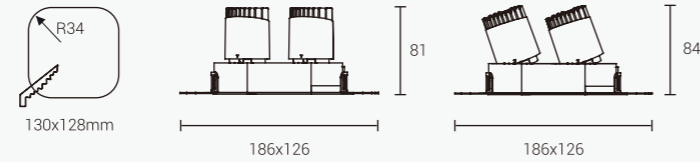

XQ-100301T70-4 / XQ-100302T70-4 / XQ-100303T70-4 / XQ-100304T70-4

Model Code	XQ-100301T70-2	XQ-100302T70-4	XQ-100303T70-4	XQ-100304T70-4
Power	4x6W	4x6W	4x6W	4x6W
Cut out	130x128mm-R34	130x128mm-R34	130x128mm-R34	130x128mm-R34
Light Source	CREE	CREE	CREE	CREE
Size(DxH)	186x126x81mm	186x126x84mm	186x126x81mm	186x126x84mm
UGR	<19	<19	<19	<19
CRI	≥80/≥90	≥80/≥90	≥80/≥90	≥80/≥90
Beam angle	10°/15°/24°/38°	10°/15°/24°/38°	10°/15°/24°/38°	10°/15°/24°/38°
CCT	2700K/3000K/4000K/5000K	2700K/3000K/4000K/5000K	2700K/3000K/4000K/5000K	2700K/3000K/4000K/5000K
Life time	50000 h	50000 h	50000 h	50000 h
IP	IP20	IP20	IP20	IP20

Linan

Linan - 12W



Colour: Sand gold Pearl Black Black White Silver Chrome

Optional: Honey comb Soft Lens Square Stripe

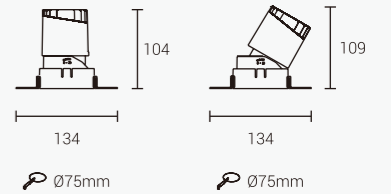

XQ-100301T75 / XQ-100302T75 / XQ-100303T75 / XQ-100304T75 / XQ-100305T75 (Reflective)

Model Code	XQ-100301T75	XQ-100302T75	XQ-100303T75	XQ-100304T75	XQ-100305E75
Power	12W	12W	12W	12W	12W
Cut out	Φ75mm	Φ75mm	Φ75mm	Φ75mm	Φ75mm
Light Source	CREE	CREE	CREE	CREE	CREE
Size(DxH)	134x104mm	134x109mm	134x104mm	134x109mm	Φ86x109mm
UGR	<19	<19	<19	<19	<19
CRI	≥80/≥90	≥80/≥90	≥80/≥90	≥80/≥90	≥80/≥90
Beam angle	15°/24°/38°	15°/24°/38°	15°/24°/38°	15°/24°/38°	15°/24°/38°
CCT	2700K/3000K/4000K/5000K	2700K/3000K/4000K/5000K	2700K/3000K/4000K/5000K	2700K/3000K/4000K/5000K	2700K/3000K/4000K/5000K
Life time	50000 h	50000 h	50000 h	50000 h	50000 h
IP	IP20	IP20	IP20	IP20	IP20

Linan

Linan - 12W

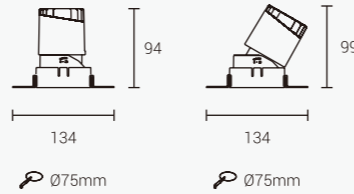

XQ-100301T75-LENS / XQ-100302T75-LENS / XQ-100303T75-LENS / XQ-100304T75-LENS / XQ-100305T75-LENS (LENS)

Model Code	XQ-100301T75-LENS	XQ-100302T75-LENS	XQ-100303T75-LENS	XQ-100304T75-LENS	XQ-100305T75-LENS
Power	12W	12W	12W	12W	12W
Cut out	Φ75mm	Φ75mm	Φ75mm	Φ75mm	Φ75mm
Light Source	CREE	CREE	CREE	CREE	CREE
Size(DxH)	134x94mm	134x99mm	134x94mm	134x99mm	134x99mm
UGR	<19	<19	<19	<19	<19
CRI	≥80/≥90	≥80/≥90	≥80/≥90	≥80/≥90	≥80/≥90
Beam angle	10°/15°/24°/38°/55°	10°/15°/24°/38°/55°	10°/15°/24°/38°/55°	10°/15°/24°/38°/55°	10°/15°/24°/38°/55°
CCT	2700K/3000K/4000K/5000K	2700K/3000K/4000K/5000K	2700K/3000K/4000K/5000K	2700K/3000K/4000K/5000K	2700K/3000K/4000K/5000K
Life time	50000 h	50000 h	50000 h	50000 h	50000 h
IP	IP20	IP20	IP20	IP20	IP20

Linan

Linan - 2x12W

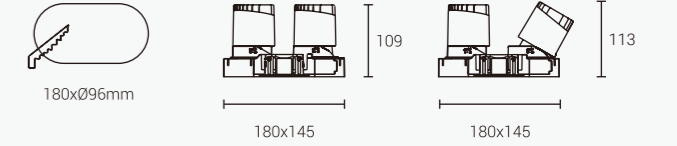
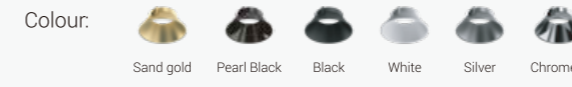

XQ-100301T75-2 / XQ-100302T75-2 / XQ-100303T75-2 / XQ-100304T75-2 (Reflective)

Model Code	XQ-100301T75-2	XQ-100302T75-2	XQ-100303T75-2	XQ-100304T75-2
Power	2x12W	2x12W	2x12W	2x12W
Cut out	180xΦ96mm	180xΦ96mm	180xΦ96mm	180xΦ96mm
Light Source	CREE	CREE	CREE	CREE
Size(DxH)	180x145x109mm	180x145x113mm	180x145x109mm	180x145x113mm
UGR	<19	<19	<19	<19
CRI	≥80/≥90	≥80/≥90	≥80/≥90	≥80/≥90
Beam angle	15°/24°/38°	15°/24°/38°	15°/24°/38°	15°/24°/38°
CCT	2700K/3000K/4000K/5000K	2700K/3000K/4000K/5000K	2700K/3000K/4000K/5000K	2700K/3000K/4000K/5000K
Life time	50000 h	50000 h	50000 h	50000 h
IP	IP20	IP20	IP20	IP20

Linan

Linan - 2x12W

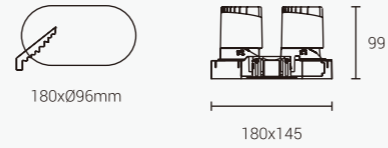

XQ-100301T75-2-LENS / XQ-100302T75-2-LENS / XQ-100303T75-2-LENS / XQ-100304T75-2-LENS (LENS)

Model Code	XQ-100301T75-2-LENS	XQ-100302T75-2-LENS	XQ-100303T75-2-LENS	XQ-100304T75-2-LENS
Power	2x12W	2x12W	2x12W	2x12W
Cut out	180xØ96mm	180xØ96mm	180xØ96mm	180xØ96mm
Light Source	CREE	CREE	CREE	CREE
Size(DxH)	180x145x99mm	180x145x99mm	180x145x99mm	180x145x99mm
UGR	<19	<19	<19	<19
CRI	≥80/≥90	≥80/≥90	≥80/≥90	≥80/≥90
Beam angle	10°/15°/24°/38°/55°	10°/15°/24°/38°/55°	10°/15°/24°/38°/55°	10°/15°/24°/38°/55°
CCT	2700K/3000K/4000K/5000K	2700K/3000K/4000K/5000K	2700K/3000K/4000K/5000K	2700K/3000K/4000K/5000K
Life time	50000 h	50000 h	50000 h	50000 h
IP	IP20	IP20	IP20	IP20

Linan

Linan - 24/40W

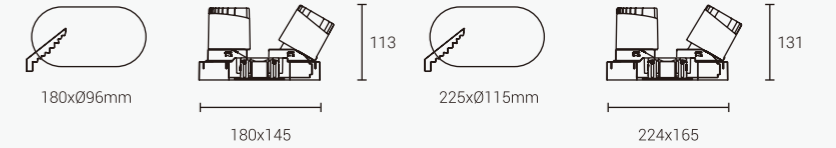

XQ-100305T75-2 / XQ-100305T95-2 (Reflective)

Model Code	XQ-100305T75-2	XQ-100305T95-2
Power	2x12W	2x20W
Cut out	180xØ96mm	225xØ115mm
Light Source	CREE	CREE
Size(DxH)	180x145x113mm	224x165x131mm
UGR	<19	<19
CRI	≥80/≥90	≥80/≥90
Beam angle	15°/24°/38°	15°/24°/38°/60°
CCT	2700K/3000K/4000K/5000K	2700K/3000K/4000K/5000K
Life time	50000 h	50000 h
IP	IP20	IP20

Linan

Linan - 24/46W

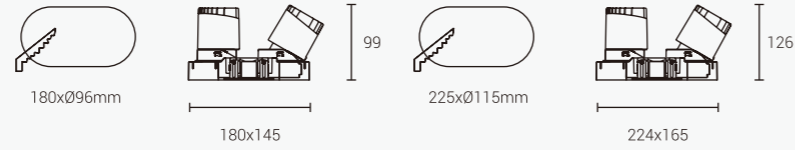

XQ-100305T75-2-LENS / XQ-100305T95-2-LENS (LENS)

Model Code	XQ-100305T75-2-LENS	XQ-100305T95-2-LENS
Power	2x12W	2x23W
Cut out	180xØ96mm	225xØ115mm
Light Source	CREE	CREE
Size(DxH)	180x145x99mm	224x165x126mm
UGR	<19	<19
CRI	≥80/≥90	≥80/≥90
Beam angle	10°/15°/24°/38°/55°	15°/24°/38°/50°
CCT	2700K/3000K/4000K/5000K	2700K/3000K/4000K/5000K
Life time	50000 h	50000 h
IP	IP20	IP20

Linan

Linan - 20W

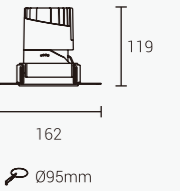
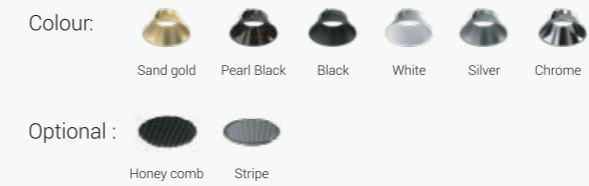

XQ-100301T95 / XQ-100302T95 / XQ-100303T95 / XQ-100304T95/ XQ-100305T95 (Reflective)

Model Code	XQ-100301T95	XQ-100302T95	XQ-100303T95	XQ-100304T95	XQ-100305T95
Power	20W	20W	20W	20W	20W
Cut out	Ø95mm	Ø95mm	Ø95mm	Ø95mm	Ø95mm
Light Source	CREE	CREE	CREE	CREE	CREE
Size(DxH)	162x119mm	162x119mm	162x119mm	162x119mm	162x119mm
UGR	<19	<19	<19	<19	<19
CRI	≥80/≥90	≥80/≥90	≥80/≥90	≥80/≥90	≥80/≥90
Beam angle	15°/24°/38°/60°	15°/24°/38°/60°	15°/24°/38°/60°	15°/24°/38°/60°	15°/24°/38°/60°
CCT	2700K/3000K/4000K/5000K	2700K/3000K/4000K/5000K	2700K/3000K/4000K/5000K	2700K/3000K/4000K/5000K	2700K/3000K/4000K/5000K
Life time	50000 h	50000 h	50000 h	50000 h	50000 h
IP	IP20	IP20	IP20	IP20	IP20

Linan

Linan - 23W

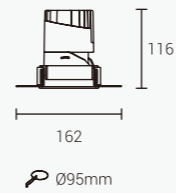
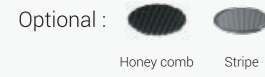

XQ-100301T95-LENS / XQ-100302T95-LENS / XQ-100303T95-LENS / XQ-100304T95-LENS/ XQ-100305T95-LENS (LENS)

Model Code	XQ-100301T95-LENS	XQ-100302T95-LENS	XQ-100303T95-LENS	XQ-100304T95-LENS	XQ-100305T95-LENS
Power	23W	23W	23W	23W	23W
Cut out	Φ95mm	Φ95mm	Φ95mm	Φ95mm	Φ95mm
Light Source	CREE	CREE	CREE	CREE	CREE
Size(DxH)	162x116mm	162x116mm	162x116mm	162x116mm	162x116mm
UGR	<19	<19	<19	<19	<19
CRI	≥80/≥90	≥80/≥90	≥80/≥90	≥80/≥90	≥80/≥90
Beam angle	15°/24°/38°/50°	15°/24°/38°/50°	15°/24°/38°/50°	15°/24°/38°/50°	15°/24°/38°/50°
CCT	2700K/3000K/4000K/5000K	2700K/3000K/4000K/5000K	2700K/3000K/4000K/5000K	2700K/3000K/4000K/5000K	2700K/3000K/4000K/5000K
Life time	50000 h	50000 h	50000 h	50000 h	50000 h
IP	IP20	IP20	IP20	IP20	IP20

Linan

Linan - 2x20W

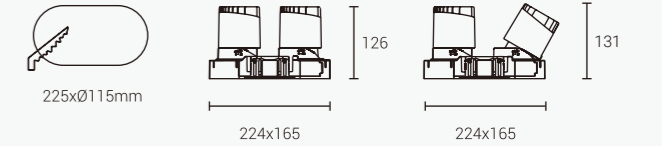
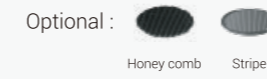
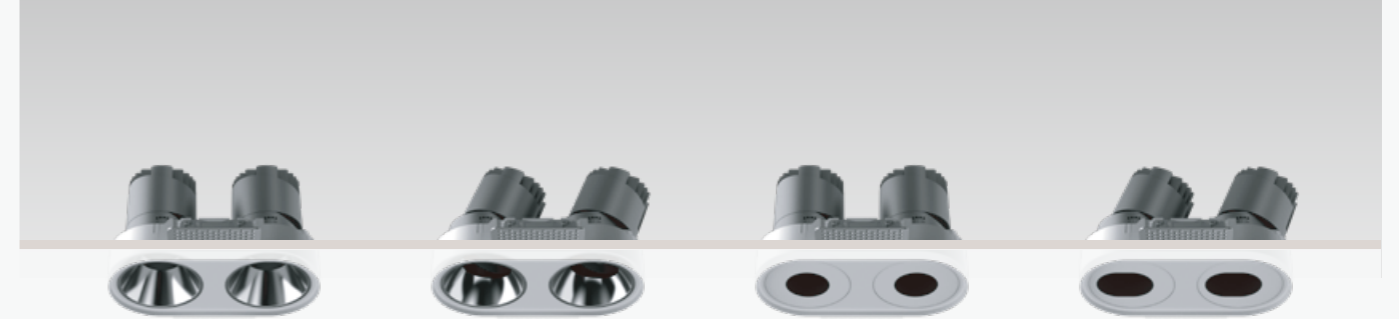

XQ-100301T95-2 / XQ-100302T95-2 / XQ-100303T95-2 / XQ-100304T95-2 (Reflective)

Model Code	XQ-100301T95-2	XQ-100302T95-2	XQ-100303T95-2	XQ-100304T95-2
Power	2x20W	2x20W	2x20W	2x20W
Cut out	225xΦ115mm	225xΦ115mm	225xΦ115mm	225xΦ115mm
Light Source	CREE	CREE	CREE	CREE
Size(DxH)	224x165x126mm	224x165x131mm	224x165x126mm	224x165x131mm
UGR	<19	<19	<19	<19
CRI	≥80/≥90	≥80/≥90	≥80/≥90	≥80/≥90
Beam angle	15°/ 24°/ 36°/ 60°	15°/ 24°/ 36°/ 60°	15°/ 24°/ 36°/ 60°	15°/ 24°/ 36°/ 60°
CCT	2700K/3000K/4000K/5000K	2700K/3000K/4000K/5000K	2700K/3000K/4000K/5000K	2700K/3000K/4000K/5000K
Life time	50000 h	50000 h	50000 h	50000 h
IP	IP20	IP20	IP20	IP20

Linan

Linan - 2x23W

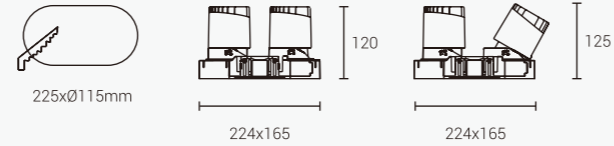
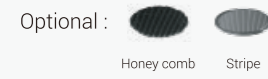
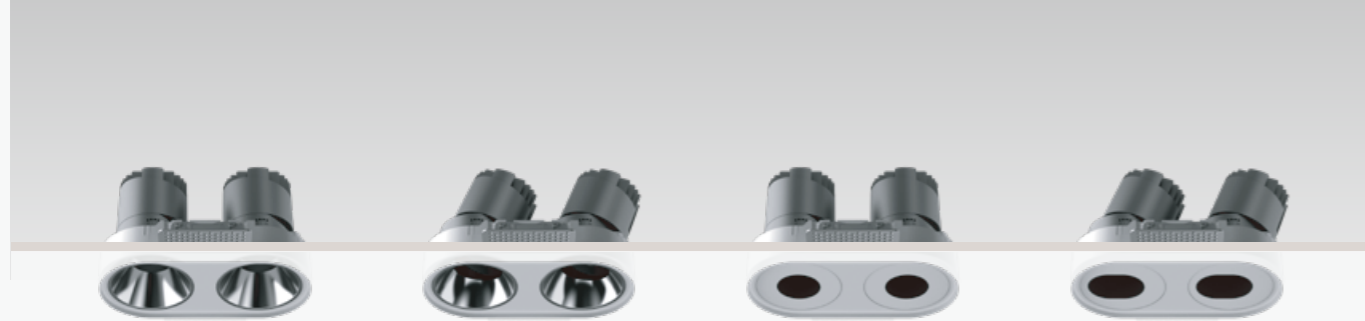

XQ-100301T95-2-LENS / XQ-100302T95-2-LENS / XQ-100303T95-2-LENS / XQ-100304T95-2-LENS (LENS)

Model Code	XQ-100301T95-2-LENS	XQ-100302T95-2-LENS	XQ-100303T95-2-LENS	XQ-100304T95-2-LENS
Power	2x23W	2x23W	2x23W	2x23W
Cut out	225xØ115mm	225xØ115mm	225xØ115mm	225xØ115mm
Light Source	CREE	CREE	CREE	CREE
Size(DxH)	224x165x120mm	224x165x125mm	224x165x120mm	224x165x125mm
UGR	<19	<19	<19	<19
CRI	≥80/≥90	≥80/≥90	≥80/≥90	≥80/≥90
Beam angle	15°/ 24°/ 36°/ 60°	15°/ 24°/ 36°/ 60°	15°/ 24°/ 36°/ 60°	15°/ 24°/ 36°/ 60°
CCT	2700K/3000K/4000K/5000K	2700K/3000K/4000K/5000K	2700K/3000K/4000K/5000K	2700K/3000K/4000K/5000K
Life time	50000 h	50000 h	50000 h	50000 h
IP	IP20	IP20	IP20	IP20

Linan

Linan - 30W

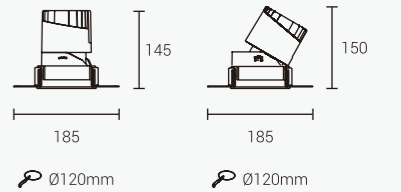

XQ-100301T120 / XQ-100302T120 / XQ-100305T120 (Reflective)

Model Code	XQ-100301T120	XQ-100302T120	XQ-100305T120
Power	30W	30W	30W
Cut out	Ø120mm	Ø120mm	Ø120mm
Light Source	CREE	CREE	CREE
Size(DxH)	185x145mm	185x150mm	185x150mm
UGR	<19	<19	<19
CRI	≥80/≥90	≥80/≥90	≥80/≥90
Beam angle	15°/24°/38°	15°/24°/38°	15°/24°/38°
CCT	2700K/3000K/4000K/5000K	2700K/3000K/4000K/5000K	2700K/3000K/4000K/5000K
Life time	50000 h	50000 h	50000 h
IP	IP20	IP20	IP20

Linan

Linan - 38W



- Colour: Sand gold Pearl Black Black White Silver Chrome
- Optional: Honey comb Soft Lens Square Stripe

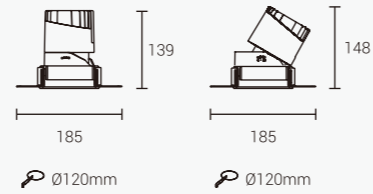

XQ-100301T120-LENS / XQ-100302T120-LENS / XQ-100305T120-LENS (LENS)

Model Code	XQ-100301T120-LENS	XQ-100302T120-LENS	XQ-100305T120-LENS
Power	38W	38W	38W
Cut out	Φ120mm	Φ120mm	Φ120mm
Light Source	CREE	CREE	CREE
Size(DxH)	185x139mm	185x148mm	185x148mm

UGR	<19	<19	<19
CRI	≥80/≥90	≥80/≥90	≥80/≥90
Beam angle	15° / 24° / 38° / 50°	15° / 24° / 38° / 50°	15° / 24° / 38° / 50°

CCT	2700K/3000K/4000K/5000K	2700K/3000K/4000K/5000K	2700K/3000K/4000K/5000K
Life time	50000 h	50000 h	50000 h
IP	IP20	IP20	IP20

Linan

Linan - 2x30W



- Colour: Sand gold Pearl Black Black White Silver Chrome
- Optional: Honey comb Soft Lens Square Stripe

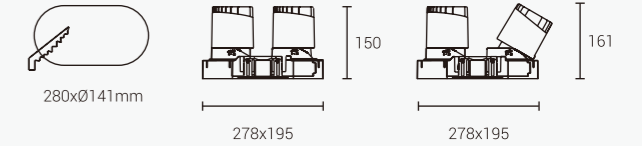

XQ-100301T120-2 / XQ-100302T120-2 / XQ-100305T120-2 (Reflective)

Model Code	XQ-100301T120-2	XQ-100302T120-2	XQ-100305T120-2
Power	2x30W	2x30W	2x30W
Cut out	280xΦ141mm	280xΦ141mm	280xΦ141mm
Light Source	CREE	CREE	CREE
Size(DxH)	278x195x150mm	278x195x161mm	278x195x161mm

UGR	<19	<19	<19
CRI	≥80/≥90	≥80/≥90	≥80/≥90
Beam angle	15° / 24° / 38°	15° / 24° / 38°	15° / 24° / 38°

CCT	2700K/3000K/4000K/5000K	2700K/3000K/4000K/5000K	2700K/3000K/4000K/5000K
Life time	50000 h	50000 h	50000 h
IP	IP20	IP20	IP20

Linan

Linan - 2x38W

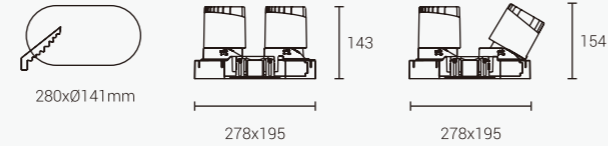

XQ-100301T120-2-LENS / XQ-100302T120-2-LENS / XQ-100305T120-2-LENS (LENS)

Model Code	XQ-100301T120-2--LENS	XQ-100302T120-2-LENS	XQ-100305T120-2-LENS
Power	2x38W	2x38W	2x38W
Cut out	280xØ141mm	280xØ141mm	280xØ141mm
Light Source	CREE	CREE	CREE
Size(DxH)	278x195x143mm	278x195x154mm	278x195x154mm
UGR	<19	<19	<19
CRI	≥80/≥90	≥80/≥90	≥80/≥90
Beam angle	15°/24°/38°/50°	15°/24°/38°/50°	15°/24°/38°/50°
CCT	2700K/3000K/4000K/5000K	2700K/3000K/4000K/5000K	2700K/3000K/4000K/5000K
Life time	50000 h	50000 h	50000 h
IP	IP20	IP20	IP20

Linan



Linan

Linan - 6W

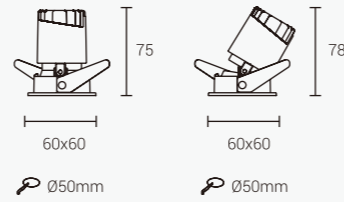
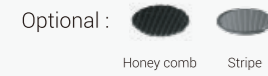
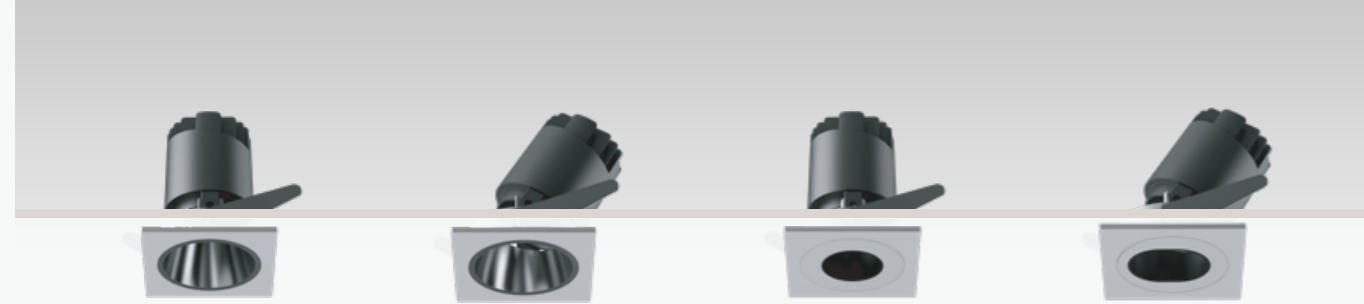

XQ-100301P50 / XQ-100302P50 / XQ-100303P50 / XQ-100304P50 (LENS)

Model Code	XQ-100301P50	XQ-100302P50	XQ-100303P50	XQ-100304P50
Power	6W	6W	6W	6W
Cut out	Φ50mm	Φ50mm	Φ50mm	Φ50mm
Light Source	CREE	CREE	CREE	CREE
Size(DxH)	60x60x75mm	60x60x78mm	60x60x75mm	60x60x78mm

UGR	<19	<19	<19	<19
CRI	≥80/≥90	≥80/≥90	≥80/≥90	≥80/≥90
Beam angle	10°/15°/24°/36°	10°/15°/24°/36°	10°/15°/24°/36°	10°/15°/24°/36°

CCT	2700K/3000K/4000K/5000K	2700K/3000K/4000K/5000K	2700K/3000K/4000K/5000K	2700K/3000K/4000K/5000K
Life time	50000 h	50000 h	50000 h	50000 h
IP	IP20	IP20	IP20	IP20

Linan

Linan - 12W

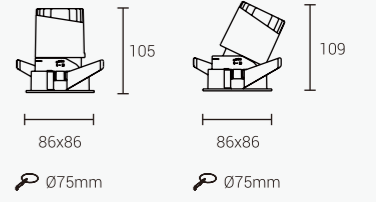
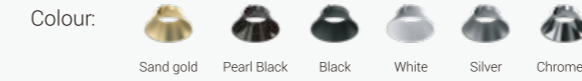

XQ-100301P75 / XQ-100302P75 / XQ-100303P75 / XQ-100304P75/ XQ-100305P75 (Reflective)

Model Code	XQ-100301P75	XQ-100302P75	XQ-100303P75	XQ-100304P75	XQ-100305P75
Power	12W	12W	12W	12W	12W
Cut out	Φ75mm	Φ75mm	Φ75mm	Φ75mm	Φ75mm
Light Source	CREE	CREE	CREE	CREE	CREE
Size(DxH)	86x86x105mm	86x86x109mm	86x86x105mm	86x86x109mm	86x86x109mm

UGR	<19	<19	<19	<19	<19
CRI	≥80/≥90	≥80/≥90	≥80/≥90	≥80/≥90	≥80/≥90
Beam angle	15°/24°/38°	15°/24°/38°	15°/24°/38°	15°/24°/38°	15°/24°/38°

CCT	2700K/3000K/4000K/5000K	2700K/3000K/4000K/5000K	2700K/3000K/4000K/5000K	2700K/3000K/4000K/5000K	2700K/3000K/4000K/5000K
Life time	50000 h	50000 h	50000 h	50000 h	50000 h
IP	IP20	IP20	IP20	IP20	IP20

Linan

Linan - 12W

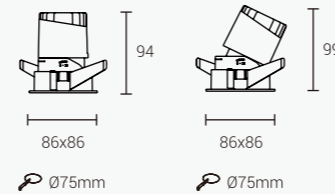

XQ-100301P75-LENS / XQ-100302P75-LENS / XQ-100303P75-LENS / XQ-100304P75-LENS/ XQ-100305P75-LENS (LENS)

Model Code	XQ-100301P75-LENS	XQ-100302P75-LENS	XQ-100303P75-LENS	XQ-100304P75-LENS	XQ-100305P75-LENS
Power	12W	12W	12W	12W	12W
Cut out	Φ75mm	Φ75mm	Φ75mm	Φ75mm	Φ75mm
Light Source	CREE	CREE	CREE	CREE	CREE
Size(DxH)	86x86x94mm	86x86x99mm	86x86x94mm	86x86x99mm	86x86x99mm

UGR	<19	<19	<19	<19	<19
CRI	≥80/≥90	≥80/≥90	≥80/≥90	≥80/≥90	≥80/≥90
Beam angle	10°/15°/24°/38°/55°	10°/15°/24°/38°/55°	10°/15°/24°/38°/55°	10°/15°/24°/38°/55°	10°/15°/24°/38°/55°

CCT	2700K/3000K/4000K/5000K	2700K/3000K/4000K/5000K	2700K/3000K/4000K/5000K	2700K/3000K/4000K/5000K	2700K/3000K/4000K/5000K
Life time	50000 h	50000 h	50000 h	50000 h	50000 h
IP	IP20	IP20	IP20	IP20	IP20

Linan

Linan - 20W

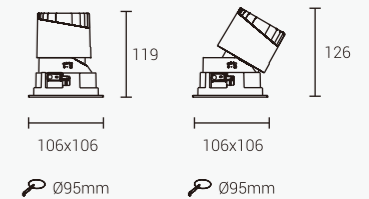
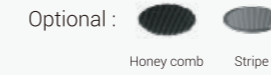
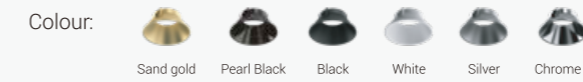

XQ-100301P95 / XQ-100302P95 / XQ-100303P95 / XQ-100304P95/ XQ-100305P95 (Reflective)

Model Code	XQ-100301P95	XQ-100302P95	XQ-100303P95	XQ-100304P95	XQ-100305P95
Power	20W	20W	20W	20W	20W
Cut out	Φ95mm	Φ95mm	Φ95mm	Φ95mm	Φ95mm
Light Source	CREE	CREE	CREE	CREE	CREE
Size(DxH)	106x106x119mm	106x106x126mm	106x106x119mm	106x106x126mm	106x106x126mm

UGR	<19	<19	<19	<19	<19
CRI	≥80/≥90	≥80/≥90	≥80/≥90	≥80/≥90	≥80/≥90
Beam angle	15°/24°/38°/60°	15°/24°/38°/60°	15°/24°/38°/60°	15°/24°/38°/60°	15°/24°/38°/60°

CCT	2700K/3000K/4000K/5000K	2700K/3000K/4000K/5000K	2700K/3000K/4000K/5000K	2700K/3000K/4000K/5000K	2700K/3000K/4000K/5000K
Life time	50000 h	50000 h	50000 h	50000 h	50000 h
IP	IP20	IP20	IP20	IP20	IP20

Linan

Linan - 23W

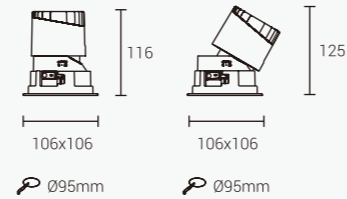
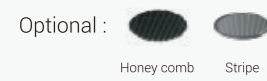

XQ-100301P95-LENS / XQ-100302P95-LENS / XQ-100303P95-LENS / XQ-100304P95-LENS/ XQ-100305P95-LENS (LENS)

Model Code	XQ-100301P95-LENS	XQ-100302P95-LENS	XQ-100303P95-LENS	XQ-100304P95-LENS	XQ-100305P95-LENS
Power	23W	23W	23W	23W	23W
Cut out	Φ95mm	Φ95mm	Φ95mm	Φ95mm	Φ95mm
Light Source	CREE	CREE	CREE	CREE	CREE
Size(DxH)	106x106x116mm	106x106x125mm	106x106x116mm	106x106x125mm	106x106x125mm
UGR	<19	<19	<19	<19	<19
CRI	≥80/≥90	≥80/≥90	≥80/≥90	≥80/≥90	≥80/≥90
Beam angle	15°/ 24°/ 36°/ 50°	15°/ 24°/ 36°/ 50°	15°/ 24°/ 36°/ 50°	15°/ 24°/ 36°/ 50°	15°/ 24°/ 36°/ 50°
CCT	2700K/3000K/4000K/5000K	2700K/3000K/4000K/5000K	2700K/3000K/4000K/5000K	2700K/3000K/4000K/5000K	2700K/3000K/4000K/5000K
Life time	50000 h	50000 h	50000 h	50000 h	50000 h
IP	IP20	IP20	IP20	IP20	IP20

Linan

Linan - 30W

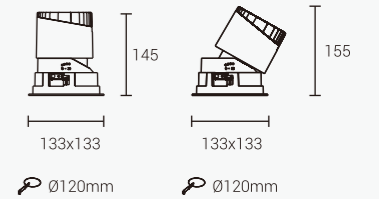
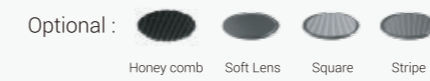
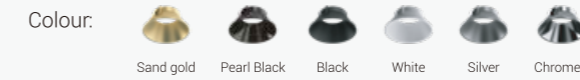

XQ-100301P120 / XQ-100302P120 / XQ-100305P120 (Reflective)

Model Code	XQ-100301P120	XQ-100302P120	XQ-100305P120
Power	30W	30W	30W
Cut out	Φ120mm	Φ120mm	Φ120mm
Light Source	CREE	CREE	CREE
Size(DxH)	133x133x145mm	133x133x155mm	133x133x155mm
UGR	<19	<19	<19
CRI	≥80/≥90	≥80/≥90	≥80/≥90
Beam angle	15°/24°/38°	15°/24°/38°	15°/24°/38°
CCT	2700K/3000K/4000K/5000K	2700K/3000K/4000K/5000K	2700K/3000K/4000K/5000K
Life time	50000 h	50000 h	50000 h
IP	IP20	IP20	IP20

Linan

Linan - 38W

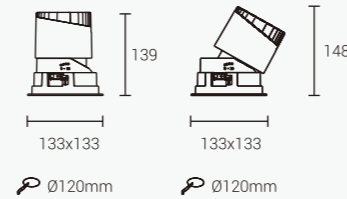
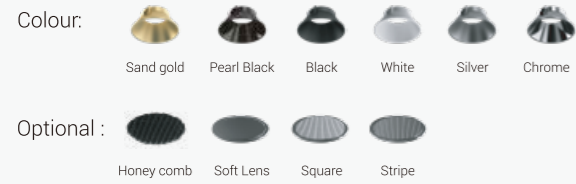

XQ-100301P120-LENS / XQ-100302P120-LENS / XQ-100305P120-LENS (LENS)

Model Code	XQ-100301P120-LENS	XQ-100302P120-LENS	XQ-100305P120-LENS
Power	38W	38W	38W
Cut out	Φ120mm	Φ120mm	Φ120mm
Light Source	CREE	CREE	CREE
Size(DxH)	133x133x139mm	133x133x148mm	133x133x148mm
UGR	<19	<19	<19
CRI	≥80/≥90	≥80/≥90	≥80/≥90
Beam angle	15°/ 24°/ 36°/ 50°	15°/ 24°/ 36°/ 50°	15°/ 24°/ 36°/ 50°
CCT	2700K/3000K/4000K/5000K	2700K/3000K/4000K/5000K	2700K/3000K/4000K/5000K
Life time	50000 h	50000 h	50000 h
IP	IP20	IP20	IP20

Linan

Linan - 82W

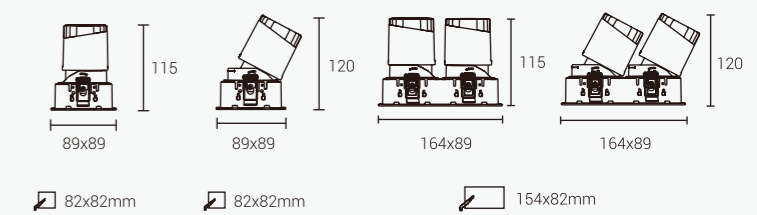
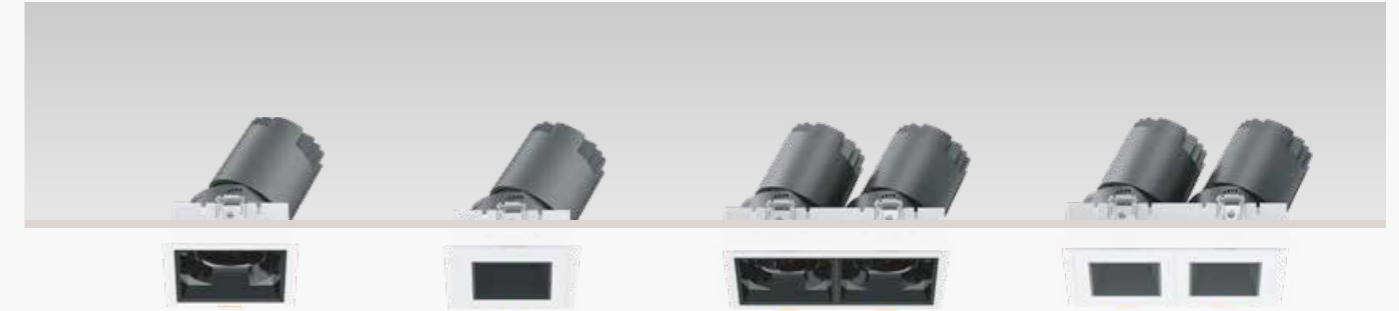

XQ-100302E82 / XQ-100303E82 / XQ-100302E82-2 / XQ-100303E82-2 (Reflective)

Model Code	XQ-100302E82	XQ-100303E82	XQ-100302E82-2	XQ-100303E82-2
Power	12W	12W	2x12W	2x12W
Cut out	82x82mm	82x82mm	154x82mm	154x82mm
Light Source	CREE	CREE	CREE	CREE
Size(DxH)	89x89x120mm	89x89x120mm	164x89x120mm	164x89x120mm
UGR	<19	<19	<19	<19
CRI	≥80/≥90	≥80/≥90	≥80/≥90	≥80/≥90
Beam angle	15°/ 24°/ 38°	15°/ 24°/ 38°	15°/ 24°/ 38°	15°/ 24°/ 38°
CCT	2700K/3000K/4000K/5000K	2700K/3000K/4000K/5000K	2700K/3000K/4000K/5000K	2700K/3000K/4000K/5000K
Life time	50000 h	50000 h	50000 h	50000 h
IP	IP20	IP20	IP20	IP20

Linan

Linan - 82W

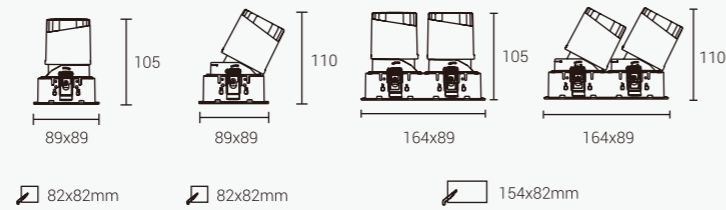
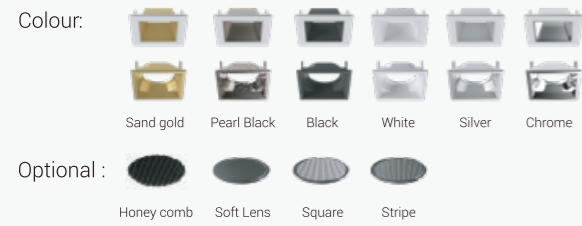

XQ-100302E82-LENS / XQ-100303E82-LENS / XQ-100302E82-2-LENS / XQ-100303E82-2-LENS (LENS)

Model Code	XQ-100302E82-LENS	XQ-100303E82-LENS	XQ-100302E82-2-LENS	XQ-100303E82-2-LENS
Power	12W	12W	12W	12W
Cut out	82x82mm	82x82mm	154x82mm	154x82mm
Light Source	CREE	CREE	CREE	CREE
Size(DxH)	89x89x110mm	89x89x110mm	164x89x110mm	164x89x110mm

UGR	<19	<19	<19	<19
CRI	≥80/≥90	≥80/≥90	≥80/≥90	≥80/≥90
Beam angle	10°/15°/ 24°/ 36°/55°	10°/15°/ 24°/ 36°/55°	10°/15°/ 24°/ 36°/55°	10°/15°/ 24°/ 36°/55°

CCT	2700K/3000K/4000K/5000K	2700K/3000K/4000K/5000K	2700K/3000K/4000K/5000K	2700K/3000K/4000K/5000K
Life time	50000 h	50000 h	50000 h	50000 h
IP	IP20	IP20	IP20	IP20

Linan

Linan - 82W

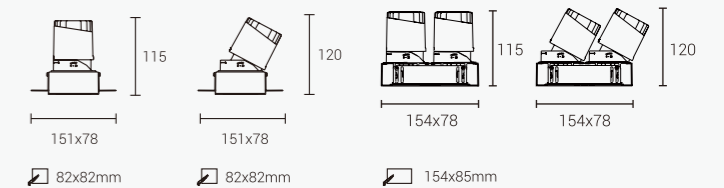
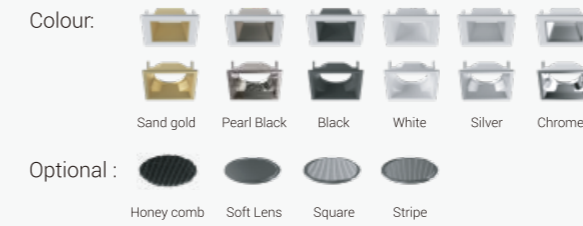

XQ-100302T82 / XQ-100303T82 / XQ-100302T82-2 / XQ-100303T82-2 (Reflective)

Model Code	XQ-100302T82	XQ-100303T82	XQ-100302T82-2	XQ-100303T82-2
Power	12W	12W	2x12W	2x12W
Cut out	82x82mm	82x82mm	154x85mm	154x85mm
Light Source	CREE	CREE	CREE	CREE
Size(DxH)	151x78x120mm	151x78x120mm	154x78x120mm	154x78x120mm

UGR	<19	<19	<19	<19
CRI	≥80/≥90	≥80/≥90	≥80/≥90	≥80/≥90
Beam angle	15°/ 24°/ 38°	15°/ 24°/ 38°	15°/ 24°/ 38°	15°/ 24°/ 38°

CCT	2700K/3000K/4000K/5000K	2700K/3000K/4000K/5000K	2700K/3000K/4000K/5000K	2700K/3000K/4000K/5000K
Life time	50000 h	50000 h	50000 h	50000 h
IP	IP20	IP20	IP20	IP20

Linan

Linan - 82W

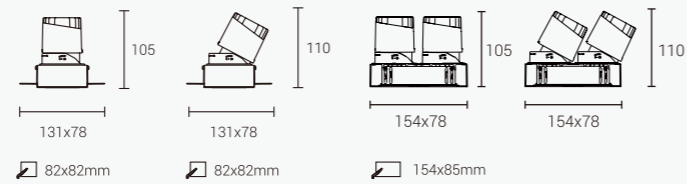

XQ-100302T82-LENS / XQ-100303T82-LENS / XQ-100302T82-2-LENS / XQ-100303T82-2-LENS (LENS)

Model Code	XQ-100302T82-LENS	XQ-100303T82-LENS	XQ-100302T82-2-LENS	XQ-100303T82-2-LENS
Power	12W	12W	2x12W	2x12W
Cut out	82x82mm	82x82mm	154x85mm	154x85mm
Light Source	CREE	CREE	CREE	CREE
Size(DxH)	131x78x110mm	131x78x110mm	154x78x110mm	154x78x110mm
UGR	<19	<19	<19	<19
CRI	≥80/≥90	≥80/≥90	≥80/≥90	≥80/≥90
Beam angle	10°/15°/ 24°/ 36°/55°	10°/15°/ 24°/ 36°/55°	10°/15°/ 24°/ 36°/55°	10°/15°/ 24°/ 36°/55°
CCT	2700K/3000K/4000K/5000K	2700K/3000K/4000K/5000K	2700K/3000K/4000K/5000K	2700K/3000K/4000K/5000K
Life time	50000 h	50000 h	50000 h	50000 h
IP	IP20	IP20	IP20	IP20



LED Panel

Technical Operating & Electrical Data

Input Voltage & Frequency	AC220-240V, 50/60Hz
Rated CRI	95
Beam Angle	120°
Dimming	Non-Dimmable
IP Rating	IP44 (Front)- IP20 (Back)
Body Material	Steel+Polystyrene
Life Span	50000h

Areas of Application

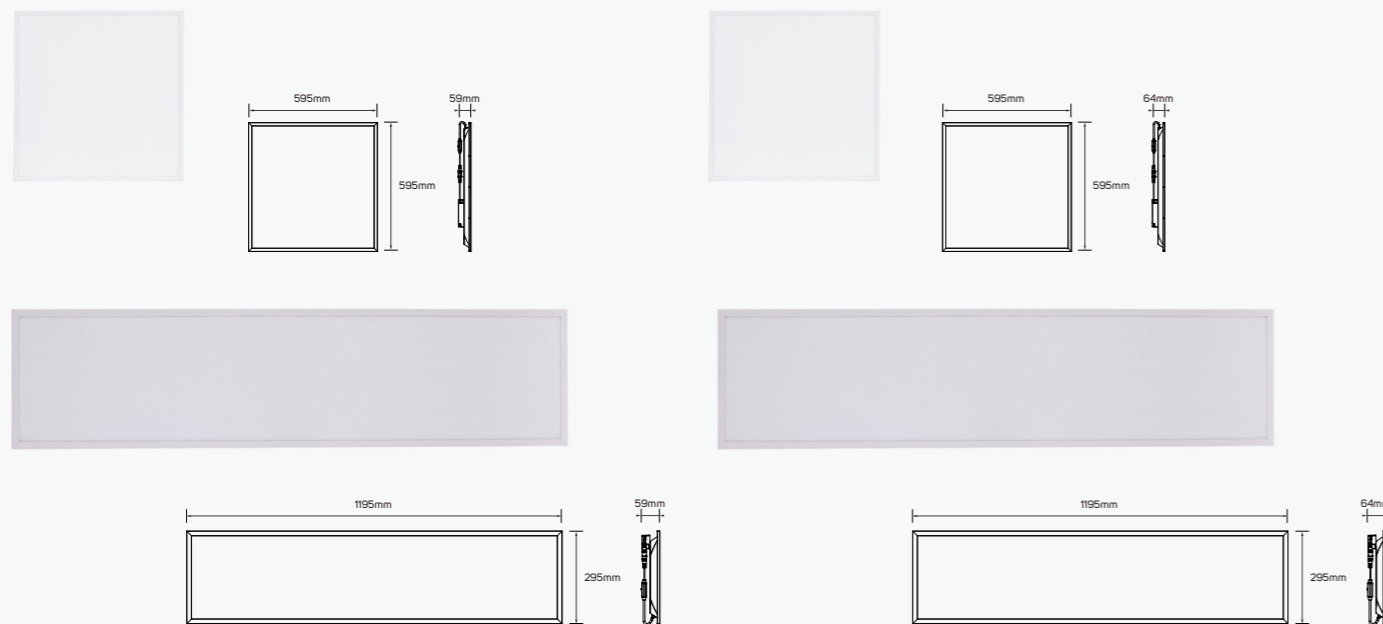
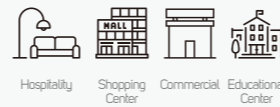

Family Product List

Code No.	Power	CCT	Lumen	Material
615529	36W	3000K/4000K/5700K	4200lm	Steel+Polystyrene
615530	50W	3000K/4000K/5700K	6200lm	
615531	36W	3000K/4000K/5700K	4300lm	
615532	50W	3000K/4000K/5700K	6400lm	

IP 20,44 CRI 95 120°
AC220-240V 50,000h

LED Panel

Technical Operating & Electrical Data

Input Voltage & Frequency	AC100-277V, 50/60Hz
Rated CRI	92
Beam Angle	120°
Dimming	Non-Dimmable
IP Rating	IP20
Body Material	Aluminum
Life Span	50000h

Areas of Application

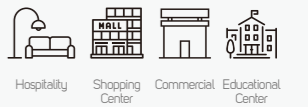

Accessories Specifications



Family Product List

Code No.	Power	CCT	Lumen	Material
612651	40W	3000K	4200lm	Aluminum
612652	40W	4000K	4300lm	
612653	40W	5700K	4400lm	
612654	40W	3000K	3100lm	
612655	40W	4000K	3150lm	
612656	40W	5700K	3200lm	

IP 20,40 CRI 92 120°
AC220-240V 50,000h

LED Waterproof Batten Luminaire

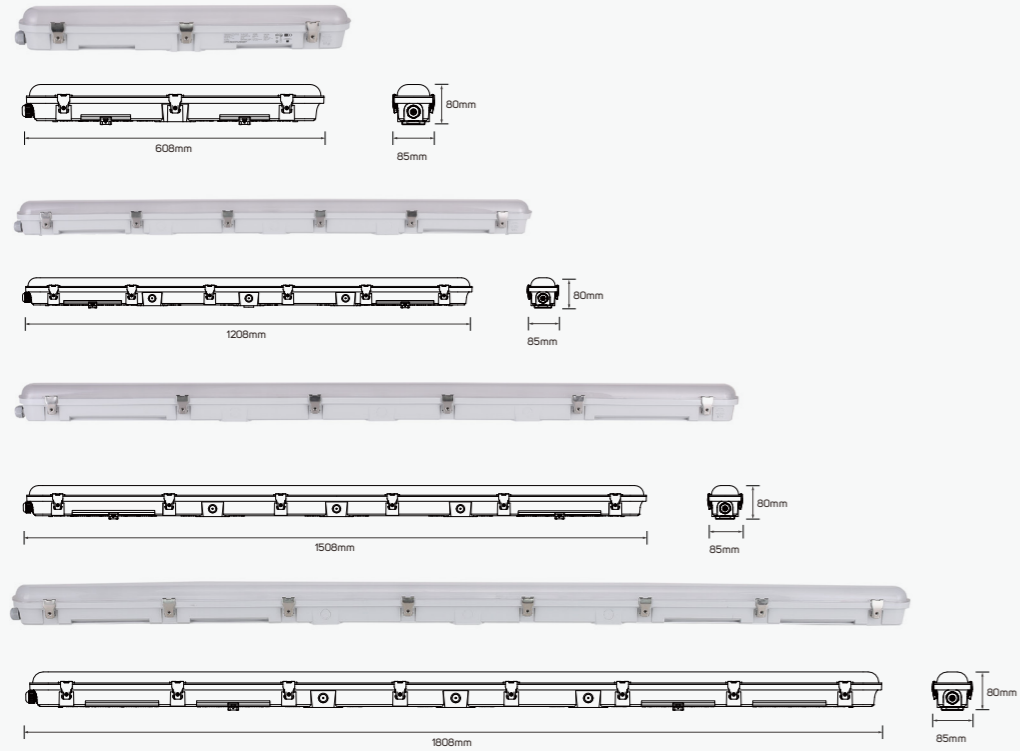

Family Product List

Code No.	Power	CCT	Lumen
615533	20W	3000K-4200K-6500K	2700lm
615534	40W	3000K-4200K-6500K	5300lm
615535	60W	3000K-4200K-6500K	8000lm
615536	70W	3000K-4200K-6500K	9300lm

Plastic
IP 65 CRI 90 **120°**
AC220-240V 50,000h

LED Waterproof Batten Luminaire

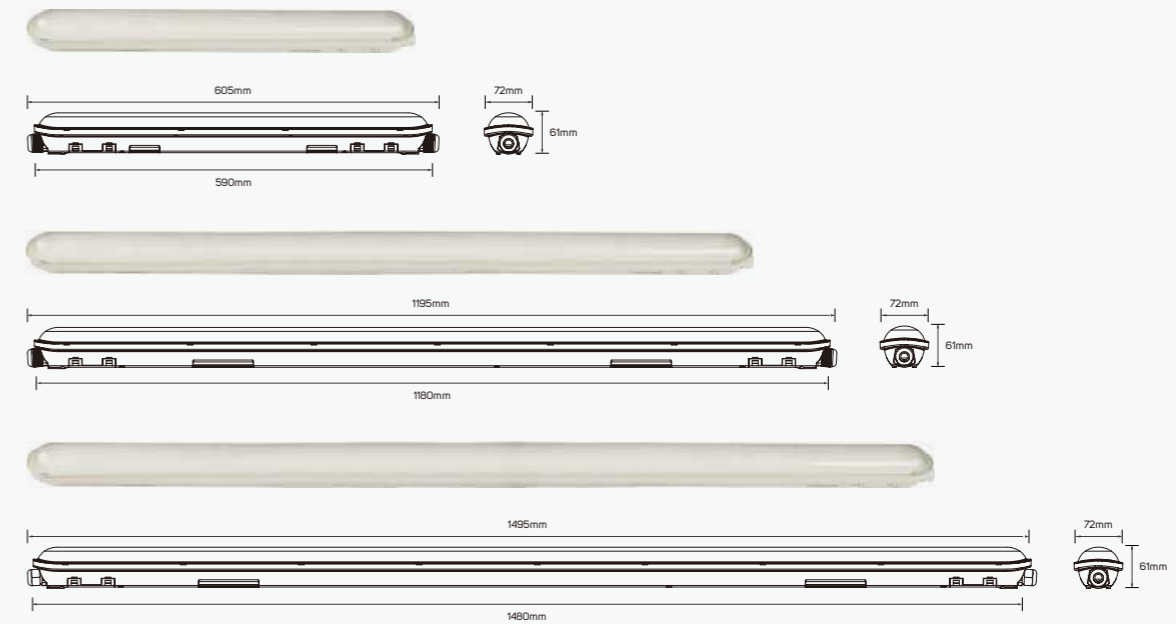

Family Product List

Code No.	Power	CCT	Lumen
612535	21W	3000K	2490lm
612536	21W	4000K	2590lm
612537	21W	6500K	2650lm
612538	40W	3000K	4800lm
612539	40W	4000K	4900lm
612540	40W	6500K	4980lm

Code No.	Power	CCT	Lumen
612541	55W	3000K	6600lm
612542	55W	4000K	6700lm
612543	55W	6500K	6800lm

Plastic
IP 65 CRI 80 **120°**
AC100-277V 40,000h

LED Waterproof Batten Luminaire

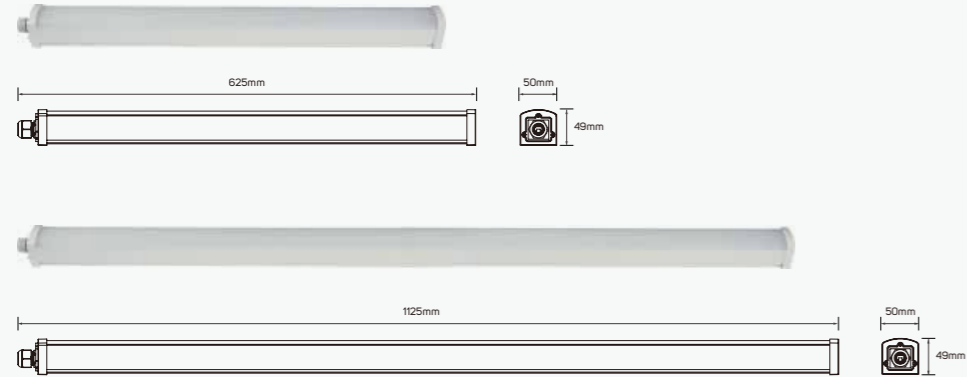

Family Product List

Code No.	Power	CCT	Lumen	Code No.	Power	CCT	Lumen
611625	18W	3000K	1660lm	611628	36W	3000K	3520lm
611626	18W	4000K	1720lm	611629	36W	4000K	3560lm
611627	18W	6500K	1780lm	611630	36W	6500K	3620lm

Plastic
IP 65 **CRI 80** **120°**
 AC220-240V

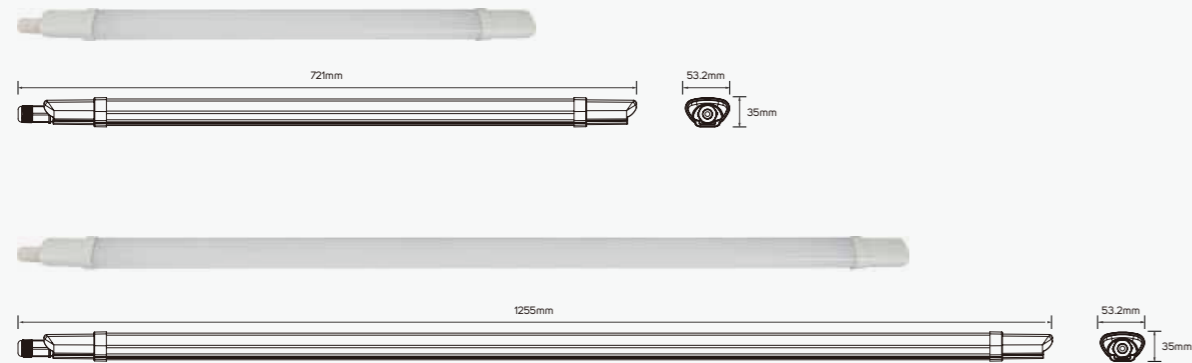

Family Product List

Code No.	Power	CCT	Lumen	Code No.	Power	CCT	Lumen
611619	18W	3000K	1560lm	611622	36W	3000K	3520lm
611620	18W	4000K	1680lm	611623	36W	4000K	3560lm
611621	18W	6500K	1620lm	611624	36W	6500K	3620lm

Plastic
IP 65 **CRI 80** **120°**
 AC220-240V 30,000h

Waterproof Batten Luminaire

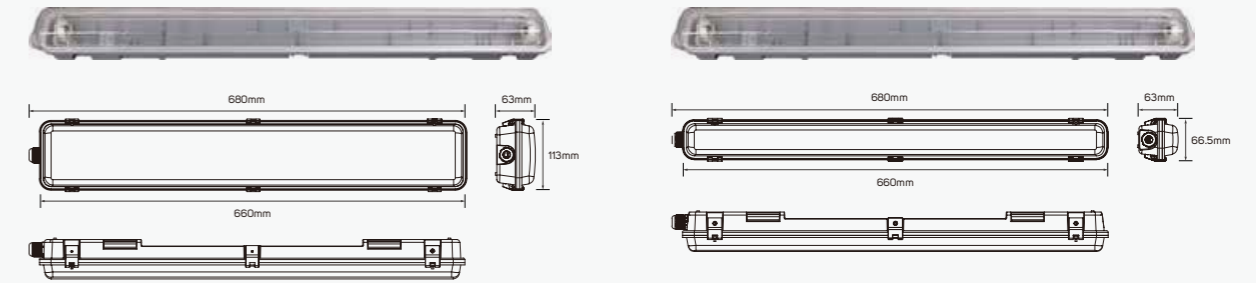

Family Product List

Code No.
611631
611632

ABS+PC Plastic
IP 65
 AC220-240V

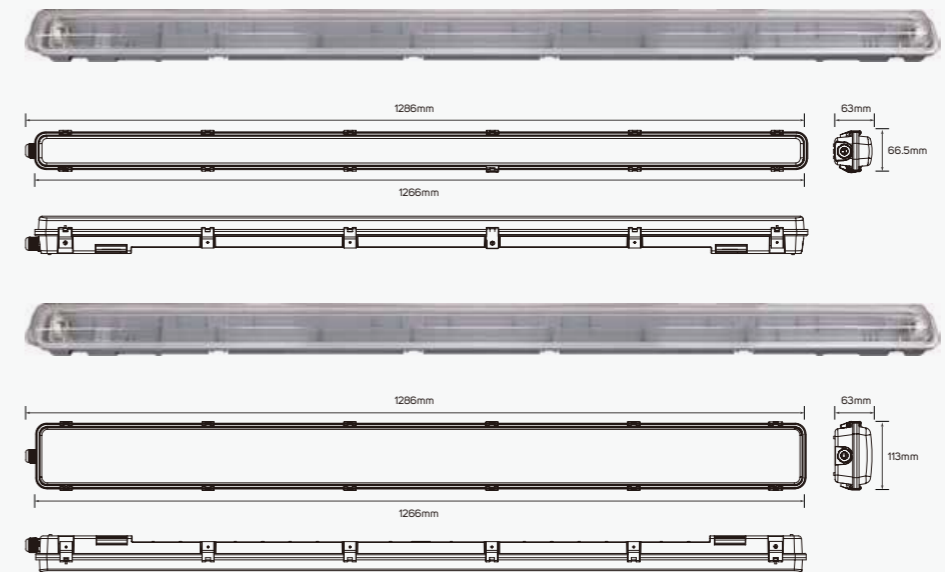

Family Product List

Code No.
611633
611634

ABS+PC Plastic
IP 65
 AC220-240V

Waterproof Batten Luminaire



Family Product List

Code No.

- 611635 ■ ABS+PC Plastic
 - 611636
- IP 65**
⏚ AC220-240V

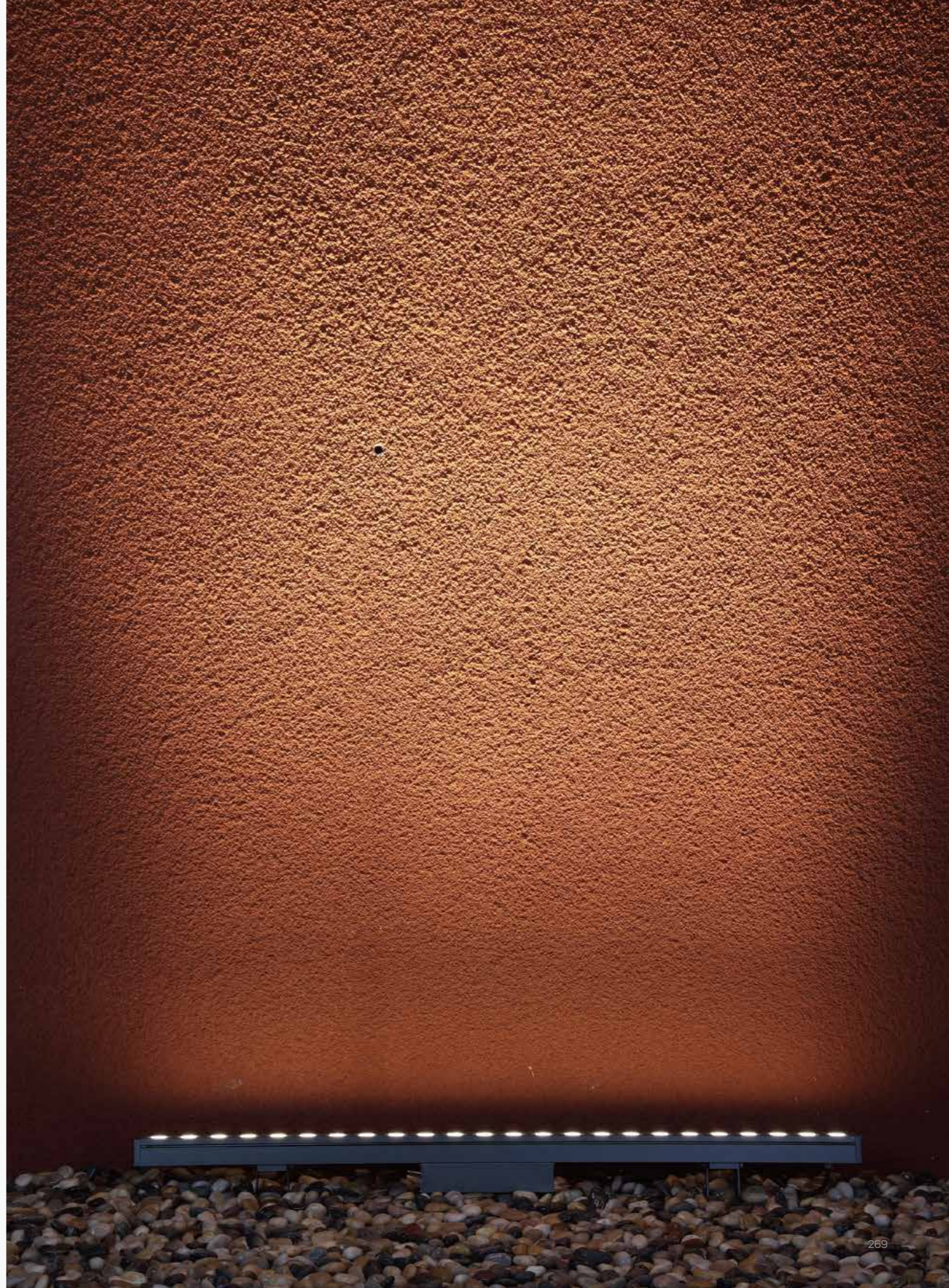



Efficient

Technical Operating & Electrical Data

Input Voltage & Frequency AC220-240V, 50/60Hz
 Body Color White

Areas Of Application

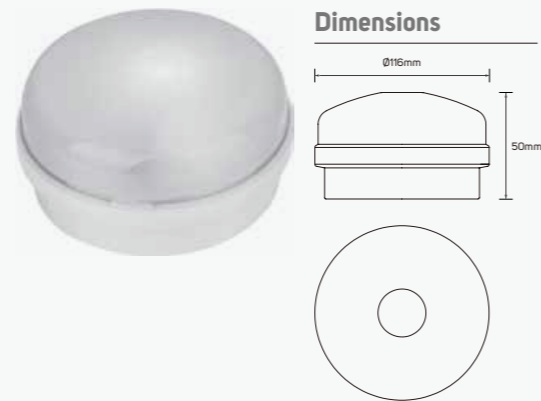
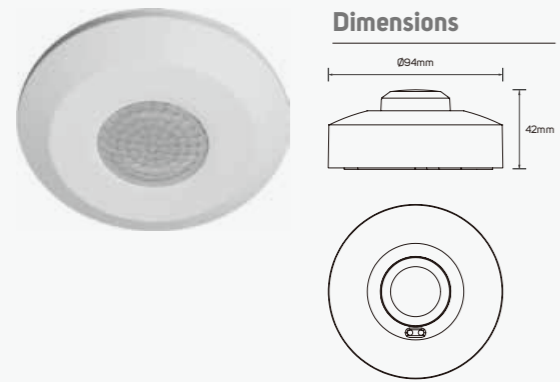
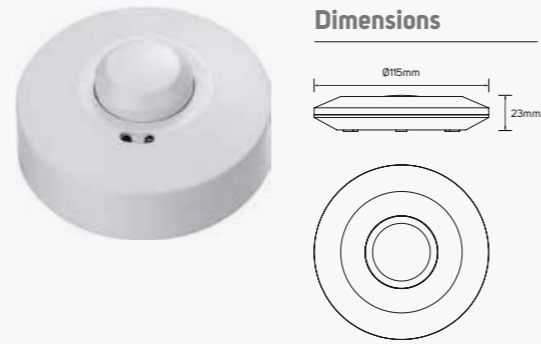
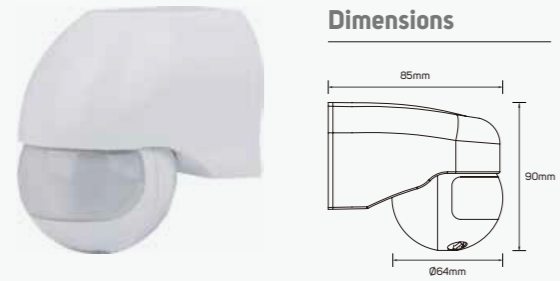
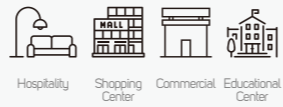

Family Product List

Code No.	Model No.	IP	Max.Watt	Material	Beam Angle	Detection Distance
612786	ILSSW8P01	44	200W	Polycarbonate	180°	6~8 Meter
612787	ILSSS6P01	20	200W	Polycarbonate	360°	Max 6 meter
612788	ILSSS10M01	20	300W	Polycarbonate	360°x160°	2~10 Meter
612789	ILSSS10M02	65	300W	Polycarbonate	360°x160°	2~10 Meter

Efficient

Technical Operating & Electrical Data

Input Voltage & Frequency AC220-240V, 50/60Hz
 Body Color White

Areas Of Application

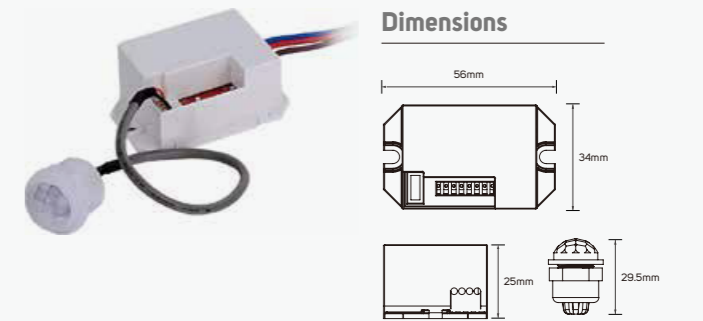
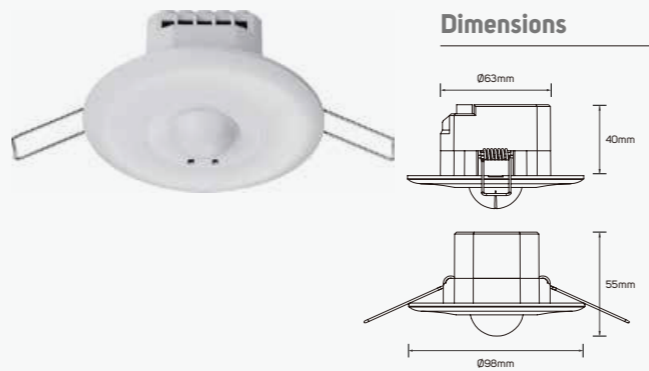
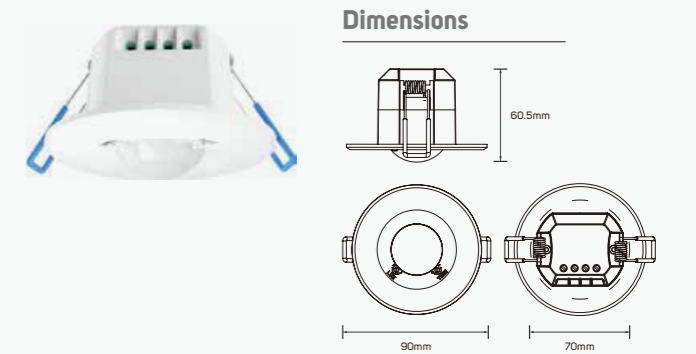
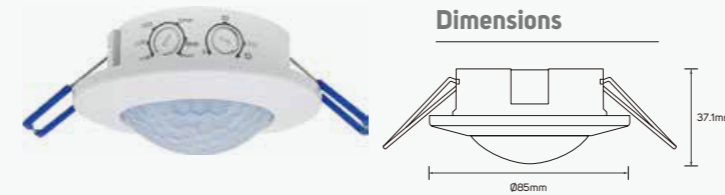
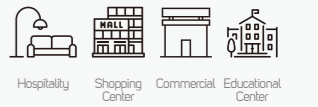

Family Product List

Code No.	Model No.	IP	Max.Watt	Material	Beam Angle	Detection Distance
612790	ILSSR6P01	20	200W	Polycarbonate	360°	Max 6 Meter
612791	ILSSR5P01	20	150W	Polycarbonate	360°	3x5 Meter
612792	ILSSR10M01	20	300W	Polycarbonate	360°x160°	2~10 Meter
612793	ILSSU6P01	20	200W	ABS	100°	<6 Meter
615446	ILSSU6P01	20	400W	PC	100°	Max. Meter



LED Emergency Light

Emergency light



● 612521

Accessories Specifications

Legend Board

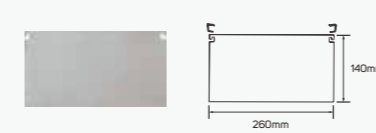

● 612522

■ Plastic

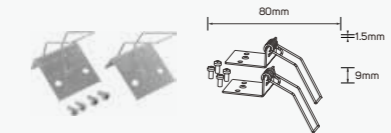

● 612526

■ Metal

Family Product List

■ Plastic

IP 65

CRI 80

AC220-240V

⌚ 50,000h

Code No.	Power	CCT	Lumen
● 612521	4.5W	5700K-6500K	120lm

Emergency light

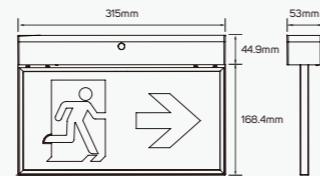

● 612527

Recessed Mounting Accessory

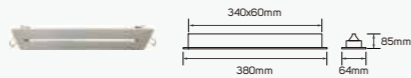

○ 612532

■ Plastic

Family Product List

■ Plastic

IP 20

CRI 80

AC220-240V

50,000h

Code No.	Power	CCT	Lumen
● 612527	3W	5700K-6500K	75lm

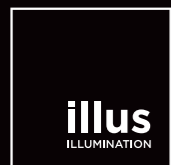

Contact Us

global@illuslighting.com

www.illuslighting.com

Find us in KSA, UAE, Oman, Kuwait, Qatar, Egypt, Spain, Bahrain, China.